

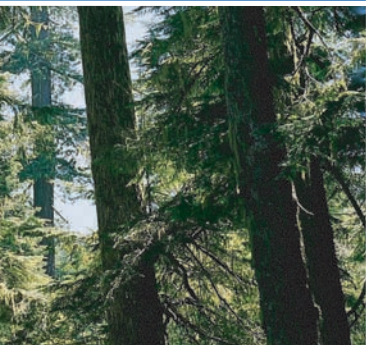

Husqvarna[®]



KEES VAN DER SPEK
TUINMACHINES ★ STOLWIJK

**Operator's manual, Manuel d'utilisation, Istruzioni per l'uso
Bedienungsanweisung, Instruções para o uso
Manual de instrucciones, Kullanım kılavuzu, Navodila za uporabo**

553RBX



Please read the operator's manual carefully and make sure you understand the instructions before using the machine.

Lire attentivement et bien assimiler le manuel d'utilisation avant d'utiliser la machine.

Prima di usare la macchina, leggere per intero le istruzioni per l'uso e accertarsi di averne compreso il contenuto.

Lesen Sie die Bedienungsanweisung sorgfältig durch und machen Sie sich mit dem Inhalt vertraut, bevor Sie das Gerät benutzen.

Leia as instruções para o uso com toda a atenção e compreenda o seu conteúdo antes de fazer uso da máquina.

Lea detenidamente el manual de instrucciones y asegúrese de entender su contenido antes de utilizar la máquina.

Makineyi kullanmadan önce kullanım kılavuzunu iyice okuyarak içeriğini kavrayınız.

Natančno preberite navodila za uporabo in se prepričajte, da ste jih razumeli, predno začnete z uporabo stroja..

GB (2-25)
FR (26-51)
IT (52-77)
DE (78-103)
PT (104-129)
ES (130-155)
TR (156-179)
SI (180-203)

KEY TO SYMBOLS

Symbols

WARNING! A clearing saw, brushcutter or trimmer can be dangerous if used incorrectly or carelessly, and can cause serious or fatal injury to the operator or others. It is extremely important that you read and understand the contents of this operator's manual.

Please read the operator's manual carefully and make sure you understand the instructions before using the machine.

Always wear:

- A protective helmet where there is a risk of falling objects
- Approved hearing protection
- Approved eye protection

Max. speed of output shaft, rpm

This product is in accordance with applicable EC directives.

Watch out for thrown objects and ricochets.

The operator of the machine must ensure, while working, that no persons or animals come closer than 15 metres.

Machines fitted with saw blades or grass blades can be thrown violently to the side when the blade comes into contact with a fixed object. This is called blade thrust. The blade is capable of amputating an arm or leg. Always keep people and animals at least 15 metres from the machine.

Arrows which show limits for handle positioning.

Ignition; choke: Set the choke control in the choke position. This should automatically set the stop switch to the start position.

Air purge.

Always wear approved protective gloves.



Wear sturdy, non-slip boots.



Only use non-metallic, flexible cutting attachments, i.e. trimmer heads with trimmer cord.



Noise emission to the environment according to the European Community's Directive. The machine's emission is specified in the Technical data chapter and on the label.



Keep all parts of your body away from hot surfaces.



Other symbols/decals on the machine refer to special certification requirements for certain markets.

Switch off the engine by moving the stop switch to the STOP position before carrying out any checks or maintenance.



Always wear approved protective gloves.



Regular cleaning is required.



Visual check.



CONTENTS

Contents

KEY TO SYMBOLS

Symbols 2

CONTENTS

Contents 3

Note the following before starting: 3

INTRODUCTION

Dear Customer, 4

WHAT IS WHAT?

What is what on the brush cutter? 5

GENERAL SAFETY PRECAUTIONS

Important 6

Personal protective equipment 6

Machine's safety equipment 7

Cutting equipment 9

ASSEMBLY

Fitting the flexible drive shaft 11

Connecting throttle cable and stop switch wires ... 11

Fitting the J-handle 11

Fitting blades and trimmer heads 12

Fitting the transport guard 13

Adjusting the harness and brush cutter 13

FUEL HANDLING

Fuel safety 15

Fuel 15

Fueling 16

STARTING AND STOPPING

Check before starting 17

Starting and stopping 17

WORKING TECHNIQUES

General working instructions 19

MAINTENANCE

Carburettor 21

Air filter 21

Fuel filter 21

Bevel gear 21

Spark plug 21

Drive shaft 22

Maintenance schedule 23

TECHNICAL DATA

Technical data 24

EC-declaration of conformity 25

Note the following before starting:

Please read the operator's manual carefully.



WARNING! Long-term exposure to noise can result in permanent hearing impairment. So always use approved hearing protection.



WARNING! Under no circumstances may the design of the machine be modified without the permission of the manufacturer. Always use original accessories. Non-authorized modifications and/or accessories can result in serious personal injury or the death of the operator or others.



WARNING! A clearing saw, brushcutter or trimmer can be dangerous if used incorrectly or carelessly, and can cause serious or fatal injury to the operator or others. It is extremely important that you read and understand the contents of this operator's manual.

KEES VAN DER SPEK
KES*STOLWIJK

INTRODUCTION

Dear Customer,

Congratulations on your choice to buy a Husqvarna product! Husqvarna is based on a tradition that dates back to 1689, when the Swedish King Karl XI ordered the construction of a factory on the banks of the Husqvarna River, for production of muskets. The location was logical, since water power was harnessed from the Husqvarna River to create the water-powered plant. During the more than 300 years in existence, the Husqvarna factory has produced a lot of different products, from wood stoves to modern kitchen appliances, sewing machines, bicycles, motorcycles etc. In 1956, the first motor driven lawn mowers appeared, followed by chain saws in 1959, and it is within this area Husqvarna is working today.

Today Husqvarna is one of the leading manufacturers in the world of forest and garden products, with quality as our highest priority. The business concept is to develop, manufacture and market motor-driven products for forestry and gardening, as well as for the building and construction industry. Husqvarna's aim is also to be at the front edge for ergonomics, usability, security and environmental protection. That is the reason why we have developed many different features to add to our products within these areas.

We are convinced that you will appreciate with great satisfaction the quality and performance of our product for a very long time to come. The purchase of one of our products gives you access to professional help with repairs and service whenever this may be necessary. If the retailer who sells your machine is not one of our authorised dealers, ask for the address of your nearest service workshop.

It is our wish that you will be satisfied with your product and that it will be your companion for a long time. Think of this operator's manual as a valuable document. By following its content (usage, service, maintenance, etc), the life span and the second-hand value of the machine can be extended. If you sell this machine, make sure that the operator's manual is passed on to the buyer.

Thank you for using a Husqvarna product.

Husqvarna AB has a policy of continuous product development and therefore reserves the right to modify the design and appearance of products without prior notice.

KEES VAN DER SPEK
TUINMACHINES ★ STOLWIJK

WHAT IS WHAT?

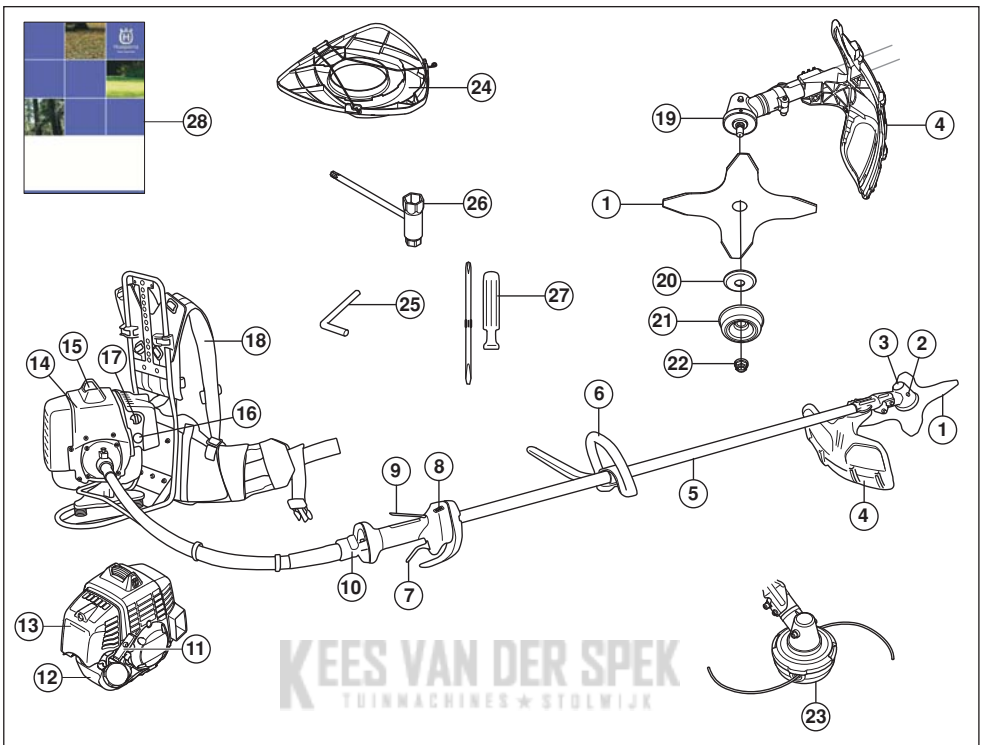

What is what on the brush cutter?

- | | | | |
|----|-------------------------------|----|-------------------------------|
| 1 | Blade | 15 | Spark plug cap and spark plug |
| 2 | Grease filler cap, bevel gear | 16 | Air purge. |
| 3 | Bevel gear | 17 | Choke control |
| 4 | Cutting attachment guard | 18 | Harness |
| 5 | Shaft | 19 | Drive disc |
| 6 | Loop handle | 20 | Support flange |
| 7 | Throttle trigger | 21 | Support cup |
| 8 | Stop switch | 22 | Locking nut |
| 9 | Throttle lockout | 23 | Trimmer head |
| 10 | Shaft coupling | 24 | Transport guard |
| 11 | Starter handle | 25 | Locking pin |
| 12 | Fuel tank | 26 | Socket spanner |
| 13 | Air filter cover | 27 | Screwdriver |
| 14 | Cylinder cover | 28 | Operator's manual |

GENERAL SAFETY PRECAUTIONS

Important

IMPORTANT!

The machine is only designed for grass trimming and grass clearing.

The only accessories you can operate with this engine unit are the cutting attachments we recommend in the chapter on Technical data.

Never use the machine if you are tired, if you have drunk alcohol, or if you are taking medication that could affect your vision, your judgement or your co-ordination.

Wear personal protective equipment. See instructions under the "Personal protective equipment" heading.

Never use a machine that has been modified in any way from its original specification.

Never use a machine that is faulty. Carry out the checks, maintenance and service instructions described in this manual. Some maintenance and service measures must be carried out by trained and qualified specialists. See instructions under the Maintenance heading.

All covers, guards and handles must be fitted before starting. Ensure that the spark plug cap and ignition lead are undamaged to avoid the risk of electric shock.

The machine operator must ensure that no people or animals come closer than 15 metres while working. When several operators are working in the same area the safety distance should be at least twice the tree height and no less than 15 metres.



WARNING! This machine produces an electromagnetic field during operation. This field may under some circumstances interfere with active or passive medical implants. To reduce the risk of serious or fatal injury, we recommend persons with medical implants to consult their physician and the medical implant manufacturer before operating this machine.



WARNING! Running an engine in a confined or badly ventilated area can result in death due to asphyxiation or carbon monoxide poisoning.



WARNING! Never allow children to use or be in the vicinity of the machine. As the machine is equipped with a spring-loaded stop switch and can be started by low speed and force on the starter handle, even small children under some circumstances can produce the force necessary to start the machine. This can mean a risk of serious personal injury. Therefore remove the spark plug cap when the machine is not under close supervision.

Personal protective equipment

IMPORTANT!

A clearing saw, brushcutter or trimmer can be dangerous if used incorrectly or carelessly, and can cause serious or fatal injury to the operator or others. It is extremely important that you read and understand the contents of this operator's manual.

You must use approved personal protective equipment whenever you use the machine. Personal protective equipment cannot eliminate the risk of injury but it will reduce the degree of injury if an accident does happen. Ask your dealer for help in choosing the right equipment.



WARNING! Listen out for warning signals or shouts when you are wearing hearing protection. Always remove your hearing protection as soon as the engine stops.

HELMET

A protective helmet where there is a risk of falling objects



HEARING PROTECTION

Wear hearing protection that provides adequate noise reduction.



EYE PROTECTION

Always wear approved eye protection. If you use a visor then you must also wear approved protective goggles. Approved protective goggles must comply with the ANSI Z87.1 standard in the USA or EN 166 in EU countries.



GENERAL SAFETY PRECAUTIONS

GLOVES

Gloves should be worn when necessary, e.g. when fitting cutting attachments.



BOOTS

Wear sturdy, non-slip boots.



CLOTHING

Wear clothes made of a strong fabric and avoid loose clothing that can catch on twigs and branches. Always wear heavy, long pants. Do not wear jewellery, shorts sandals or go barefoot. Secure hair so it is above shoulder level.

FIRST AID KIT

Always have a first aid kit nearby.



Machine's safety equipment

This section describes the machine's safety equipment, its purpose, and how checks and maintenance should be carried out to ensure that it operates correctly. See the "What is what?" section to locate where this equipment is positioned on your machine.

The life span of the machine can be reduced and the risk of accidents can increase if machine maintenance is not carried out correctly and if service and/or repairs are not carried out professionally. If you need further information please contact your nearest service workshop.

IMPORTANT! All servicing and repair work on the machine requires special training. This is especially true of the machine's safety equipment. If your machine fails any of the checks described below you must contact your service agent. When you buy any of our products we guarantee the availability of professional repairs and service. If the retailer who sells your machine is not a servicing dealer, ask him for the address of your nearest service agent.



WARNING! Never use a machine with faulty safety equipment. The machine's safety equipment must be checked and maintained as described in this section. If your machine fails any of these checks contact your service agent to get it repaired.

Throttle lockout

The throttle lockout is designed to prevent accidental operation of the throttle control. When you press the lock (A) (i.e. when you grasp the handle) it releases the throttle control (B). When you release the handle the throttle control and the throttle lockout both move back to their original positions. This movement is controlled by two independent return springs. This arrangement means that the throttle control is automatically locked at the idle setting.

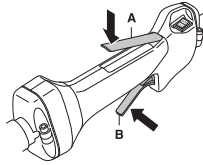

Make sure the throttle control is locked at the idle setting when the throttle lockout is released.

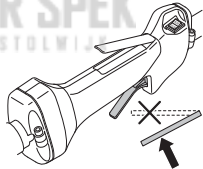

Press the throttle lockout and make sure it returns to its original position when you release it.

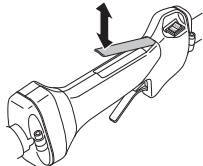

Check that the throttle trigger and throttle lockout move freely and that the return springs work properly.

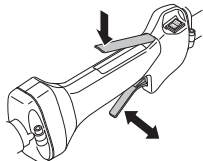

See instructions under the heading Start. Start the machine and apply full throttle. Release the throttle and check that the cutting attachment stops and remains at a

GENERAL SAFETY PRECAUTIONS

standstill. If the cutting attachment rotates with the throttle in the idle position then the carburettor idle setting must be checked. See instructions under the heading Maintenance.

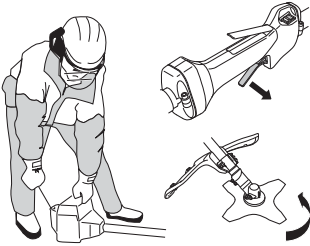

Stop switch

Use the stop switch to switch off the engine.

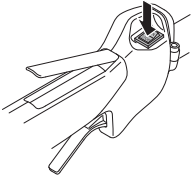

Start the engine and make sure the engine stops when you move the stop switch to the stop setting.

Cutting attachment guard

This guard is intended to prevent loose objects from being thrown towards the operator. The guard also protects the operator from accidental contact with the cutting attachment.

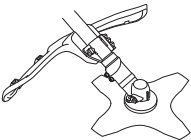

Check that the guard is undamaged and not cracked. Replace the guard if it has been exposed to impact or is cracked.

Always use the recommended guard for the cutting attachment you are using. See chapter on Technical data.



WARNING! Never use a cutting attachment without an approved guard. See the chapter on Technical data. If an incorrect or faulty guard is fitted this can cause serious personal injury.

Vibration damping system

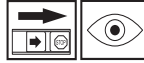

Your machine is equipped with a vibration damping system that is designed to minimize vibration and make operation easier.



Using incorrectly wound cord or a blunt or incorrect cutting attachment (wrong type or incorrectly filed, see instructions under the heading Filing the blade) increases the level of vibration.

The machine's vibration damping system reduces the transfer of vibration between the engine unit/cutting equipment and the machine's handle unit.

Regularly check the vibration damping units for cracks or deformation. Check that the vibration damping element is undamaged and securely attached.



WARNING! Overexposure to vibration can lead to circulatory damage or nerve damage in people who have impaired circulation. Contact your doctor if you experience symptoms of overexposure to vibration. Such symptoms include numbness, loss of feeling, tingling, pricking, pain, loss of strength, changes in skin colour or condition. These symptoms normally appear in the fingers, hands or wrists. The risk increases at low temperatures.

Muffler

The muffler is designed to keep noise levels to a minimum and to direct exhaust fumes away from the user. A muffler fitted with a catalytic converter is also designed to reduce harmful exhaust gases.

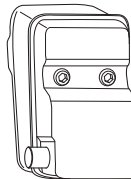

GENERAL SAFETY PRECAUTIONS

Never use a machine that has a faulty muffler.

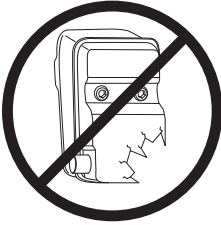

Regularly check that the muffler is securely attached to the machine.

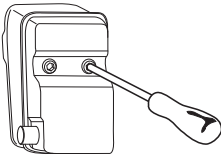

If the muffler on your machine is fitted with a spark arrester mesh this must be cleaned regularly. A blocked mesh will cause the engine to overheat and may lead to serious damage.



WARNING! Mufflers fitted with catalytic converters get very hot during use and remain so for some time after stopping. This also applies at idle speed. Contact can result in burns to the skin. Remember the risk of fire!



WARNING! The inside of the muffler contain chemicals that may be carcinogenic. Avoid contact with these elements in the event of a damaged muffler.



WARNING! Bear in mind that: The exhaust fumes from the engine are hot and may contain sparks which can start a fire. Never start the machine indoors or near combustible material!

Locking nut

A locking nut is used to secure some types of cutting attachment.



When fitting, tighten the nut in the opposite direction to the direction of rotation of the cutting attachment. To remove it, undo the nut in the same direction as the cutting attachment rotates. (CAUTION! The nut has a left-hand thread.) Tighten the nut using the socket spanner.

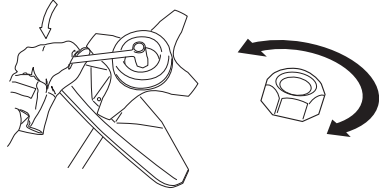

The nylon lining inside the locking nut must not be so worn that you can turn it by hand. The lining should offer a resistance of at least 1.5 Nm. The nut should be replaced after it has been put on approx. 10 times.

Harness

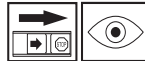

Check that the harness is not damaged.

In an emergency situation, release yourself from machine and harness according to the following method.

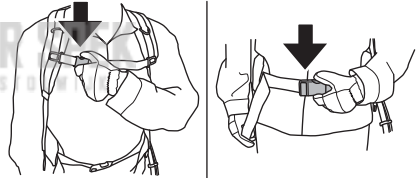

Cutting equipment

This section describes how to choose and maintain your cutting equipment in order to:

- Reduce the risk of blade thrust.
- Obtain maximum cutting performance.
- Extend the life of cutting equipment.

IMPORTANT!

Only use cutting attachments with the guards we recommend! See the chapter on Technical data.

Refer to the instructions for the cutting attachment to check the correct way to load the cord and the correct cord diameter.

Keep the teeth of the blade correctly sharpened! Follow our recommendations. Also refer to the instructions on the blade packaging.

GENERAL SAFETY PRECAUTIONS



WARNING! Always stop the engine before doing any work on the cutting attachment. This continues to rotate even after the throttle has been released. Ensure that the cutting attachment has stopped completely and disconnect the HT lead from the spark plug before you start to work on it.



WARNING! Using an incorrect cutting attachment or an incorrectly sharpened blade increases the risk of blade thrust.

Cutting equipment

Grass blades and grass knives are intended for cutting coarse grass.

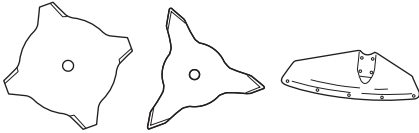

A trimmer head is intended for trimming grass.



General rules



Only use cutting attachments with the guards we recommend! See the chapter on Technical data.

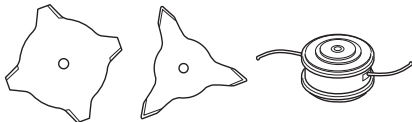

Keep the teeth of the blade correctly sharpened! Follow our instructions and use the recommended file gauge. An incorrectly sharpened or damaged blade increases the risk of accidents.

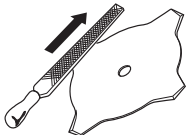

Check the cutting attachment for damage or cracks. A damaged cutting attachment should always be replaced.

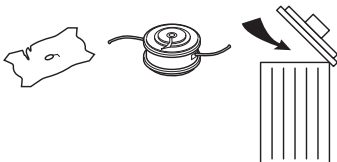

Sharpening grass knives and grass blades



- See the cutting attachment packaging for correct sharpening instructions. Sharpen blades and knives using a single-cut flat file.
- Sharpen all edges equally to maintain the balance of the blade.

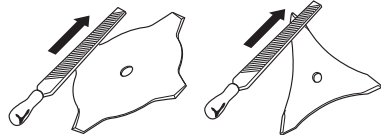

WARNING! Always discard a blade that is bent, twisted, cracked, broken or damaged in any other way. Never attempt to straighten a twisted blade so that it can be reused. Only use original blades of the specified type.

Trimmer head

IMPORTANT!

Always ensure the trimmer cord is wound tightly and evenly around the drum, otherwise the machine will generate harmful vibration.

- Only use the recommended trimmer heads and trimmer cords. These have been tested by the manufacturer to suit a particular engine size. This is especially important when a fully automatic trimmer head is used. Only use the recommended cutting attachment. See the chapter on Technical data.



- Smaller machines generally require small trimmer heads and vice versa. This is because when clearing using a cord the engine must throw out the cord radially from the trimmer head and overcome the resistance of the grass being cleared.
- The length of the cord is also important. A longer cord requires greater engine power than a shorter cord of the same diameter.
- Make sure that the cutter on the trimmer guard is intact. This is used to cut the cord to the correct length.
- To increase the life of the cord it can be soaked in water for a couple of days. This will make the line tougher so that it lasts longer.

ASSEMBLY

Fitting the flexible drive shaft



- Loosen two screws at the shaft coupling.

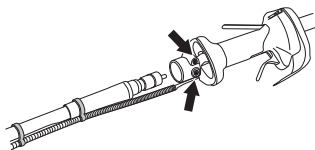

- Slide the flexible shaft through the loops at the cabling, and fit the flexible shaft to the shaft coupling. Make sure the shaft engages correctly by turning it and pushing at the same time.
- Tighten the two screws.
- Install the drive shaft sleeve in the clutch cover so that the hole is positioned directly underneath the locking button on the clutch cover.

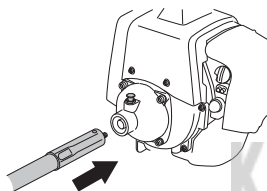

- Make sure the shaft engages correctly by turning it and pushing at the same time.
- Make sure the locking pin returns to its original position, so that the drive shaft sleeve cannot come off the clutch case.

Connecting throttle cable and stop switch wires



- Place the throttle wire from the cabling (A) and the throttle wire from the engine (B) in the plastic sleeve as shown.

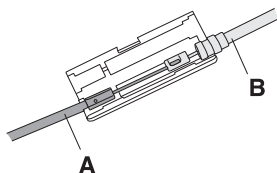

- Close the plastic sleeve.

- Plug the stop switch wires into the matching connectors from the engine. Note that wire polarity is not important.

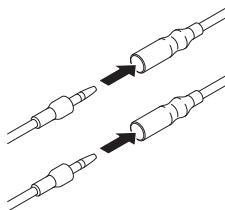

Fitting the J-handle



- Position the handle on the shaft. Note that the handle must be mounted below the arrow on the shaft.

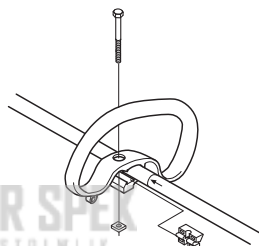

- Slide the spacer into the slot in the loop handle.
- Fit the nut and screw. Do not overtighten.
- Attach the J-handle to the loop handle using the three screws, as shown.

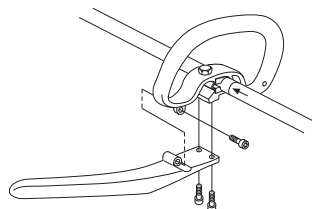

ASSEMBLY

- Now adjust the trimmer to give a comfortable working position. Tighten the bolt/knob.

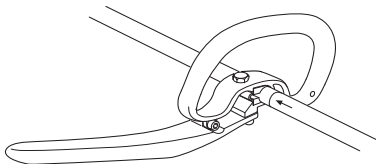

WARNING! Only grass blades/grass cutters or trimmer heads/plastic blades may be used when the J-handle is fitted. Saw blades must never be used with the J-handle.

Fitting blades and trimmer heads



WARNING! When fitting the cutting attachment it is extremely important that the raised section on the drive disc/support flange engages correctly in the centre hole of the cutting attachment. If the cutting attachment is fitted incorrectly it can result in serious and/or fatal personal injury.



WARNING! Never use a cutting attachment without an approved guard. See the chapter on Technical data. If an incorrect or faulty guard is fitted this can cause serious personal injury.

IMPORTANT! If a saw blade or grass blade are to be used the machine must be equipped with the correct handlebar, blade guard and harness.

Fitting the guard extension



CAUTION! The guard extension shall always be fitted when using the trimmer head/plastic blades and combination guard. The guard extension shall always be removed when using the grass blade and combination guard.

Hook the blade guard/combination guard (A) onto the fitting on the shaft and secure with the bolt.

Enter the guard extension guide in the slot of the combination guard. Then click the guard extension into position on the guard with the four quick-fasteners.

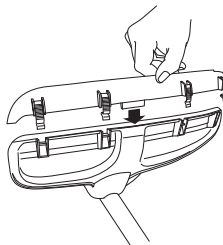

The guard extension is removed easily using a screwdriver, see illustration.

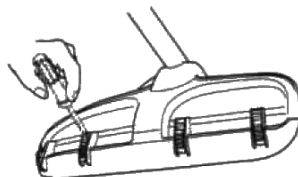

Fitting a blade guard, grass blade and grass cutter



- Hook the blade guard/combination guard (A) onto the fitting on the shaft and secure with the bolt (L). Use the recommended blade guard. See the Technical data section. **CAUTION!** Ensure that the guard extension is removed.

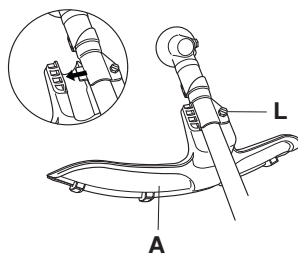

- Fit the drive disc (B) on the output shaft.
- Turn the blade shaft until one of the holes in the drive disc aligns with the corresponding hole in the gear housing.
- Insert the locking pin (C) in the hole to lock the shaft.
- Place the blade (D), support cup (E) and support flange (F) on the output shaft.
- Fit the nut (G). The nut must be tightened to a torque of 35-50 Nm (3.5-5 kpm). Use the socket spanner in the tool kit. Hold the shaft of the spanner as close to the blade guard as possible. To tighten the nut, turn

ASSEMBLY

the spanner in the opposite direction to the direction of rotation (Caution! left-hand thread).

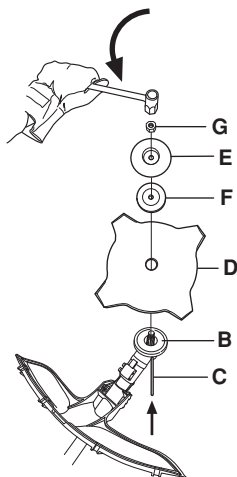

Fitting the trimmer guard and trimmer head



- Fit the correct trimmer guard (A) for use with the trimmer head. CAUTION! Ensure that the guard extension is fitted.

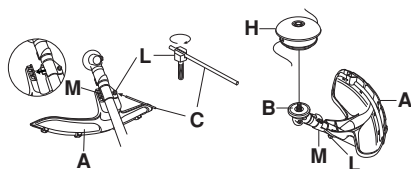

- Hook the trimmer guard/combination guard onto the fitting on the shaft and secure with the bolt (L).
- Fit the drive disc (B) on the output shaft.
- Turn the blade shaft until one of the holes in the drive disc aligns with the corresponding hole in the gear housing.
- Insert the locking pin (C) in the hole to lock the shaft.
- Screw on the trimmer head/plastic blades (H) in the opposite direction to the direction of rotation.

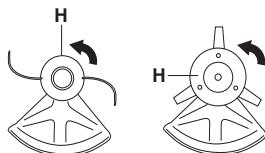

- To dismantle, follow the instructions in the reverse order.

Fitting the transport guard



- Insert the blade in the transport guard (A).
- Snap the two fasteners (B) into the slots (C) to secure the transport guard.

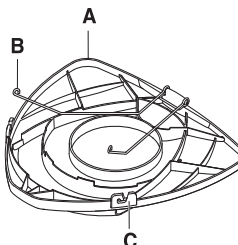

Adjusting the harness and brush cutter



Adjusting the backplate height

- Loosen the two fasteners holding the backplate.

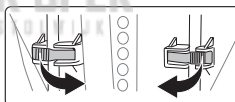

- Loosen the backplate from the frame on one side.

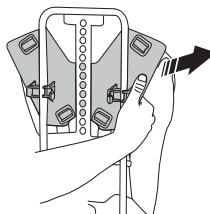

ASSEMBLY

- Move the backplate to the desired height and fasten it. Make sure the pin aligns with one of the holes on the frame, see picture.

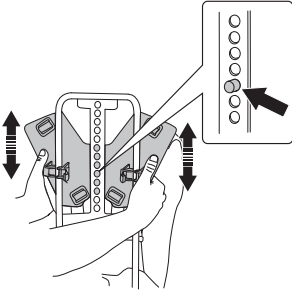

- Adjust the shoulder straps to distribute the load evenly across your shoulders.



- Loosen or tighten the waist strap so that approx. 70% of the load is on your waist and 30% on your shoulders.

Adjusting the harness

- Put on the harness.
- Tighten the waist strap so that it sits securely.



- Tighten the chest strap.



- Adjust the chest strap vertically if needed and make sure it fits well.

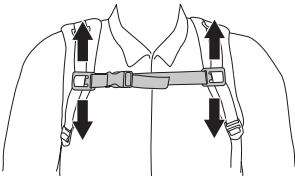

KEES VAN DER SPEK
TUINMACHINES * STOLWIJK

FUEL HANDLING

Fuel safety

Never start the machine:

- 1 If you have spilt fuel on it. Wipe off the spillage and allow remaining fuel to evaporate.
- 2 If you have spilt fuel on yourself or your clothes, change your clothes. Wash any part of your body that has come in contact with fuel. Use soap and water.
- 3 If the machine is leaking fuel. Check regularly for leaks from the fuel cap and fuel lines.

Transport and storage

- Store and transport the machine and fuel so that there is no risk of any leakage or fumes coming into contact with sparks or naked flames, for example, from electrical machinery, electric motors, electrical relays/switches or boilers.
- When storing and transporting fuel always use approved containers intended for this purpose.
- When storing the machine for long periods the fuel tank must be emptied. Contact your local petrol station to find out where to dispose of excess fuel.
- Ensure the machine is cleaned and that a complete service is carried out before long-term storage.
- The transport guard must always be fitted to the cutting attachment when the machine is being transported or in storage.
- Secure the machine during transport.



WARNING! Take care when handling fuel. Bear in mind the risk of fire, explosion and inhaling fumes.

Fuel

CAUTION! The machine is equipped with a two-stroke engine and must always be run using a mixture of petrol and two-stroke oil. It is important to accurately measure the amount of oil to be mixed to ensure that the correct mixture is obtained. When mixing small amounts of fuel, even small inaccuracies can drastically affect the ratio of the mixture.



WARNING! Fuel and fuel fumes are highly inflammable and can cause serious injury when inhaled or allowed to come in contact with the skin. For this reason observe caution when handling fuel and make sure there is adequate ventilation.

Petrol



CAUTION! Always use a quality petrol/oil mixture at least 90 octane (RON). If your machine is equipped with a catalytic converter (see chapter on Technical data) always use a good quality unleaded petrol/oil mixture. Leaded petrol will destroy the catalytic converter.

Use low-emission petrol, also known as alkylate petrol, if it is available.

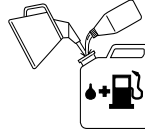

- The lowest octane recommended is 90 (RON). If you run the engine on a lower octane grade than 90 so-called knocking can occur. This gives rise to a high engine temperature, which can result in serious engine damage.
- When working at continuous high revs a higher octane rating is recommended.

Two-stroke oil

- For best results and performance use HUSQVARNA two-stroke engine oil, which is specially formulated for our air-cooled two-stroke engines.
- Never use two-stroke oil intended for water-cooled engines, sometimes referred to as outboard oil (rated TCW).
- Never use oil intended for four-stroke engines.
- A poor oil quality and/or too high oil/fuel ratio may jeopardise function and decrease the life time of catalytic converters.
- Mixing ratio
1:50 (2%) with HUSQVARNA two-stroke oil.
1:33 (3%) with oils class JASO FB or ISO EGB formulated for air-cooled, two-stroke engines.

Petrol, litre	Two-stroke oil, litre	
	2% (1:50)	3% (1:33)
5	0,10	0,15
10	0,20	0,30
15	0,30	0,45
20	0,40	0,60

FUEL HANDLING

Mixing

- Always mix the petrol and oil in a clean container intended for fuel.
- Always start by filling half the amount of the petrol to be used. Then add the entire amount of oil. Mix (shake) the fuel mixture. Add the remaining amount of petrol.
- Mix (shake) the fuel mixture thoroughly before filling the machine's fuel tank.

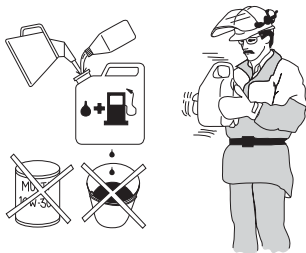

- Do not mix more than one month's supply of fuel at a time.
- If the machine is not used for some time the fuel tank should be emptied and cleaned.



WARNING! The catalytic converter muffler gets very hot during and after use. This also applies during idling. Be aware of the fire hazard, especially when working near flammable substances and/or vapours.

Fueling



WARNING! Taking the following precautions, will lessen the risk of fire:

Do not smoke or place hot objects near fuel.

Always shut off the engine before refuelling.

Always stop the engine and let it cool for a few minutes before refuelling.

When refuelling, open the fuel cap slowly so that any excess pressure is released gently.

Tighten the fuel cap carefully after refuelling.

Always move the machine away from the refuelling area and source before starting.

- Always use a fuel container with an anti-spill valve.
- Clean the area around the fuel cap. Contamination in the tank can cause operating problems.
- Ensure that the fuel is well mixed by shaking the container before filling the tank.

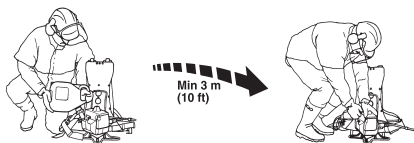

STARTING AND STOPPING

Check before starting



- Never use the machine without a guard nor with a defective guard.
- All covers must be correctly fitted and undamaged before you start the machine.
- Check the blade to ensure that no cracks have formed at the bottom of the teeth or by the centre hole. The most common reason why cracks are formed is that sharp corners have been formed at the bottom of the teeth while sharpening or that the blade has been used with dull teeth. Discard a blade if cracks are found.

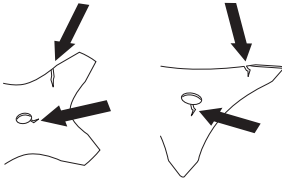

- Check that the support flange is not cracked due to fatigue or due to being tightened too much. Discard the support flange if it is cracked.

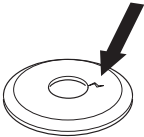

- Ensure the locking nut has not lost its captive force. The nut lock should have a locking force of at least 1.5 Nm. The tightening torque of the locking nut should be 35-50 Nm.



- Check that the blade guard is not damaged or cracked. Replace the blade guard if it is exposed to impact or is cracked.

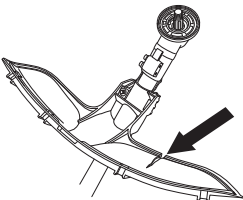

- Check that the trimmer head and trimmer guard are not damaged or cracked. Replace the trimmer head or

trimmer guard if they have been exposed to impact or are cracked.

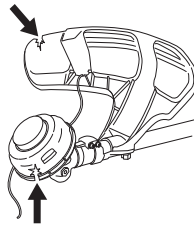

Starting and stopping



WARNING! The complete clutch cover and shaft must be fitted before the machine is started, otherwise the clutch can come loose and cause personal injury.

Always move the machine away from the refuelling area and source before starting. Place the machine on a flat surface. Ensure the cutting attachment cannot come into contact with any object.

Make sure no unauthorised persons are in the working area. Otherwise there is a risk of serious personal injury. The safety distance is 15 metres.

Starting



Ignition: Set the stop switch to the start position.

Primer bulb: Press the air purge repeatedly until fuel begins to fill the bulb. The bulb need not be completely filled.

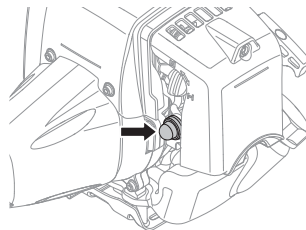

STARTING AND STOPPING

Choke: Set the choke control in the choke position.

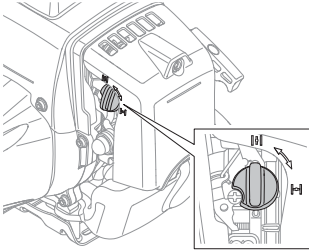

WARNING! When the engine is started with the choke in either the choke or start throttle positions the cutting attachment will start to rotate immediately.

Hold the body of the machine on the ground using your left hand (CAUTION! Not with your foot!). Grip the starter handle, slowly pull out the cord with your right hand until you feel some resistance (the starter pawls grip), now quickly and powerfully pull the cord. **Never twist the starter cord around your hand.**

Repeat pulling the cord until the engine starts. When the engine starts, return choke control to run position and apply full throttle; the throttle will automatically disengage from the start setting.

CAUTION! Do not pull the starter cord all the way out and do not let go of the starter handle when the cord is fully extended. This can damage the machine.

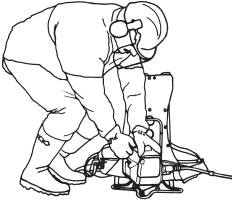

CAUTION! Do not put any part of your body in marked area. Contact can result in burns to the skin, or electrical shock if the spark plug cap has been damaged. Always use gloves. Do not use a machine with damaged spark plug cap.

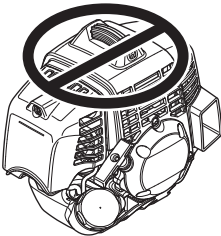

Stopping



Stop the engine by switching off the ignition.

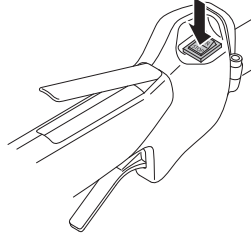

WORKING TECHNIQUES

General working instructions

IMPORTANT!

This section describes the basic safety precautions for working with brush cutters and trimmers.

If you encounter a situation where you are uncertain how to proceed you should ask an expert. Contact your dealer or your service workshop.

Avoid all usage which you consider to be beyond your capability.

You must understand the difference between forestry clearing, grass clearing and grass trimming before use.

Basic safety rules



- 1 Look around you:
 - To ensure that people, animals or other things cannot affect your control of the machine.
 - To ensure that people, animals, etc., do not come into contact with the cutting attachment or loose objects that are thrown out by the cutting attachment.
 - CAUTION! Do not use the machine unless you are able to call for help in the event of an accident.
- 2 Inspect the working area. Remove all loose objects, such as stones, broken glass, nails, steel wire, string, etc. that could be thrown out or become wrapped around the cutting attachment.
- 3 Do not use the machine in bad weather, such as dense fog, heavy rain, strong wind, intense cold, etc. Working in bad weather is tiring and often brings added risks, such as icy ground, unpredictable felling direction, etc.
- 4 Make sure you can move and stand safely. Check the area around you for possible obstacles (roots, rocks, branches, ditches, etc.) in case you have to move suddenly. Take great care when working on sloping ground.



- 5 Always carry this backpack type blower in its shoulder harness while operating.
- 6 Keep a good balance and a firm foothold.
- 7 Always hold the machine with both hands.
- 8 Keep the cutting attachment below waist level.
- 9 Switch off the engine before moving to another area. Fit the transport guard before carrying or transporting the equipment any distance.

- 10 Never put the machine down with the engine running unless you have it in clear sight.



WARNING! Neither the operator of the machine nor anyone else may attempt to remove the cut material while the engine is running or the cutting equipment is rotating, as this can result in serious injury.

Stop the engine and cutting equipment before you remove material that has wound around the blade shaft as otherwise there is a risk of injury. The bevel gear can get hot during use and may remain so for a while afterwards. You could get burnt if you touch it.



WARNING! Watch out for thrown objects. Always wear approved eye protection. Never lean over the cutting attachment guard. Stones, rubbish, etc. can be thrown up into the eyes causing blindness or serious injury.

Keep unauthorised persons at a distance. Children, animals, onlookers and helpers should be kept outside the safety zone of 15 metres. Stop the machine immediately if anyone approaches. Never swing the machine around without first checking behind you to make sure no-one is within the safety zone.

Basic working techniques

Always slow the engine to idle speed after each working operation. Long periods at full throttle without any load on the engine can lead to serious engine damage.



WARNING! Sometimes branches or grass get caught between the guard and cutting attachment. Always stop the engine before cleaning.



WARNING! Machines fitted with saw blades or grass blades can be thrown violently to the side when the blade comes into contact with a fixed object. This is called blade thrust. A blade thrust can be violent enough to cause the machine and/or operator to be propelled in any direction, and possibly lose control of the machine. Blade thrust can occur without warning if the machine snags, stalls or binds. Blade thrust is more likely to occur in areas where it is difficult to see the material being cut.

Avoid cutting with the area of the blade between the 12 o'clock and 3 o'clock positions. Because of the speed of rotation of the blade, blade thrust can occur if you attempt to cut thick stems with this area of the blade.

WORKING TECHNIQUES

Grass clearing using a grass blade



- Grass blades and grass knives must not be used on woody stems.
- A grass blade is used for all types of tall or coarse grass.
- The grass is cut down with a sideways, swinging movement, where the movement from right-to-left is the clearing stroke and the movement from left-to-right is the return stroke. Let the left-hand side of the blade (between 8 and 12 o'clock) do the cutting.

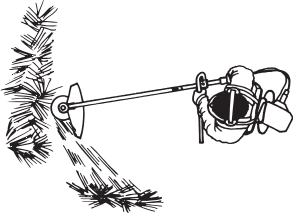

- If the blade is angled to the left when clearing grass, the grass will collect in a line, which makes it easier to collect, e.g. by raking.
- Try to work rhythmically. Stand firmly with your feet apart. Move forward after the return stroke and stand firmly again.
- Let the support cup rest lightly against the ground. It is used to protect the blade from hitting the ground.
- Reduce the risk of material wrapping around the blade by following these instructions:
 - 1 Always work at full throttle.
 - 2 Avoid the previously cut material during the return stroke.
- Stop the engine, unclip the harness and place the machine on the ground before you start to collect the cut material.

Grass trimming with a trimmer head



Trimming

- Hold the trimmer head just above the ground at an angle. It is the end of the cord that does the work. Let the cord work at its own pace. Never press the cord into the area to be cut.

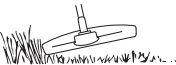

- The cord can easily remove grass and weeds up against walls, fences, trees and borders. However it can also damage sensitive bark on trees and bushes, and damage fence posts.

- Reduce the risk of damaging plants by shortening the cord to 10-12 cm and reducing the engine speed.

Clearing

- The clearing technique removes all unwanted vegetation. Keep the trimmer head just above the ground and tilt it. Let the end of the cord strike the ground around trees, posts, statues and the like. **CAUTION!** This technique increases the wear on the cord.



- The cord wears quicker and must be fed forward more often when working against stones, brick, concrete, metal fences, etc., than when coming into contact with trees and wooden fences.
- When trimming and clearing, you should use less than full throttle so that the cord lasts longer and to reduce the wear on the trimmer head.

Cutting

- The trimmer is ideal for cutting grass that is difficult to reach using a normal lawn mower. Keep the cord parallel to the ground when cutting. Avoid pressing the trimmer head against the ground as this can ruin the lawn and damage the tool.

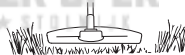

- Do not allow the trimmer head to constantly come into contact with the ground during normal cutting. Constant contact of this type can cause damage and wear to the trimmer head.

Sweeping

- The fan effect of the rotating cord can be used for quick and easy clearing up. Hold the cord parallel to and above the area to be swept and move the tool to and fro.

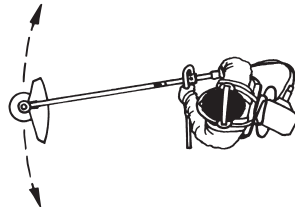

- When cutting and sweeping you should use full throttle to obtain the best results.

MAINTENANCE

Carburettor

Adjusting the idle speed (T)

Check that the air filter is clean. When the idle speed is correct, the cutting attachment should not rotate. If adjustment is required, close (turn clockwise) the idle adjustment screw T, with the engine running, until the cutting attachment starts to rotate. Open (turn anticlockwise) the screw until the cutting attachment stops. The idle speed is correctly set when the engine runs smoothly in all positions, and there is a clear margin to the speed at which the cutting attachment starts to rotate.

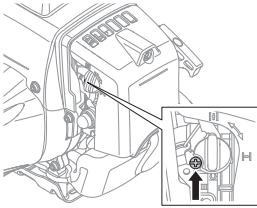

WARNING! If the idle speed cannot be adjusted so that the cutting attachment stops, contact your dealer/service workshop. Do not use the machine until it has been correctly adjusted or repaired.

Air filter



The air filter must be regularly cleaned to remove dust and dirt in order to avoid:

- Carburettor malfunctions
- Starting problems
- Loss of engine power
- Unnecessary wear to engine parts.
- Excessive fuel consumption.

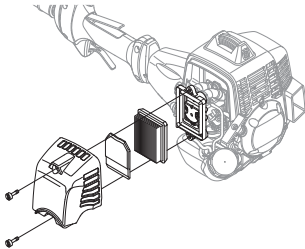

Clean the filter every 25 hours, or more regularly if conditions are exceptionally dusty.

Cleaning the air filter

Remove the air filter cover and take out the filter. Wash it clean in warm, soapy water. Ensure that the filter is dry before refitting it.

An air filter that has been in use for a long time cannot be cleaned completely. The filter must therefore be replaced with a new one at regular intervals. **A damaged air filter must always be replaced.**

Fuel filter

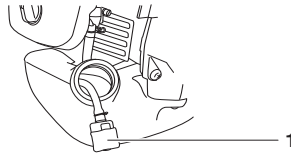

1 Fuel filter

When the engine runs short of fuel supply, check the fuel cap and the fuel filter for blockage.

Bevel gear



The bevel gear is filled with the right quantity of grease at the factory. However, before using the machine you should check that the bevel gear is filled three-quarters full with grease. Use HUSQVARNA special grease.

The grease in the bevel gear does not normally need to be changed except if repairs are carried out.

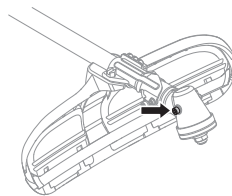

Spark plug



The spark plug condition is influenced by:

- Incorrect carburettor adjustment.
- An incorrect fuel mixture (too much or incorrect type of oil).
- A dirty air filter.

MAINTENANCE

These factors cause deposits on the spark plug electrodes, which may result in operating problems and starting difficulties.

If the machine is low on power, difficult to start or runs poorly at idle speed: always check the spark plug first before taking any further action. If the spark plug is dirty, clean it and check that the electrode gap is 0,6-0,7 mm. The spark plug should be replaced after about a month in operation or earlier if necessary.

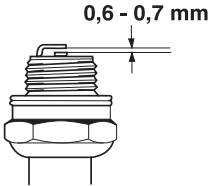

CAUTION! Always use the recommended spark plug type! Use of the wrong spark plug can damage the piston/cylinder. Check that the spark plug is fitted with a suppressor.

Drive shaft



The flexible drive axle is lubricated with Husqvarna drive axle grease. The axle must be lubricated at least every 6 months.

- Lift up the locking button that holds the drive shaft sleeve in the clutch cover.

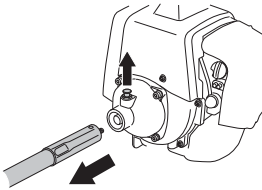

- Pull the drive shaft sleeve out of the clutch cover.
- Remove the drive shaft from the sleeve either by shaking it out or pulling it out using pliers.

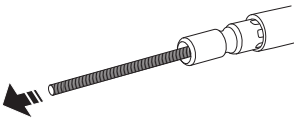

- Apply the grease from the tube along the whole axle. Spread with a brush or cloth.

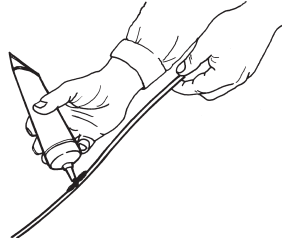

- Slide the drive shaft back into the sleeve. Make sure the shaft engages correctly by turning it and pushing at the same time.

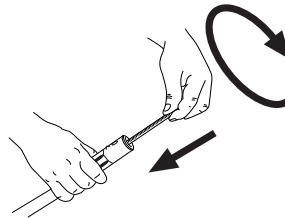

- When the shaft is correctly installed in the sleeve, the end of the shaft should project about 10 mm beyond the edge of the sleeve.

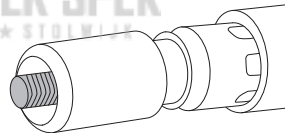

- Install the drive shaft sleeve in the clutch cover so that the hole is positioned directly underneath the locking button on the clutch cover.

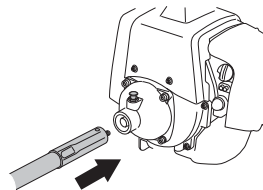

- Make sure the shaft engages correctly by turning it and pushing at the same time.

MAINTENANCE

Maintenance schedule

The following is a list of the maintenance steps that must be performed on the machine. Most of the items are described in the Maintenance section. The user must only carry out the maintenance and service work described in this Operator's Manual. More extensive work must be carried out by an authorized service workshop.

Maintenance	Daily maintenance	Weekly maintenance	Monthly maintenance
Clean the outside of the machine.	X		
Check that the harness is not damaged.	X		
Make sure the throttle trigger lock and the throttle function correctly from a safety point of view.	X		
Check that the handle and handlebar are undamaged and secured correctly.	X		
Check that the stop switch works correctly.	X		
Check that the cutting attachment does not rotate at idle.	X		
Clean the air filter. Replace if necessary.	X		
Check that the guard is undamaged and not cracked. Replace the guard if it has been exposed to impact or is cracked.	X		
Check that the blade is correctly centred, is sharp, and is not cracked. An off-centre blade will cause vibration that could result in damage to the machine.	X		
Check that the trimmer head is undamaged and not cracked. Replace the trimmer head if necessary.	X		
Check that the locking nut of the cutting equipment is tightened correctly.	X		
Check that the transport guard for the blade is intact and that it can be secured correctly.	X		
Check that nuts and screws are tight.	X		
Check that there are no fuel leaks from the engine, tank or fuel lines.	X		
Check the starter and starter cord.		X	
Check that the vibration damping elements are not damaged.		X	
Clean the outside of the spark plug. Remove it and check the electrode gap. Adjust the gap to 0,6-0,7 mm or replace the spark plug. Check that the spark plug is fitted with a suppressor.		X	
Clean the machine's cooling system.		X	
Clean the outside of the carburettor and the space around it.		X	
Check that the bevel gear is filled three-quarters full with lubricant. Fill if necessary using special grease.		X	
Clean the muffler.			X
Check the fuel filter from contamination and the fuel hose from cracks or other defects. Replace if necessary.			X
Check all cables and connections.			X
Check the clutch, clutch springs and the clutch drum for wear. Replace if necessary by an authorized service workshop.			X
Replace the spark plug. Check that the spark plug is fitted with a suppressor.			X
Lubricate the drive axle with Husqvarna drive axle grease.	Do this every six months.		

TECHNICAL DATA

Technical data

553RBX

Engine

Cylinder displacement, cm ³	50,6
Cylinder bore, mm	45,5
Stroke, mm	31,1
Idle speed, rpm	2800
Recommended max. speed, rpm	13000
Speed of output shaft, rpm	9285
Max. engine output, acc. to ISO 8893, kW/ rpm	2,3/9500
Catalytic converter muffler	No

Ignition system

Spark plug	NGK CMR7H
Electrode gap, mm	0,6-0,7

Fuel and lubrication system

Fuel tank capacity, litre	0.8
---------------------------	-----

Weight

Weight without fuel, cutting attachment and guard, kg	12,1
---	------

Noise emissions

(see note 1)

Sound power level, measured dB (A)	117
Sound power level, guaranteed L _{WA} dB (A)	118

Noise levels

(see note 2)

Equivalent sound pressure level at the operator's ear, measured according to EN ISO 11806 and ISO 22868, dB(A):

Equipped with trimmer head (original)	97
Equipped with grass blade (original)	97

Vibration levels

(see note 3)

Equivalent vibration levels ($a_{hv,eq}$) at handles, measured according to EN ISO 11806 and ISO 22867, m/s²

Equipped with trimmer head (original), left/right	2,7/3,3
Equipped with grass blade (original), left/right	2,7/3,8

Note 1: Noise emissions in the environment measured as sound power (L_{WA}) in conformity with EC directive 2000/14/EC. Reported sound power level for the machine has been measured with the original cutting attachment that gives the highest level. The difference between guaranteed and measured sound power is that the guaranteed sound power also includes dispersion in the measurement result and the variations between different machines of the same model according to Directive 2000/14/EC.

Note 2: Reported data for equivalent sound pressure level for the machine has a typical statistical dispersion (standard deviation) of 1 dB (A).

Note 3: Reported data for equivalent vibration level has a typical statistical dispersion (standard deviation) of 1 m/s².

TECHNICAL DATA

Approved accessories	Type	Cutting attachment guard, Art. no.
Grass blade/grass cutter	Multi 300-3 (Ø 300 3 teeth)	537 33 16-03
	Multi 275-4 (Ø 275 4 teeth)	537 33 16-03
Trimmer head	T45x (Ø 2.7 - 3.3 mm cord)	537 33 16-03
	T55x (Ø 2.7 - 3.3 mm cord)	537 33 16-03
Support cup	Fixed	-

EC-declaration of conformity (Applies to Europe only)

We, **Husqvarna AB**, SE-561 82 Huskvarna, Sweden, tel: +46-36-146500, declare that the brush cutters **Husqvarna 553RBX** with serial numbers dating from 2012 onwards (the year is clearly stated on the rating plate, followed by the serial number), comply with the requirements of the COUNCIL'S DIRECTIVE:

- of May 17, 2006 "relating to machinery" **2006/42/EC**

- of December 15, 2004 "relating to electromagnetic compatibility" **2004/108/EC**.

- of May 8, 2000 "relating to the noise emissions in the environment" **2000/14/EC**. Conformity assessment according to Annex V. For information relating to noise emissions, see the Technical data chapter.

The following standards have been applied: **EN ISO 12100:2010, CISPR 12:2007, ISO 14865:1998**.

SMP Svensk Maskinprovning AB, Fyrisborgsgatan 3, SE-754 50 Uppsala, Sweden, has carried out voluntary type approval for Husqvarna AB.

The certificate has the number: **SEC/12/2344**

Huskvarna February 8, 2012



Bengt Frögellius, Development manager (Authorized representative for Husqvarna AB and responsible for technical documentation.)

KFFS VAN DER SPEK

EXPLICATION DES SYMBOLES

Symboles

AVERTISSEMENT! Utilisés de manière négligente ou erronée, les débroussailluses et les coupe-herbes peuvent devenir des outils dangereux pouvant occasionner des blessures graves, voire mortelles pour l'utilisateur ou d'autres. Il est très important de lire attentivement et de bien comprendre les instructions contenues dans ce mode d'emploi.



Lire attentivement et bien assimiler le manuel d'utilisation avant d'utiliser la machine.



Toujours utiliser:

- Un casque de protection là où il y a risque de chute d'objets
- Protectors d'oreilles homologués
- Des protège-yeux homologués



Régime maxi. recommandé de l'axe sortant, tr/min



Ce produit est conforme aux directives CE en vigueur.



Attention: projections et ricochets.



L'utilisateur de la machine doit s'assurer qu'aucune personne ou animal ne s'approche à moins de 15 mètres pendant le travail.



Les machines équipées de lames d'éclaircissage ou de disques à herbe peuvent être projetées violemment d'un côté quand la lame heurte un objet fixe. Ce phénomène est appelé rebond. La lame peut amputer un bras ou une jambe. Veiller à ce que les personnes et les animaux soient toujours à au moins 15 mètres de la machine.



Flèches indiquant les limites quant à l'emplacement de la fixation de la poignée.



Allumage; starter: Mettre la commande de starter sur la position de starter. Le contacteur d'arrêt doit alors se placer automatiquement en position de démarrage.



Pompe à carburant.



Toujours porter des gants de protection homologués.



Utiliser des bottes antidérapantes et stables.



Destiné uniquement à des équipements de coupe flexibles et non métalliques, c'est-à-dire les têtes de désherbage avec fil.



Émissions sonores dans l'environnement selon la directive de la Communauté européenne. Les émissions de la machine sont indiquées au chapitre Caractéristiques techniques et sur les autocollants.



Maintenez toute partie du corps loin des surfaces chaudes.



Les autres symboles/autocollants présents sur la machine concernent des exigences de certification spécifiques à certains marchés.

Couper le moteur avant tout contrôle ou réparation en plaçant le bouton d'arrêt sur la position STOP.



Toujours porter des gants de protection homologués.



Un nettoyage régulier est indispensable.



Examen visuel.



SOMMAIRE

Sommaire

EXPLICATION DES SYMBOLES

Symboles 26

SOMMAIRE

Sommaire 27

Contrôler les points suivants avant la mise en marche: 27

INTRODUCTION

Cher client, 28

QUELS SONT LES COMPOSANTS?

Quels sont les composants de la débroussailleuse? 29

INSTRUCTIONS GÉNÉRALES DE SÉCURITÉ

Important! 30

Équipement de protection personnelle 30

Équipement de sécurité de la machine 31

Équipement de coupe 34

MONTAGE

Montage de l'arbre d'entraînement flexible 36

Connexion du câble de l'accélérateur et des fils du bouton d'arrêt 36

Montage de la poignée en J 36

Montage de la lame et de la tête de désherbage 37

Montage de la protection de transport 38

Adaptation du harnais et de la débroussailleuse 38

MANIPULATION DU CARBURANT

Sécurité carburant 40

Carburant 40

Remplissage de carburant 41

DÉMARRAGE ET ARRÊT

Contrôles avant la mise en marche 42

Démarrage et arrêt 42

TECHNIQUES DE TRAVAIL

Méthodes de travail 44

ENTRETIEN

Carburateur 47

Filtre à air 47

Filtre à carburant 47

Renvoi d'angle 47

Bougie 47

Arbre d'entraînement 48

Schéma d'entretien 49

CARACTÉRISTIQUES TECHNIQUES

Caractéristiques techniques 50

Assurance de conformité UE 51

Contrôler les points suivants avant la mise en marche:

Lire attentivement le manuel d'utilisation.



AVERTISSEMENT! Une exposition prolongée au bruit risque de causer des lésions auditives permanentes. Toujours utiliser des protecteurs d'oreille agréés.



AVERTISSEMENT! Ne jamais modifier sous aucun prétexte la machine sans l'autorisation du fabricant. N'utiliser que des accessoires et des pièces d'origine. Des modifications non-autorisées et l'emploi d'accessoires non-homologués peuvent provoquer des accidents graves et même mortels, à l'utilisateur ou d'autres personnes.



AVERTISSEMENT! Utilisés de manière négligente ou erronée, les débroussailleuses et les coupe-herbes peuvent devenir des outils dangereux pouvant occasionner des blessures graves, voire mortelles pour l'utilisateur ou d'autres. Il est très important de lire attentivement et de bien comprendre les instructions contenues dans ce mode d'emploi.

INTRODUCTION

Cher client,

Félicitations pour ce choix d'un produit Husqvarna. Husqvarna a vu le jour en 1689 lorsque le roi Karl XI décida de construire un arsenal pour la fabrication des mousquets au bord de la rivière Huskvarna. Le choix de l'emplacement était logique puisque la rivière Huskvarna servait à produire de l'énergie hydraulique et constituait donc une sorte de centrale hydraulique. En plus de 300 ans d'existence, l'usine Husqvarna a fabriqué de nombreux produits, depuis les cuisinières à bois jusqu'aux équipements de cuisine modernes, sans oublier les machines à coudre, les bicyclettes, les motos, etc. La première tondeuse à moteur a été lancée en 1956, suivie en 1959 de la première tronçonneuse. C'est dans ce secteur que Husqvarna est actif aujourd'hui.

Husqvarna est aujourd'hui un des plus grands fabricants du monde de produits destinés à l'entretien des forêts et des jardins. La qualité et les performances sont nos priorités. Notre concept d'affaires est de développer, fabriquer et commercialiser des produits à moteur pour l'entretien des forêts et des jardins et pour les entreprises de construction et d'aménagement des sols. L'objectif d'Husqvarna est aussi d'être à la pointe du progrès en matière d'ergonomie, de facilité d'utilisation, de sécurité et de protection de l'environnement; un grand nombre d'innovations ont été développées pour améliorer les produits dans ces domaines.

Nous sommes persuadés que vous apprécierez la qualité et les performances de nos produits pendant de longues années. L'achat d'un de nos produits vous garantit une assistance professionnelle au niveau du service et des réparations en cas de besoin. Si la machine n'a pas été achetée chez un de nos revendeurs autorisés, demandez à un revendeur l'adresse de l'atelier d'entretien le plus proche.

Nous espérons que cette machine vous donnera toute satisfaction et qu'elle vous accompagnera pendant de longues années. N'oubliez pas que ce manuel d'utilisation est important. En suivant les instructions qu'il contient (utilisation, révision, entretien, etc.), il est possible d'allonger considérablement la durée de vie de la machine et d'augmenter sa valeur sur le marché de l'occasion. En cas de vente de la machine, ne pas oublier de remettre le manuel d'utilisation au nouveau propriétaire.

Nous vous remercions d'utiliser un produit Husqvarna !

Husqvarna AB travaille continuellement au développement de ses produits et se réserve le droit d'en modifier, entre autres, la conception et l'aspect sans préavis.

KEES VAN DER SPEK
TUINMACHINES ★ STOLWIJK

QUELS SONT LES COMPOSANTS?

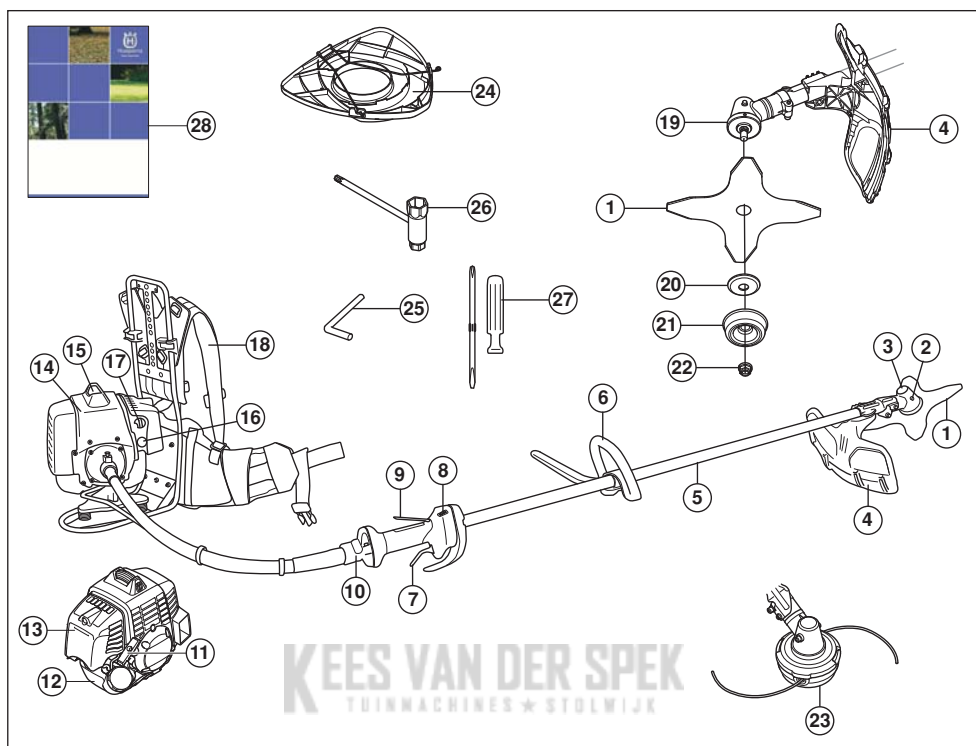

Quels sont les composants de la débroussailleuse?

- | | | | |
|----|--|----|--|
| 1 | Lame | 15 | Chapeau de bougie et bougie |
| 2 | Ravitaillement en lubrifiant, renvoi d'angle | 16 | Pompe à carburant. |
| 3 | Renvoi d'angle | 17 | Commande de starter |
| 4 | Protection pour l'équipement de coupe | 18 | Harnais |
| 5 | Tube de transmission | 19 | Toc d'entraînement |
| 6 | Poignée anneau | 20 | Bride de support |
| 7 | Commande de l'accélération | 21 | Bol de garde au sol |
| 8 | Bouton d'arrêt | 22 | Contre-écrou |
| 9 | Blocage de l'accélération | 23 | Tête de désherbage |
| 10 | Raccord du tube de transmission | 24 | Dispositif de protection pour le transport |
| 11 | Poignée de lanceur | 25 | Goupille d'arrêt |
| 12 | Réservoir d'essence | 26 | Clé pour l'écrou de lame |
| 13 | Carter de filtre à air | 27 | Tournevis |
| 14 | Capot de cylindre | 28 | Manuel d'utilisation |

INSTRUCTIONS GÉNÉRALES DE SÉCURITÉ

Important!

IMPORTANT!

La machine est conçue uniquement pour le désherbage et le débroussaillage.

Les seuls accessoires pouvant utiliser le moteur comme source motrice sont les équipements de coupe que nous recommandons au chapitre Caractéristiques techniques.

Éviter d'utiliser la machine en cas de fatigue, d'absorption d'alcool ou de prise de médicaments susceptibles d'affecter l'acuité visuelle, le jugement ou la maîtrise du corps.

Utiliser les équipements de protection personnelle. Voir au chapitre "Équipement de protection personnelle".

Ne jamais utiliser une machine qui a été modifiée au point de ne plus être conforme au modèle original.

Ne jamais utiliser une machine qui n'est pas en parfait état de marche. Suivre dans ce manuel d'utilisation les instructions de maintenance, de contrôle et d'entretien. Certaines mesures de maintenance et d'entretien doivent être confiées à un spécialiste dûment formé et qualifié. Voir au chapitre Entretien.

Tous les capots, toutes les protections et toutes les poignées doivent avoir été montées avant d'utiliser la machine. Vérifier que le capuchon de la bougie et le câble d'allumage sont en bon état afin d'éliminer tout risque de choc électrique.

L'utilisateur de la machine doit s'assurer qu'aucune personne ou animal ne s'approche à moins de 15 mètres pendant le travail. Lorsque plusieurs utilisateurs travaillent dans une même zone, il convient d'observer une distance de sécurité égale au moins au double de la longueur de l'arbre, mais jamais moins de 15 mètres.



AVERTISSEMENT! Cette machine génère un champ électromagnétique en fonctionnement. Ce champ peut dans certaines circonstances perturber le fonctionnement d'implants médicaux actifs ou passifs. Pour réduire le risque de blessures graves ou mortelles, les personnes portant des implants médicaux doivent consulter leur médecin et le fabricant de leur implant avant d'utiliser cette machine.



AVERTISSEMENT! Faire tourner un moteur dans un local fermé ou mal aéré peut causer la mort par asphyxie ou empoisonnement au monoxyde de carbone.



AVERTISSEMENT! Ne jamais laisser des enfants utiliser la machine ou se tenir à proximité. La machine est équipée d'un interrupteur d'arrêt à détente et peut être démarrée par une activation à faible vitesse et de faible puissance de la poignée de démarrage ; dans certaines circonstances, de jeunes enfants peuvent produire la force nécessaire au démarrage de la machine. Ceci peut entraîner un risque de blessures personnelles. Retirer donc le chapeau de bougie lorsque la machine n'est pas sous surveillance.

Équipement de protection personnelle

IMPORTANT!

Utilisés de manière négligente ou erronée, les débroussailleuses et les coupe-herbes peuvent devenir des outils dangereux pouvant occasionner des blessures graves, voire mortelles pour l'utilisateur ou d'autres. Il est très important de lire attentivement et de bien comprendre les instructions contenues dans ce mode d'emploi.

Un équipement de protection personnelle homologué doit impérativement être utilisé lors de tout travail avec la machine. L'équipement de protection personnelle n'élimine pas les risques mais réduit la gravité des blessures en cas d'accident. Demander conseil au concessionnaire afin de choisir un équipement adéquat.



AVERTISSEMENT! Soyez toujours attentifs aux signaux d'alerte ou aux appels en portant des protège-oreilles. Enlevez-les sitôt le moteur arrêté.

CASQUE

Un casque de protection là où il y a risque de chute d'objets

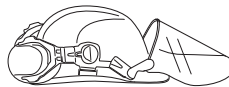

PROTÈGE-OREILLES

Porter des protège-oreilles ayant un effet atténuateur suffisant.



INSTRUCTIONS GÉNÉRALES DE SÉCURITÉ

PROTÈGE-YEUX

Toujours porter des protège-yeux homologués. L'usage d'une visière doit toujours s'accompagner du port de lunettes de protection homologuées. Par lunettes de protection homologuées, on entend celles qui sont en conformité avec les normes ANSI Z87.1 (États-Unis) ou EN 166 (pays de l'UE).

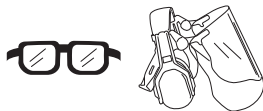

GANTS

Au besoin, utiliser des gants, notamment lors du montage de l'équipement de coupe.



BOTTES

Utiliser des bottes antidérapantes et stables.



HABITS

Porter des vêtements fabriqués dans un matériau résistant à la déchirure, éviter les vêtements excessivement amples qui risqueraient de se prendre dans les broussailles et les branches. Toujours utiliser des pantalons longs et robustes. Ne pas porter de bijoux, de shorts ou de sandales, et ne pas marcher pieds-nus. Veiller à ce que les cheveux ne tombent pas sur les épaules.

PREMIERS SECOURS

Une trousse de premiers secours doit toujours être disponible.



Équipement de sécurité de la machine

Ce chapitre présente les équipements de sécurité de la machine, leur fonction, comment les utiliser et les maintenir en bon état. Voir au chapitre Quels sont les composants? pour trouver leur emplacement sur la machine.

La durée de vie de la machine risque d'être écourtée et le risque d'accidents accru si la maintenance de la machine

n'est pas effectuée correctement et si les mesures d'entretien et/ou de réparation ne sont pas effectuées de manière professionnelle. Pour obtenir de plus amples informations, contacter l'atelier de réparation le plus proche.

IMPORTANT! L'entretien et la réparation de la machine exigent une formation spéciale. Ceci concerne particulièrement l'équipement de sécurité de la machine. Si les contrôles suivants ne donnent pas un résultat positif, s'adresser à un atelier spécialisé. L'achat de l'un de nos produits offre à l'acheteur la garantie d'un service et de réparations qualifiés. Si le point de vente n'assure pas ce service, s'adresser à l'atelier spécialisé le plus proche.



AVERTISSEMENT! Ne jamais utiliser une machine dont les équipements de sécurité sont défectueux. Contrôler et entretenir les équipements de sécurité de la machine conformément aux instructions données dans ce chapitre. Si les contrôles ne donnent pas de résultat positif, confier la machine à un atelier spécialisé.

Blocage de l'accélération

Le blocage de l'accélération a pour but d'empêcher toute accélération involontaire. Une fois le cliquet (A) enfoncé dans la poignée (= en tenant celle-ci), la commande de l'accélération (B) se trouve libérée. Quand la poignée est relâchée, la commande de l'accélération et le cliquet reviennent en position initiale. Ce retour en position initiale s'effectue grâce à deux ressorts de rappel indépendants. Cette position signifie que la commande d'accélération est alors automatiquement bloquée sur le ralenti.

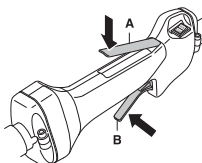

Vérifier d'abord que la commande de l'accélération est bloquée en position de ralenti quand le blocage de l'accélération est en position initiale.

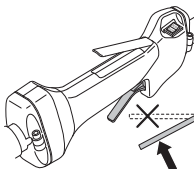

INSTRUCTIONS GÉNÉRALES DE SÉCURITÉ

Appuyer sur le blocage de l'accélération et vérifier qu'il revient de lui-même en position initiale quand il est relâché.

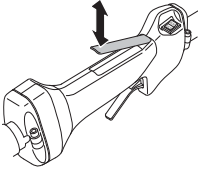

Vérifier que le blocage de l'accélération, la commande d'accélération et leurs ressorts de rappel fonctionnent correctement.

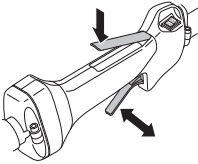

Voir le chapitre Démarrage. Démarrer la machine et donner les pleins gaz. Relâcher l'accélérateur et s'assurer que l'équipement de coupe s'arrête et qu'il reste immobile. Si l'équipement de coupe tourne lorsque l'accélérateur est au régime de ralenti, contrôler le réglage du ralenti du carburateur. Voir le chapitre Entretien.

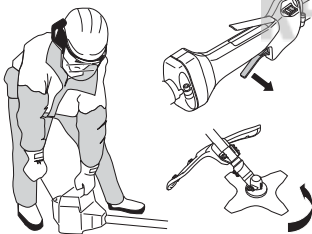

Bouton d'arrêt

Le bouton d'arrêt est utilisé pour arrêter le moteur.

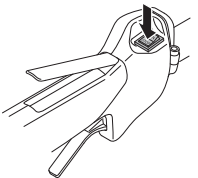

Mettre le moteur en marche et s'assurer qu'il s'arrête lorsque le bouton d'arrêt est amené en position d'arrêt.

Protection pour l'équipement de coupe

Cette protection a pour but d'empêcher que des objets ne soient projetés en direction de l'utilisateur. La protection prévient aussi le contact entre l'utilisateur et l'équipement de coupe.

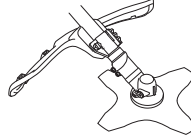

S'assurer que la protection est intacte et qu'elle ne présente pas de fissures. Remplacer la protection si elle a subi des coups ou si elle présente des fissures.

Toujours utiliser la protection recommandée prévue pour l'équipement de coupe en question. Voir Caractéristiques techniques.



AVERTISSEMENT! Un équipement de coupe ne peut en aucun cas être utilisé si une protection homologuée n'a pas été préalablement montée. Voir le chapitre Caractéristiques techniques. La mise en place d'une protection erronée ou défectueuse peut provoquer des blessures graves.

Système anti-vibrations

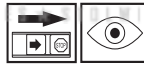

La machine est équipée d'un système anti-vibrations conçu pour assurer une utilisation aussi confortable que possible.

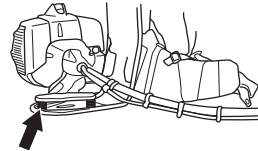

L'utilisation d'un fil mal enroulé ou d'un équipement de coupe mal affûté, défectueux (équipement non adapté ou mal affûté, voir le chapitre Affûtage de la lame) augmente le niveau des vibrations.

Le système anti-vibrations réduit la transmission des vibrations de l'unité moteur/l'équipement de coupe à l'unité que constituent les poignées.

Vérifier régulièrement l'état des éléments afin de détecter fissures et déformations. Vérifier que les éléments anti-vibrations sont entiers et solidement fixés.

INSTRUCTIONS GÉNÉRALES DE SÉCURITÉ



AVERTISSEMENT! Une exposition excessive aux vibrations peut entraîner des troubles circulatoires ou nerveux chez les personnes sujettes à des troubles cardio-vasculaires. Consulter un médecin en cas de symptômes liés à une exposition excessive aux vibrations. De tels symptômes peuvent être: engourdissement, perte de sensibilité, chatouillements, picotements, douleur, faiblesse musculaire, décoloration ou modification épidermique. Ces symptômes affectent généralement les doigts, les mains ou les poignets. Les risques peuvent augmenter à basses températures.

Silencieux

Le silencieux est conçu pour réduire au maximum le niveau sonore et détourner les gaz d'échappement loin de l'utilisateur. Le silencieux équipé d'un pot catalytique est aussi conçu pour réduire la teneur des gaz d'échappement en substances toxiques.

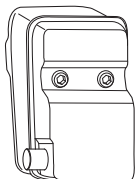

Ne jamais utiliser une machine dont le silencieux est défectueux.

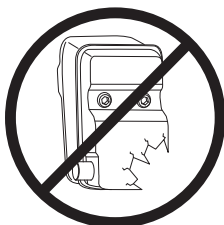

Vérifier régulièrement la fixation du silencieux dans la machine.

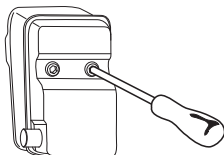

Si le silencieux comporte une grille antiflamme, la nettoyer régulièrement. Une grille colmatée résulte en un échauffement du moteur pouvant donner lieu à de graves avaries du moteur.



AVERTISSEMENT! Un silencieux muni d'un catalyseur est très chaud aussi bien à l'utilisation qu'après arrêt. Ceci est également vrai pour le régime au ralenti. Tout contact peut causer des brûlures à la peau. Attention au risque d'incendie!



AVERTISSEMENT! L'intérieur du silencieux contient des produits chimiques pouvant être cancérigènes. Éviter tout contact avec ces éléments si le silencieux est endommagé.



AVERTISSEMENT! N'oubliez pas que: Les gaz d'échappement du moteur sont très chauds et peuvent contenir des étincelles pouvant provoquer un incendie. Par conséquent, ne jamais démarrer la machine dans un local clos ou à proximité de matériaux inflammables!

Contre-écrou

Un contre-écrou est utilisé pour la fixation de certains types d'équipements de coupe.



Pose: serrer l'écrou dans le sens contraire de la rotation de l'équipement de coupe. Dépose: desserrer l'écrou dans le sens de la rotation de l'équipement de coupe. (NOTA! L'écrou est fileté à gauche.) Serrer l'écrou à l'aide de la clé pour l'écrou de lame.

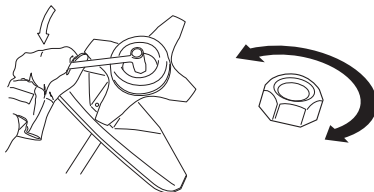

L'usure du verrouillage nylon du contre-écrou ne doit pas être telle qu'il peut se visser à l'aide des doigts. Le verrouillage doit résister à 1,5 Nm au moins. Remplacer le contre-écrou après une dizaine de serrages.

INSTRUCTIONS GÉNÉRALES DE SÉCURITÉ

Harnais



Vérifier que le harnais est intact.

En cas d'urgence, dégagez-vous de la machine et du harnais en suivant la procédure suivante.

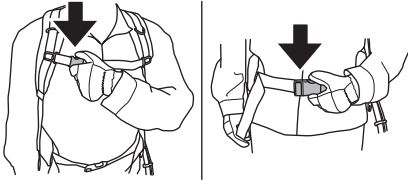

Équipement de coupe

Cette section explique comment, grâce à l'utilisation du bon équipement de coupe et grâce à un entretien correct:

- Réduire le risque de rebond de la machine.
- Obtenir la meilleure coupe possible.
- Augmenter la durée de vie de l'équipement de coupe.

IMPORTANT!

N'utiliser l'équipement de coupe qu'avec la protection recommandée! Voir le chapitre Caractéristiques techniques.

Voir les instructions relatives à l'équipement de coupe pour poser correctement le fil et choisir le diamètre de fil approprié.

Maintenir les dents de la lame correctement affûtées! Suivre nos recommandations. Voir aussi les instructions sur l'emballage des lames.



AVERTISSEMENT! Toujours arrêter le moteur avant d'entamer des travaux sur l'équipement de coupe. Celui-ci continue de tourner après qu'on a relâché l'accélérateur. S'assurer que l'équipement de coupe est complètement immobilisé et débrancher le câble de la bougie d'allumage avant de commencer l'intervention sur l'équipement de coupe.



AVERTISSEMENT! Un équipement de coupe inadéquat ou une lame mal affûtée augmentent les risques de rebond.

Équipement de coupe

Les lames et couteau à herbe sont destinés à la coupe de l'herbe épaisse.

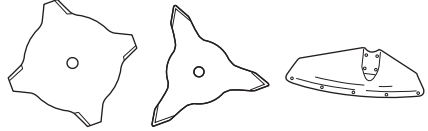

La tête de désherbage est destinée au désherbage.



Règles élémentaires



N'utiliser l'équipement de coupe qu'avec la protection recommandée! Voir le chapitre Caractéristiques techniques.

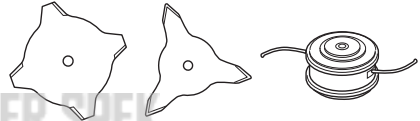

Maintenir les dents de la lame correctement affûtées! Suivre nos instructions et utiliser le calibre d'affûtage recommandé. Une lame mal affûtée ou endommagée augmente les risques d'accident.

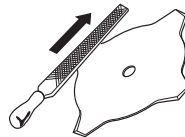

Inspecter l'équipement de coupe afin de détecter d'éventuels dommages ou fissures. Toujours remplacer un équipement de coupe endommagé.

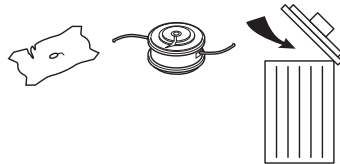

INSTRUCTIONS GÉNÉRALES DE SÉCURITÉ

Affûtage des lames et couteaux à herbe



- Voir les instructions d'affûtage sur l'emballage de l'équipement de coupe. Les lames et couteaux s'affûtent à l'aide d'une lime plate à taille simple.
- Limer les tranchants de manière égale afin de préserver l'équilibre.

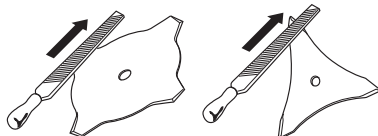

AVERTISSEMENT! Toujours jeter une lame pliée, faussée, fissurée, cassée ou abîmée de toute autre façon. Ne jamais essayer de redresser une lame faussée pour l'utiliser de nouveau. Utiliser uniquement des lames d'origine du modèle recommandé.

Tête de désherbage

IMPORTANT!

Veiller à ce que le fil du coupe-herbe soit toujours enroulé de manière serrée et régulière autour du tambour, autrement la machine produit des vibrations dangereuses pour la santé.

- N'utiliser que les têtes de désherbage et les fils recommandés. Ils ont été testés par le fabricant pour aller de pair avec une certaine puissance de moteur. Ceci est d'autant plus important lors de l'utilisation d'une tête de désherbage entièrement automatique. N'utiliser que l'équipement de coupe recommandé. Voir le chapitre Caractéristiques techniques.



- En général, les petites machines demandent des petites têtes de désherbage, et vice versa. Cela vient du fait que lors du désherbage au moyen de fils, le moteur doit éjecter le fil radialement depuis la tête de désherbage tout en affrontant la résistance de l'herbe à couper.
- La longueur du fil est également importante. Un fil long demande un moteur plus puissant qu'un fil court, même en cas de diamètre égal de fil.
- S'assurer que le couteau monté sur le carter de protection est intact. Il sert à découper le fil à la bonne longueur.

- Pour améliorer la durée de vie du fil, laisser le fil tremper dans de l'eau pendant quelques nuits. Le fil devient alors plus résistant et dure plus longtemps.

MONTAGE

Montage de l'arbre d'entraînement flexible



- Desserrez deux vis sur le raccord du tube de transmission.

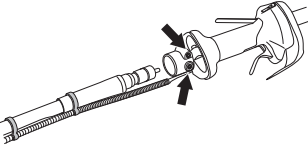

- Faites glisser l'arbre flexible dans les boucles du câblage et fixez l'arbre flexible sur le raccord du tube de transmission. Assurez-vous que l'arbre s'engage correctement en le tournant et le poussant en même temps.
- Serrer les deux vis.
- Monter la gaine de l'arbre d'entraînement dans le carter d'embrayage de sorte que le trou se place juste en dessous du bouton de verrouillage sur le carter d'embrayage.

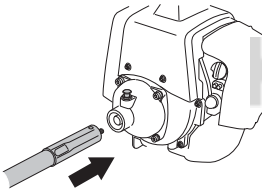

- Assurez-vous que l'arbre s'engage correctement en le tournant et le poussant en même temps.
- Assurez-vous que la goupille de blocage retourne à sa position initiale, de façon à ce que le manchon de l'arbre d'entraînement ne puisse pas se détacher du boîtier de l'embrayage.

Connexion du câble de l'accélérateur et des fils du bouton d'arrêt



- Placez le câble d'accélération du câblage (A) et le câble d'accélération du moteur (B) dans le manchon en plastique comme indiqué sur la figure.

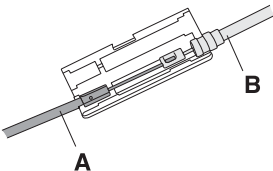

- Fermez le manchon en plastique.
- Brancher les fils du bouton d'arrêt sur les connecteurs correspondants du moteur. La polarité des fils est importante.

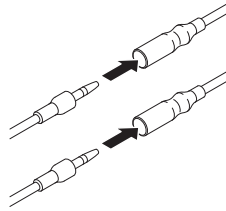

Montage de la poignée en J



- Placer la poignée contre le tube de transmission. Noter que la poignée doit être montée en dessous du marquage fléché situé sur le tube de transmission.

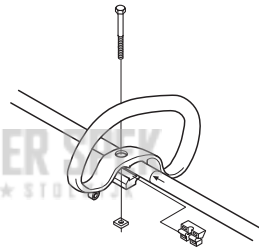

- Introduire l'entretoise dans la rainure de la poignée anneau.
- Monter l'écrou et la vis. Ne pas serrer trop fort.
- La poignée en J doit être montée dans la poignée anneau à l'aide de trois vis comme indiqué sur la figure.

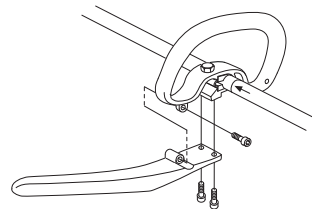

MONTAGE

- Effectuer un réglage de précision afin de tenir le coupe-herbe dans une position de travail confortable. Serrer la vis/la manette.

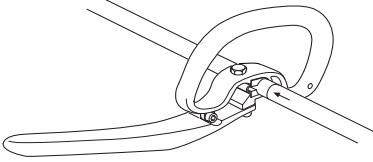

AVERTISSEMENT! Lors du montage de la poignée en J, utiliser uniquement des lames/couteaux à herbe ou une tête de désherbage/des couteaux en plastique. Ne jamais utiliser la lame d'éclaircissage avec la poignée en J.

Montage de la lame et de la tête de désherbage



AVERTISSEMENT! Lors du montage de l'équipement de coupe, il est de la plus grande importance que la commande du bras d'entraînement/de la bride de renfort soit positionnée correctement dans l'ouverture centrale de l'équipement de coupe. Un équipement de coupe mal monté peut causer des blessures personnelles très graves, voire mortelles.

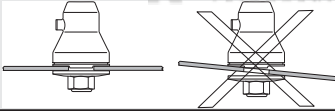

AVERTISSEMENT! Un équipement de coupe ne peut en aucun cas être utilisé si une protection homologuée n'a pas été préalablement montée. Voir le chapitre Caractéristiques techniques. La mise en place d'une protection erronée ou défectueuse peut provoquer des blessures graves.

IMPORTANT! L'utilisation d'une lame d'éclaircissage ou à herbe exige que la machine soit équipée d'un guidon approprié, d'un protège-lame et d'un harnais.

Montage du bouclier de protection



REMARQUE! Le bouclier de protection doit toujours être en place lors d'utilisation de la tête de désherbage/des couteaux en plastique et de la protection combinée. Lorsque une lame à herbe et la protection combinée sont utilisées, le bouclier de protection doit toujours être déposé.

Emboîter le protège-lame/la protection combinée (A) dans la fixation du tube de transmission et fixer à l'aide d'une vis.

Insérer la rainure de guidage du bouclier de protection dans la gorge de la protection combinée. Accrocher ensuite le bouclier à la protection combinée à l'aide des quatre fixations rapides.

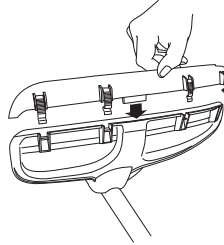

Le bouclier de protection s'enlève facilement à l'aide d'un tournevis, voir la figure.

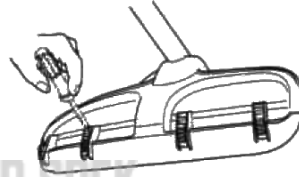

Montage du protège-lame, de la lame à herbe et du couteau à herbe



- Emboîter le protège-lame/la protection combinée (A) dans la fixation du tube de transmission et fixer à l'aide d'une vis (L). Utiliser le protège-lame recommandé. Voir le chapitre Caractéristiques techniques. **REMARQUE!** Veiller à ce que le bouclier de protection soit démonté.

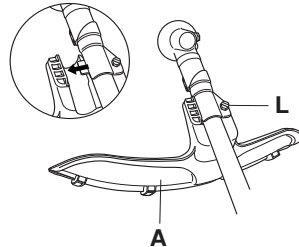

- Monter un toc d'entraînement (B) sur l'axe sortant.
- Faire tourner l'axe de la lame jusqu'à ce que l'un des trous du toc d'entraînement coïncide avec le trou correspondant du carter.
- Insérer la goupille d'arrêt (C) dans le trou afin de bloquer l'axe.
- Placer la lame (D), le bol de garde au sol (E) et la bride de support (F) sur l'axe sortant.

MONTAGE

- Monter l'écrou (G). Serrer l'écrou au couple de serrage de 35-50 Nm (3,5-5 kpm). Utiliser la clé à douille du jeu d'outils. Tenir le manche de la clé le plus près possible du protège-lame. Serrer l'écrou en tournant la clé dans le sens de rotation (NB! filetage à gauche).

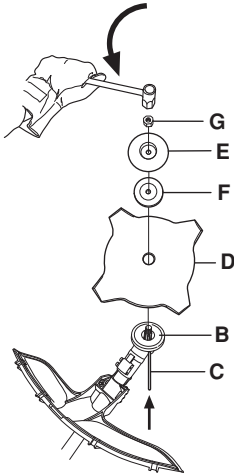

Montage de la protection de la tête et de la tête de désherbage



- Monter le carter de protection (A) destiné au travail avec la tête de désherbage. REMARQUE! Veiller à ce que le bouclier de protection soit monté.

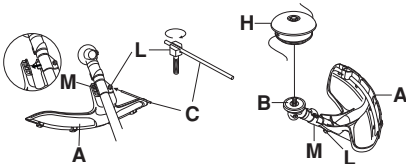

- Emboîter le carter de protection/la protection combinée dans la fixation du tube de transmission et fixer à l'aide d'une vis (L).
- Monter un toc d'entraînement (B) sur l'axe sortant.
- Faire tourner l'axe de la lame jusqu'à ce que l'un des trous du toc d'entraînement coïncide avec le trou correspondant du carter.
- Insérer la goupille d'arrêt (C) dans le trou afin de bloquer l'axe.

- Visser la tête de désherbage/les couteaux en plastique (H) dans le sens contraire de la rotation.

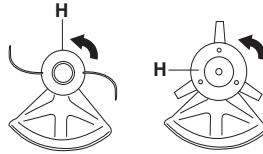

- Le démontage s'effectue dans l'ordre inverse.

Montage de la protection de transport



- Insérer la lame dans la protection de transport (A).
- Introduire les deux fixations (B) dans les rainures (C) pour sécuriser la protection de transport.

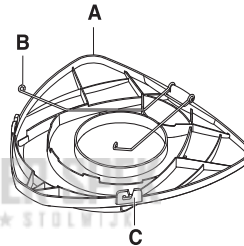

Adaptation du harnais et de la débroussailleuse



Réglage de la hauteur de la platine arrière

- Desserrez les deux fixations qui maintiennent la platine arrière.

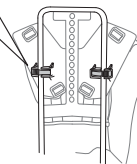
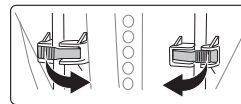

MONTAGE

- Desserrez la platine arrière du cadre d'un côté.

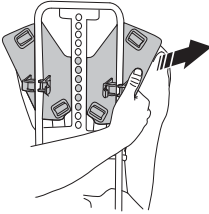

- Réglez la platine arrière à la hauteur désirée et fixez-la. Assurez-vous que la goupille soit alignée avec l'un des trous sur le cadre, voir figure.

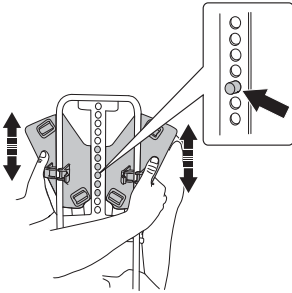

Réglage du harnais

- Enfiler le harnais.
- Serrez la ceinture afin qu'elle soit bien stable.



- Serrez la sangle de poitrine.



- Réglez verticalement la sangle de poitrine si nécessaire, et assurez-vous qu'elle s'ajuste bien.

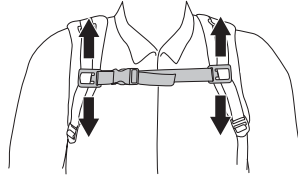

- Réglez les bretelles de manière à obtenir une répartition égale de la charge sur les épaules.



- Desserrez ou serrez la ceinture de façon à avoir environ 70 % de la charge sur votre taille et 30 % sur vos épaules.

KEES VAN DER SPEK
TUINMACHINES * STOLWIJK

MANIPULATION DU CARBURANT

Sécurité carburant

Ne jamais démarrer la machine:

- 1 Si du carburant a été renversé. Essuyer soigneusement toute trace et laisser les restes d'essence s'évaporer.
- 2 Si vous avez renversé du carburant sur vous ou sur vos vêtements, changez de vêtements. Lavez les parties du corps qui ont été en contact avec le carburant. Utilisez de l'eau et du savon.
- 3 S'il y a fuite de carburant. Vérifier régulièrement que le bouchon du réservoir et la conduite de carburant ne fuient pas.

Transport et rangement

- Transporter et ranger la machine et le carburant de façon à éviter que toute fuite ou émanation éventuelle entre en contact avec une flamme vive ou une étincelle: machine électrique, moteur électrique, contact/interrupteur électrique ou chaudière.
- Lors du stockage et du transport de carburant, toujours utiliser un récipient homologué et conçu à cet effet.
- Lors des remisages de la machine, vider le réservoir de carburant. S'informer auprès d'une station-service comment se débarrasser du carburant résiduel.
- Avant de remiser la machine pour une période prolongée, veiller à ce qu'elle soit bien nettoyée et que toutes les mesures d'entretien aient été effectuées.
- Lors du stockage et du transport de la machine, toujours utiliser la protection de transport de l'équipement de coupe.
- Sécurisez la machine pendant le transport.



AVERTISSEMENT! Manipuler le carburant avec précaution. Penser aux risques d'incendie, d'explosion et d'inhalation.

Carburant

REMARQUE! La machine est équipée d'un moteur deux temps et doit toujours être alimentée avec un mélange d'essence et d'huile deux temps. Afin d'obtenir un mélange approprié, il est important de mesurer avec précision la quantité d'huile à mélanger. Pour le mélange de petites quantités de carburant, la moindre erreur peut sérieusement affecter le rapport du mélange.



AVERTISSEMENT! Le carburant et les vapeurs de carburant sont très inflammables et peuvent causer des blessures graves en cas d'inhalation ou de contact avec la peau. Il convient donc d'observer la plus grande prudence lors de la manipulation du carburant et de veiller à disposer d'une bonne aération.

Essence



REMARQUE! Toujours utiliser une essence de qualité d'au moins 90 octanes (RON) mélangée avec de l'huile. Si la machine est équipée d'un pot catalytique (voir Caractéristiques techniques), n'utiliser que de l'essence sans plomb de qualité mélangée à de l'huile. Une essence au plomb détruirait le pot catalytique.

Choisissez de l'essence écologique (alkylat) si vous pouvez vous en procurer.



- Le taux d'octane minimum recommandé est de 90 (RON). Si l'on fait tourner le moteur avec une essence d'un taux d'octane inférieur à 90, un cognement risque de se produire, résultant en une augmentation de la température du moteur pouvant causer de graves avaries du moteur.
- Si on travaille en permanence à des régimes élevés, il est conseillé d'utiliser un carburant d'un indice d'octane supérieur.

Huile deux temps

- Pour obtenir un fonctionnement et des résultats optimaux, utiliser une huile moteur deux temps HUSQVARNA fabriquée spécialement pour nos moteurs deux temps à refroidissement à air.
- Ne jamais utiliser d'huile deux temps pour moteurs hors-bord refroidis par eau, appelée huile outboard (désignation TCW).
- Ne jamais utiliser d'huile pour moteurs à quatre temps.
- Une huile de qualité médiocre ou un mélange huile/carburant trop riche risquent de mettre en péril le fonctionnement du pot catalytique et d'en réduire la durée de vie.
- Rapport de mélange
1:50 (2%) avec huile deux temps HUSQVARNA.
1:33 (3%) avec d'autres huiles conçues pour des moteurs deux temps à refroidissement par air classés pour JASO FB/ISO EGB.

Essence, litres	Huile deux temps, litres	
	2% (1:50)	3% (1:33)
5	0,10	0,15
10	0,20	0,30
15	0,30	0,45
20	0,40	0,60

MANIPULATION DU CARBURANT

Mélange

- Toujours effectuer le mélange dans un récipient propre et destiné à contenir de l'essence.
- Toujours commencer par verser la moitié de l'essence à mélanger. Verser ensuite la totalité de l'huile. Mélanger en secouant le récipient. Enfin, verser le reste de l'essence.
- Mélanger (secouer) soigneusement le mélange avant de faire le plein du réservoir de la machine.

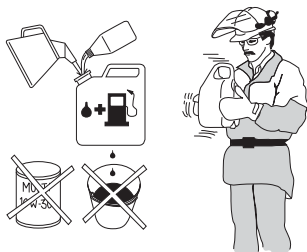

- Ne jamais préparer plus d'un mois de consommation de carburant à l'avance.
- Si la machine n'est pas utilisée pendant une longue période, vidanger et nettoyer le réservoir.



AVERTISSEMENT! Le pot d'échappement à catalyseur est très chaud pendant et après le service. C'est également vrai pour le ralenti. Soyez attentif au risque d'incendie, surtout à proximité de produits inflammables et/ou en présence de gaz.

Remplissage de carburant



AVERTISSEMENT! Les mesures de sécurité ci-dessous réduisent le risque d'incendie:

Ne jamais fumer ni placer d'objet chaud à proximité du carburant.

Ne jamais faire le plein, moteur en marche.

Arrêter le moteur et le laisser refroidir pendant quelques minutes avant de faire le plein.

Ouvrir le bouchon du réservoir lentement pour laisser baisser la surpression pouvant régner dans le réservoir.

Serrer soigneusement le bouchon du réservoir après le remplissage.

Éloignez toujours la machine de la zone et de la source du plein en carburant avant de la mettre en marche.

- Utiliser un bidon d'essence comportant un dispositif d'arrêt de remplissage automatique.
- Nettoyer le pourtour du bouchon de réservoir. Les impuretés dans le réservoir causent des troubles de fonctionnement.
- Bien mélanger le carburant en agitant le récipient avant de remplir le réservoir.

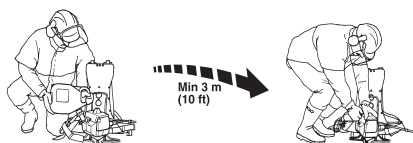

DÉMARRAGE ET ARRÊT

Contrôles avant la mise en marche



- Ne jamais utiliser la machine sans protection ou avec une protection défectueuse.
- Tous les carters doivent être correctement montés et sans défaut avant le démarrage de la machine.
- Contrôler la lame afin de détecter d'éventuelles fissures au niveau des dents et du trou central. Les raisons les plus fréquentes de la présence de fissures sont la formation de coins pointus lors de l'affûtage et l'utilisation d'une lame aux dents émoussées. Si des fissures sont constatées, mettre la lame au rebut.

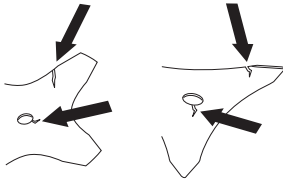

- S'assurer que la bride de support ne présente pas de fissures par suite d'usure ou de serrage trop fort. En cas de fissures, mettre la bride de support au rebut.

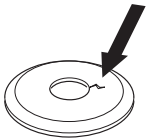

- S'assurer que le contre-écrou n'a pas perdu son pouvoir bloquant. Le contre-écrou doit résister à au moins 1,5 Nm. Le couple de serrage du contre-écrou doit être de 35-50 Nm.



- Contrôler le protège-lame afin de détecter d'éventuels dommages ou fissures. Remplacer le protège-lame s'il a subi des dommages ou s'il présente des fissures.

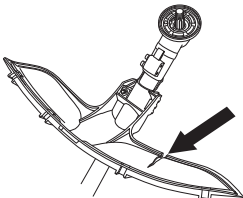

- Contrôler la tête de désherbage et le carter de protection afin de détecter d'éventuels dommages ou fissures. Remplacer la tête de désherbage ou le

carter de protection si l'un ou l'autre a subi des dommages ou présente des fissures.

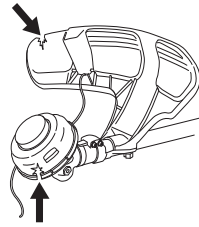

Démarrage et arrêt



AVERTISSEMENT! Un carter d'embrayage complet avec tube de transmission doit être monté avant de démarrer la machine, sinon l'embrayage risque de lâcher et de provoquer des blessures.

Éloignez toujours la machine de la zone et de la source du plein en carburant avant de la mettre en marche. Placer la machine sur une surface plane. S'assurer que l'équipement de coupe ne risque pas de rencontrer un obstacle.

Veiller à ce qu'aucune personne non autorisée ne se trouve dans la zone de travail pour éviter le risque de blessures graves. Distance de sécurité: 15 mètres.

Démarrage



Allumage: Mettre le contacteur d'arrêt en position de démarrage.

Pompe à carburant: Appuyer sur la poche en caoutchouc de la pompe à carburant plusieurs fois

DÉMARRAGE ET ARRÊT

jusqu'à ce que le carburant commence à remplir la poche. Il n'est pas nécessaire de remplir la poche complètement.

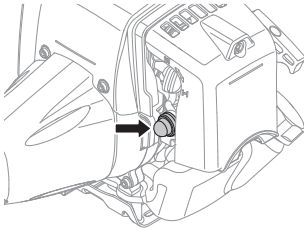

Starter: Tirer la commande de starter.

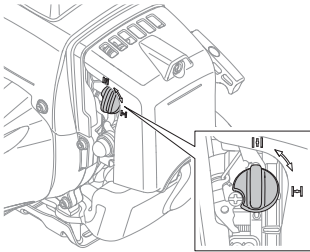

AVERTISSEMENT! Lorsque le moteur est démarré avec la commande de starter en position starter/accélérateur, l'équipement de coupe commence à tourner immédiatement.

Plaquer la machine contre le sol à l'aide de la main gauche (NOTA! Pas à l'aide du pied!). Saisir ensuite la poignée de démarrage de la main droite et tirer lentement sur le lanceur jusqu'à ce qu'une résistance se fasse sentir (les cliquets d'entraînement grippent), puis tirer énergiquement et rapidement sur le lanceur. **Ne jamais enrouler la corde du lanceur autour de la main.**

Remettre la commande de starter en position initiale dès que le moteur s'allume et continuer les essais de démarrage jusqu'à ce que le moteur démarre. Au démarrage du moteur, donner rapidement les pleins gaz pour désactiver automatiquement l'accélération de démarrage.

REMARQUE! Ne pas sortir complètement la corde du lanceur et ne pas lâcher la poignée avec la corde du

lanceur complètement sortie. Cela pourrait endommager la machine.

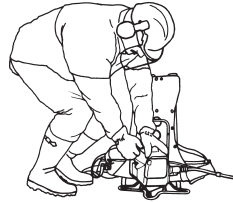

REMARQUE! Ne pas placer aucune partie du corps sur la surface marquée. Contact peut causer en brûlures à la peau ou les chocs électriques si le chapeau de bougie est defectueux. Toujours utiliser des gants. Ne jamais utiliser une machine dont le chapeau de bougie est defectueux.

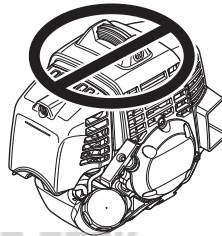

Arrêt



Pour arrêter le moteur, couper l'allumage.

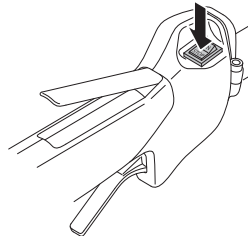

Méthodes de travail

IMPORTANT!

Ce chapitre traite des consignes de sécurité de base lors du travail avec une débroussailleuse ou un coupe-herbe.

Dans l'éventualité d'une situation rendant la suite du travail incertaine, consulter un expert. S'adresser au revendeur ou à l'atelier de réparation.

Évitez les tâches pour lesquelles vous ne vous sentez pas suffisamment qualifié.

Avant l'utilisation, il est essentiel de comprendre la différence entre le déblayage forestier, le débroussaillage et le désherbage.

Règles élémentaires de sécurité



- 1 Bien observer la zone de travail:
 - S'assurer qu'aucune personne, aucun animal ou aucun autre facteur ne risque de gêner l'utilisateur de la machine.
 - Afin d'éviter que des personnes, des animaux ou autre n'entrent en contact avec l'équipement de coupe ou avec des objets lancés par celui-ci.
 - REMARQUE! Ne jamais utiliser une machine s'il n'est pas possible d'appeler au secours en cas d'accident.
- 2 Inspecter la zone de travail. Retirer tous les objets tels que les pierres, les morceaux de verre, les clous, les fils de fer, les bouts de ficelle, etc. pouvant être projetés ou risquant de bloquer l'équipement de coupe.
- 3 Ne pas travailler par mauvais temps: brouillard épais, pluie diluvienne, vent violent, grand froid, etc. Travailler par mauvais temps est cause de fatigue et peut même être dangereux: sol glissant, direction de chute d'arbre modifiée, etc.
- 4 S'assurer de pouvoir se tenir et se déplacer en toute sécurité. Repérer les éventuels obstacles en cas de déplacement imprévu: souches, pierres, branches, fondrières, etc. Observer la plus grande prudence lors de travail sur des terrains en pente.



- 5 Utilisez toujours cet aspirateur-souffleur portable dans son harnais.
- 6 Soyez bien en équilibre, les pieds d'aplomb.
- 7 Toujours tenir la machine avec les deux mains.
- 8 L'équipement de coupe doit se trouver sous la taille de l'utilisateur.
- 9 Lors des déplacements, arrêter le moteur. Lors des déplacements longs et des transports, utiliser le dispositif de protection prévu à cet effet.
- 10 Ne jamais placer la machine sur le sol avec le moteur en marche sans pouvoir la surveiller.



AVERTISSEMENT! Ni l'utilisateur de la machine, ni qui que ce soit ne doit essayer de retirer le matériel végétal coupé tant que le moteur ou l'équipement de coupe tourne, sous peine de blessures graves.

Arrêter le moteur et l'équipement de coupe avant de retirer le matériel végétal qui s'est enroulé autour de l'axe de la lame, sous peine de blessures. Après l'utilisation, le renvoi d'angle peut être chaud pendant un moment. Risque de brûlures au contact.



AVERTISSEMENT! Attention aux objets projetés. Toujours utiliser des protections homologuées pour les yeux. Ne jamais se pencher au-dessus de la protection de l'équipement de coupe. Des cailloux, débris, etc. peuvent être projetés dans les yeux et causer des blessures très graves, voire la cécité.

Maintenir à distance toutes les personnes non concernées par le travail. Les enfants, les animaux, les spectateurs et les collègues de travail devront se trouver en dehors de la zone de sécurité, soit à au moins 15 mètres. Arrêter immédiatement la machine si une personne s'approche. Ne tournez jamais sur vous-même avec la machine sans vous assurer d'abord que personne ne se trouve dans la zone de sécurité.

Techniques de travail de base

Ramener le moteur au régime de ralenti après chaque étape de travail. Laisser le moteur tourner à pleins gaz

TECHNIQUES DE TRAVAIL

sans lui faire subir de charge peut endommager sérieusement le moteur.



AVERTISSEMENT! Il arrive que des branches ou de l'herbe se coincent entre la protection et l'équipement de coupe. Toujours arrêter le moteur avant de procéder au nettoyage.



AVERTISSEMENT! Les machines équipées de lames d'éclaircissage ou de disques à herbe peuvent être projetées violemment d'un côté quand la lame heurte un objet fixe. Ce phénomène est appelé rebond. Un rebond peut être suffisamment violent pour projeter la machine et/ou l'opérateur dans une direction quelconque et faire perdre le contrôle de la machine à l'opérateur. Les rebonds se produisent sans prévenir si la machine s'accroche sur un objet, cale ou se bloque. Un rebond est plus apte à se produire dans des zones où il est difficile de voir le matériau coupé.

Eviter d'utiliser la plage 12 h - 15 h de la lame. Du fait de la vitesse de rotation de la lame, c'est justement sur cette plage que l'éjection d'objets risque de se produire lorsque la lame est appliquée sur des troncs plus épais.

Débroussaillage avec une lame à herbe



- Ne pas utiliser les lames et les couteaux à herbe pour les tiges ligneuses.
- La lame à herbe s'utilise pour tous les types d'herbe haute ou épaisse.
- Faucher l'herbe d'un mouvement de balancier latéral, le mouvement de droite à gauche constituant la fauche et le mouvement de gauche le retour. Faire travailler la lame du côté gauche (secteur 8h à 12 h).

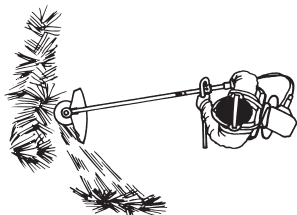

- Si on penche légèrement la lame vers la gauche pendant le débroussaillage, l'herbe coupée est disposée en bandes, ce qui facilite le ramassage, par exemple lors du ratissage.

- Essayer d'adopter un rythme de travail régulier. Prendre une position stable, les pieds écartés. Faire un pas en avant après le mouvement de retour et reprendre la même position stable.
- Laisser le bol de garde au sol. Son rôle est de protéger la lame contre tout contact avec le sol.
- Respecter les règles suivantes afin d'éviter que les matériaux ne s'enroulent autour de la lame:
 - 1 Toujours travailler en faisant tourner le moteur à plein régime.
 - 2 Éviter de toucher le matériel végétal coupé au cours du mouvement de retour.
- Arrêter le moteur, ouvrir le harnais et poser la machine par terre avant de rassembler le matériel végétal coupé.

Désherbage avec tête de désherbage



Désherbage

- Maintenir la tête de désherbage juste au-dessus du sol, l'incliner. Le travail est effectué par l'extrémité du fil. Laisser le fil travailler à son propre rythme. Ne jamais forcer le fil dans le matériau à couper.



- Le fil facilite l'enlèvement d'herbe et de mauvaises herbes au pied des murs, clôtures, arbres et massifs fleuris, mais il peut aussi endommager l'écorce des arbres et des broussailles ainsi que les poteaux des clôtures.
- Réduire les risques d'endommager la végétation en limitant la longueur du fil à 10-12 cm et en réduisant le régime moteur.

Nettoyage par grattage

- La technique du grattage permet d'enlever toute végétation indésirable. Maintenir la tête de désherbage juste au-dessus du sol, puis l'incliner. Laisser l'extrémité du fil battre le sol autour des arbres, poteaux, statues et similaires. **NOTA!** Cette technique accélère l'usure du fil.



- Le fil s'use plus vite et doit être déroulé plus souvent au contact de cailloux, briques, béton, clôtures métalliques, etc. qu'au contact d'arbres et de clôtures en bois.
- Lors du désherbage et du grattage, ne pas faire tourner le moteur tout à fait à plein régime, ceci afin que le fil dure plus longtemps et la tête de désherbage s'use moins.

TECHNIQUES DE TRAVAIL

Coupe

- Le coupe-herbe est idéal pour atteindre l'herbe aux endroits difficilement accessibles avec une tondeuse ordinaire. Maintenir le fil parallèlement au sol lors du désherbage. Éviter de presser la tête de désherbage contre le sol, puisque cela risque d'endommager la pelouse et le matériel.

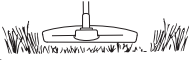

- Éviter de maintenir la tête de désherbage constamment au contact avec le sol en utilisation normale. Un contact permanent peut endommager la tête de désherbage et accélérer son usure.

Balayage

- L'effet soufflant du fil rotatif peut être utilisé pour un nettoyage simple et rapide. Maintenir le fil parallèle et au-dessus des surfaces à balayer, puis balayer l'outil suivant un mouvement de balancier.

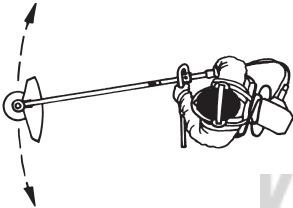

- Lors de la coupe et du balayage, faire tourner à plein régime afin d'obtenir un bon résultat.

KES VAN DER SPEK
TOEGEBORVEN * STOLWIJK

Carburateur

Réglage du ralenti (T)

Vérifier que le filtre à air est propre. Quand le ralenti est correctement réglé, l'équipement de coupe ne tourne pas. Si un réglage est nécessaire, fermer (sens des aiguilles d'une montre) le pointeau T avec le moteur en marche jusqu'à ce que l'équipement de coupe commence à tourner. Ouvrir (sens contraire des aiguilles d'une montre) le pointeau jusqu'à l'arrêt de l'équipement de coupe. Le régime de ralenti correct est atteint lorsque le moteur tourne régulièrement dans toutes les positions, avec une marge confortable jusqu'au régime auquel l'équipement de coupe commence à tourner.

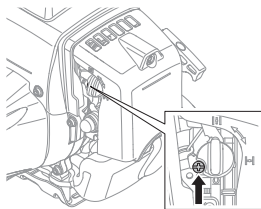

AVERTISSEMENT! S'il est impossible de régler le régime de ralenti de manière à immobiliser l'équipement de coupe, contacter le revendeur ou l'atelier de réparation. Ne pas utiliser la machine tant qu'elle n'est pas correctement réglée ou réparée.

Filtre à air



Le filtre à air doit être maintenu propre pour éviter:

- Un mauvais fonctionnement du carburateur
- Des problèmes de démarrage
- Une perte de puissance
- Une usure prématurée des éléments du moteur.
- Une consommation anormalement élevée de carburant

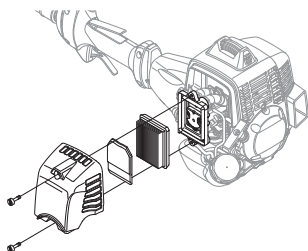

Nettoyer le filtre après 25 heures de service, ou plus souvent si les conditions de travail sont exceptionnellement poussiéreuses.

Nettoyage du filtre à air

Déposer le capot de filtre et retirer le filtre. Nettoyer le filtre avec de l'eau chaude savonneuse. S'assurer que le filtre est sec avant de le remonter.

Un filtre ayant servi longtemps ne peut plus être complètement nettoyé. Le filtre à air doit donc être remplacé à intervalles réguliers. **Tout filtre endommagé doit être remplacé immédiatement.**

Filtre à carburant

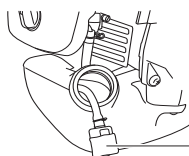

1 Filtre à carburant

Si l'approvisionnement en carburant commence à être insuffisant pour le moteur, vérifier si le bouchon du réservoir et le filtre ne sont pas obstrués.

Renvoi d'angle



Le renvoi d'angle est enduit en usine de la quantité de graisse nécessaire. Toutefois, avant d'utiliser la machine, il convient de s'assurer que le renvoi d'angle est au 3/4 rempli de graisse. Utiliser une graisse HUSQVARNA spéciale.

En général, il n'est pas nécessaire de remplacer le lubrifiant du carter, sauf en cas de réparations.

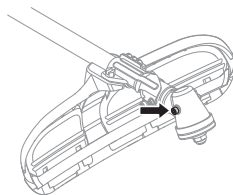

Bougie



L'état de la bougie dépend de:

- L'exactitude du réglage du carburateur.

ENTRETIEN

- Mauvais mélange de l'huile dans le carburant (trop d'huile ou huile inappropriée).
- La propreté du filtre à air.

Ces facteurs peuvent concourir à l'apparition de calamine sur les électrodes, ce qui à son tour entraîne un mauvais fonctionnement du moteur et des démarrages difficiles.

Si la puissance de la machine est trop faible, si la machine est difficile à mettre en marche ou si le ralenti est irrégulier, toujours commencer par contrôler l'état de la bougie avant de prendre d'autres mesures. Si la bougie est encrassée, la nettoyer et vérifier que l'écartement des électrodes est de 0,6-0,7 mm. Remplacer la bougie une fois par mois ou plus souvent si nécessaire.

0,6 - 0,7 mm

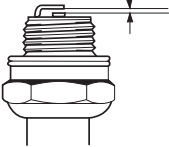

REMARQUE! Toujours utiliser le type de bougie recommandé! Une bougie incorrecte peut endommager le piston/le cylindre. S'assurer que la bougie est dotée d'un antiparasites.

Arbre d'entraînement



L'arbre d'entraînement flexible est lubrifié avec de la graisse pour arbre d'entraînement Husqvarna. L'arbre doit être lubrifié au moins tous les 6 mois.

- Lever le bouton de verrouillage maintenant la gaine de l'arbre d'entraînement au carter d'embrayage.

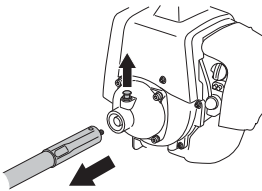

- Extraire la gaine de l'arbre d'entraînement du carter d'embrayage.
- Extraire l'arbre d'entraînement de sa gaine, soit en secouant la gaine pour faire sortir l'arbre, soit en utilisant une pince.

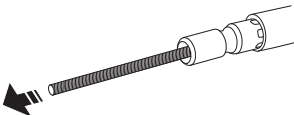

- Appliquez de la graisse sur l'ensemble de l'arbre. Étalez-la avec une brosse ou un chiffon.

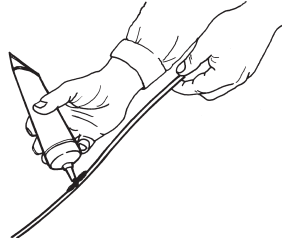

- Remettre l'arbre d'entraînement dans sa gaine. Faire tourner l'arbre tout en l'enfonçant pour bien l'enclencher.

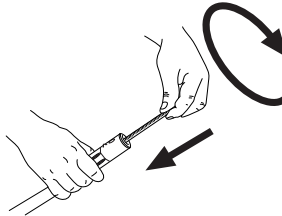

- Une fois l'arbre correctement monté dans la gaine, l'extrémité de l'arbre doit se trouver à environ 10 mm à l'extérieur du bord de la gaine.

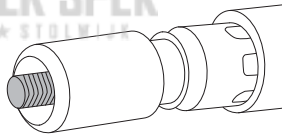

- Monter la gaine de l'arbre d'entraînement dans le carter d'embrayage de sorte que le trou se place juste en dessous du bouton de verrouillage sur le carter d'embrayage.

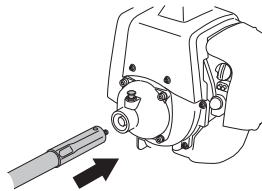

- Assurez-vous que l'arbre s'engage correctement en le tournant et le poussant en même temps.

ENTRETIEN

Schéma d'entretien

La liste ci-dessous indique l'entretien à effectuer sur la machine. La plupart des points sont décrits à la section Entretien. L'utilisateur ne peut effectuer que les travaux d'entretien et de révision décrits dans ce manuel d'utilisation. Les mesures plus importantes doivent être effectuées dans un atelier d'entretien agréé.

Entretien	Entretien quotidien	Entretien hebdomadaire	Entretien mensuel
Nettoyer l'extérieur de la machine.	X		
Vérifier que le harnais est intact.	X		
Contrôler le bon fonctionnement du verrou d'accélérateur et de l'accélérateur	X		
Contrôler que la poignée et le guidon sont entiers et solidement attachés.	X		
Contrôler le bon fonctionnement du contacteur d'arrêt.	X		
S'assurer que l'équipement de coupe ne tourne pas lorsque le moteur tourne au ralenti.	X		
Nettoyer le filtre à air. Le remplacer si nécessaire.	X		
S'assurer que la protection est intacte et qu'elle ne présente pas de fissures. Remplacer la protection si elle a subi des coups ou si elle présente des fissures.	X		
Vérifier le centrage de la lame, son affûtage et la présence d'éventuelles fissures. Une lame mal centrée provoque des vibrations pouvant endommager la machine.	X		
S'assurer que la tête de désherbage est intacte et qu'elle n'est pas fissurée. Au besoin, remplacer la tête de désherbage.	X		
Contrôler que le contre-écrou de l'équipement de coupe est serré correctement.	X		
S'assurer que la protection de transport de la lame est intacte et qu'il se fixe correctement.	X		
S'assurer que toutes les vis et tous les écrous sont bien serrés.	X		
Vérifier qu'il n'y a pas de fuite de carburant du moteur, du réservoir ou des conduits de carburant.	X		
Contrôler le démarreur et son lanceur.		X	
S'assurer que les amortisseurs ne sont pas endommagés.		X	
Nettoyer la bougie d'allumage extérieurement. Déposer la bougie et vérifier la distance entre les électrodes. Au besoin, ajuster la distance de sorte qu'elle soit de 0,6-0,7 mm, ou remplacer la bougie. S'assurer que la bougie est dotée d'un antiparasites.		X	
Nettoyer le système de refroidissement de la machine.		X	
Nettoyer le carburateur extérieurement, ainsi que l'espace autour.		X	
Vérifier que le renvoi d'angle est au 3/4 rempli de graisse. Au besoin, faire un remplissage d'appoint avec une graisse spéciale.		X	
Nettoyer le silencieux.			X
Contrôler que le filtre à carburant n'est pas contaminé ou que le tuyau de carburant ne comporte pas de fissures ou d'autres avaries. Remplacer si nécessaire.			X
Inspecter tous les câbles et connexions.			X
Vérifier l'état d'usure de l'embrayage, des ressorts d'embrayage et du tambour d'embrayage. Faire remplacer si nécessaire dans un atelier d'entretien agréé.			X
Remplacer la bougie d'allumage. S'assurer que la bougie est dotée d'un antiparasites.			X
Lubrifiez l'arbre d'entraînement avec de la graisse pour arbre d'entraînement Husqvarna.	À appliquer tous les six mois.		

CARACTÉRISTIQUES TECHNIQUES

Caractéristiques techniques

	553RBX
Moteur	
Cylindrée, cm ³	50,6
Alésage, mm	45,5
Course, mm	31,1
Régime de ralenti, tr/min	2800
Régime d'emballement maximal recommandé, tr/min	13000
Régime de l'axe sortant, tr/min	9285
Puissance moteur maxi selon ISO 8893, kW/ tr/min	2,3/9500
Silencieux avec pot catalytique	Non
Système d'allumage	
Bougie	NGK CMR7H
Écartement des électrodes, mm	0,6-0,7
Système de graissage/de carburant	
Contenance du réservoir de carburant, litres	0,8
Poids	
Poids, sans carburant, équipement de coupe et dispositifs de sécurité, kg	12,1
Émissions sonores	
(voir rem. 1)	
Niveau de puissance sonore mesuré dB(A)	117
Niveau de puissance sonore garanti L _{WA} dB(A)	118
Niveaux sonores	
(voir remarque 2)	
Pression acoustique équivalente au niveau des oreilles de l'utilisateur, mesurée selon EN ISO 11806 et ISO 22868, dB(A):	
Équipée d'une tête de désherbage (d'origine)	97
Équipée d'une lame à herbe (d'origine)	97
Niveaux de vibrations	
(voir remarque 3)	
Niveaux de vibrations équivalents (a _{hveq}) mesurés au niveau des poignées selon EN ISO 11806 et ISO 22867, en m/s ² .	
Équipée d'une tête de désherbage (d'origine), gauche/droite	2,7/3,3
Équipée d'une lame à herbe (d'origine), gauche/droite	2,7/3,8

Remarque 1 : émission sonore dans l'environnement mesurée comme puissance acoustique (L_{WA}) selon la directive UE 2000/14/CE. Le niveau de puissance sonore reporté pour la machine a été mesuré avec l'équipement de coupe d'origine qui donne le niveau le plus élevé. Le niveau de puissance sonore garanti diffère du niveau mesuré en cela qu'il prend également en compte la dispersion et les variations d'une machine à l'autre du même modèle, conformément à la directive 2000/14/CE.

Remarque 2 : Les données reportées pour le niveau de pression sonore équivalent pour la machine montrent une dispersion statistique typique (déviations standard) de 1 dB (A).

Remarque 3 : Les données reportées pour le niveau de vibrations équivalent montrent une dispersion statistique typique (déviations standard) de 1 m/s².

CARACTÉRISTIQUES TECHNIQUES

Accessoires homologués	Type	Protection pour équipement de coupe, réf.
Lame/couteau à herbe	Multi 300-3 (Ø 300 3 dents)	537 33 16-03
	Multi 275-4 (Ø 275 4 dents)	537 33 16-03
Tête de désherbage	T45x (fil Ø 2.7 - 3.3 mm)	537 33 16-03
	T55x (fil Ø 2.7 - 3.3 mm)	537 33 16-03
Bol de garde au sol	Fixe	-

Assurance de conformité UE (Concerne seulement l'Europe)

Nous, **Husqvarna AB**, SE-561 82 Huskvarna, Suède, tél: +46-36-146500, déclarons, sous notre seule responsabilité, que le produit auquel se rattache la présente déclaration: débroussailleuses **Husqvarna 553RBX** à partir des numéros de série de l'année de fabrication 2012 et ultérieurement (l'année est indiquée en clair sur la plaque d'identification et suivie d'un numéro de série) est conforme aux dispositions de la (des) DIRECTIVE(S) DU CONSEIL:

- du 17 mai 2006 "directive machines" **2006/42/CE**

- du 15 décembre 2004 "compatibilité électromagnétique" **2004/108/CEE**.

- du 8 mai 2000 "émissions sonores dans l'environnement" **2000/14/CE**. Estimation de la conformité effectuée selon l'Annexe V. Pour des informations sur les émissions sonores, voir le chapitre Caractéristiques techniques.

Les normes harmonisées suivantes ont été appliquées: **EN ISO 12100:2010, CISPR 12:2007, ISO 14865:1998**.

SMP Svensk Maskinprovning AB, Fyrisborgsgatan 3, SE-754 50 Uppsala, Suède, a procédé à des tests de type facultatifs pour le compte de Husqvarna AB.

Le certificat a le numéro: **SEC/12/2344**

Huskvarna, le 8 février 2012

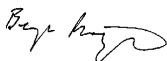

KEES VAN DER SPEK
TUINMACHINES * STOLWIJK

Bengt Frögelius, directeur du développement (Représentant autorisé d'Husqvarna AB et responsable de la documentation technique.)

SIMBOLOGIA

Simboli

AVVERTENZA! Usati in maniera impropria o negligente lo sfrascatore, il decespugliatore e il bordatore possono essere attrezzi pericolosi, in grado di provocare lesioni gravi o mortali all'utilizzatore o a terzi. È importantissimo leggere attentamente e capire queste istruzioni per l'uso.

Prima di usare la macchina, leggere per intero le istruzioni per l'uso e accertarsi di averne compreso il contenuto.

Usare sempre:

- Casco di protezione laddove sussiste il rischio di caduta di oggetti
- Protezioni acustiche omologate
- Protezione per gli occhi omologata

Regime di fuga massimo consigliato dell'albero sporgente, giri/min



Il presente prodotto è conforme alle vigenti direttive CEE.



Pericolo di proiezione di oggetti e particelle.



Durante il lavoro l'utilizzatore della macchina deve accertarsi che non ci siano persone o animali in un raggio di 15 metri.



Le macchine dotate di lame da taglio o sfalcio possono essere scagliate violentemente a lato in caso di contatto della lama con un oggetto fisso. Questo fenomeno è denominato contraccolpo della lama. La lama può amputare un braccio o una gamba. Tenere sempre persone e animali domestici ad almeno 15 metri dalla macchina.



Le frecce indicano i limiti entro i quali viene fissato l'attacco dell'impugnatura.



Accensione; starter: Portare il comando dell'aria in posizione di starter. Il comando di arresto si pone automaticamente in posizione di avviamento.



Pompa carburante.



Utilizzare sempre guanti protettivi omologati.



Usare stivali robusti e antiscivolo.



Macchina progettata esclusivamente per gruppi di taglio flessibili non metallici, cioè testine portafilo.



Emissioni di rumore nell'ambiente in base alla direttiva della Comunità Europea. L'emissione della macchina è indicata al capitolo Dati tecnici e sulla decalcomania.



Mantenere tutte le parti del corpo lontane dalle superfici calde.



I restanti simboli/decalcomanie riguardano particolari requisiti necessari per ottenere la certificazione in alcuni mercati.

Il controllo e/o la manutenzione vanno eseguiti a motore spento, con il pulsante di arresto in posizione STOP.



Utilizzare sempre guanti protettivi omologati.



E' necessario pulire con regolarità.



Controllo visivo.



INDICE

Indice

SIMBOLOGIA

Simboli 52

INDICE

Indice 53

Prima dell'avviamento osservare quanto segue: .. 53

INTRODUZIONE

Alla gentile clientela 54

CHE COSA C'È?

Cosa c'è nel decespugliatore? 55

NORME GENERALI DI SICUREZZA

Importante 56

Abbigliamento protettivo 56

Dispositivi di sicurezza della macchina 57

Attrezzatura di taglio 60

MONTAGGIO

Montaggio dell'albero di trasmissione flessibile ... 62

Collegamento di cavo dell'acceleratore e cavi
dell'interruttore di arresto 62

Montaggio dell'impugnatura a J 62

Montaggio della lama e della testina portafilo 63

Montaggio della protezione per il trasporto 64

Come indossare l'imbracatura ed agganciare il
decespugliatore 64

..... 64

..... 64

..... 64

..... 66

..... 66

..... 67

..... 68

..... 68

..... 70

..... 73

..... 73

..... 73

..... 73

..... 73

..... 74

..... 74

..... 75

..... 76

..... 77

Prima dell'avviamento osservare quanto segue:

Leggere accuratamente le istruzioni per l'uso.



AVVERTENZA! Una lunga esposizione al rumore può comportare lesioni permanenti all'udito. Usare quindi sempre cuffie di protezione omologate.



AVVERTENZA! Evitare assolutamente di modificare la versione originale della macchina senza l'autorizzazione del fabbricante. Usare sempre accessori originali. Modifiche e/o accessori non autorizzati possono causare lesioni gravi o mortali all'operatore o a terzi.



AVVERTENZA! Usati in maniera impropria o negligente lo sfrascatore, il decespugliatore e il bordatore possono essere attrezzi pericolosi, in grado di provocare lesioni gravi o mortali all'utilizzatore o a terzi. È importantissimo leggere attentamente e capire queste istruzioni per l'uso.

INTRODUZIONE

Alla gentile clientela

Congratulazioni per aver scelto di acquistare un prodotto Husqvarna! Le origini della Husqvarna risalgono al 1689 quando il re Karl XI fece costruire una fabbrica sulle rive del fiume Huskvarnaån per la produzione di moschetti. La posizione sul fiume Huskvarnaån è spiegata dal fatto che il fiume veniva usato per produrre energia, rappresentando così una vera e propria centrale idroelettrica. Durante gli oltre 300 anni della sua esistenza, l'azienda Husqvarna ha fabbricato innumerevoli prodotti, dalle stufe a legna fino ai moderni elettrodomestici, dalle macchine da cucire alle biciclette e alle motociclette. Nel 1956 venne lanciato il primo rasaerba a motore, seguito dalla motosega nel 1959 ed è proprio questo il settore di competenza odierno della Husqvarna.

La Husqvarna è oggi uno dei leader mondiali nella produzione di articoli per giardinaggio e silvicoltura, con qualità e prestazioni come priorità assoluta. L'idea commerciale si basa sullo sviluppo, la produzione e la commercializzazione di prodotti a motore destinati a giardinaggio e silvicoltura ed anche al settore edilizio e a quello dell'installazione di impianti. La Husqvarna vuole inoltre essere all'avanguardia per quanto concerne l'ergonomia, le esigenze dell'operatore, la sicurezza e il rispetto dell'ambiente, motivi per cui sono state introdotte una serie di innovazioni tecnologiche al fine di migliorare i prodotti da questi punti di vista.

Siamo convinti che sarete pienamente soddisfatti della qualità e delle prestazioni del nostro prodotto per un lungo tempo a venire. L'acquisto di uno dei nostri prodotti vi garantisce l'accesso alla competenza di personale qualificato per l'assistenza e le riparazioni in caso di necessità. Se non avete acquistato la macchina presso uno dei nostri rivenditori autorizzati, rivolgetevi alla più vicina officina di assistenza.

Ci auguriamo che rimarrete soddisfatti della vostra macchina e speriamo di potervi servire per molto tempo in futuro. Non dimenticate che questo manuale delle istruzioni è un documento di valore. Seguendone il contenuto (uso, assistenza, manutenzione ecc.) potrete aumentare notevolmente la durata della vostra macchina e anche il suo valore di usato. Se vendete la macchina, ricordate di consegnare il manuale delle istruzioni al nuovo proprietario.

La ringraziamo per aver scelto un prodotto Husqvarna.

La Husqvarna AB procede costantemente allo sviluppo dei propri prodotti e si riserva quindi il diritto di apportare, senza alcun preavviso, modifiche riguardanti fra l'altro la forma e l'aspetto esteriore.

KEES VAN DER SPEK
TUINMACHINES ★ STOLWIJK

CHE COSA C'È?

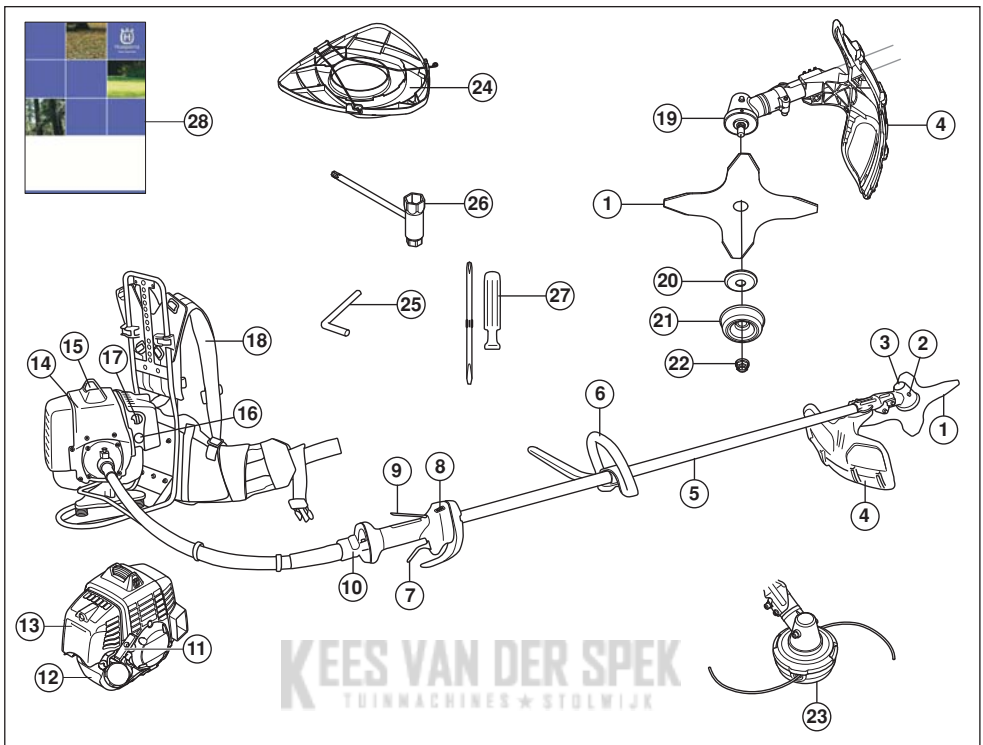

Cosa c'è nel decespugliatore?

- | | |
|---|--------------------------------------|
| 1 Lama | 15 Cappuccio della candela e candela |
| 2 Rifornimento lubrificante, riduttore angolare | 16 Pompa carburante. |
| 3 Riduttore angolare | 17 Comando valvola dell'aria |
| 4 Protezione del gruppo di taglio | 18 Imbracatura |
| 5 Albero cavo | 19 Menabrida |
| 6 Impugnatura ad anello | 20 Flangia di sostegno |
| 7 Comando del gas | 21 Coppetta di supporto |
| 8 Interruttore di arresto | 22 Dado di bloccaggio |
| 9 Fermo del gas | 23 Testina portafilo |
| 10 Raccordo dell'albero cavo | 24 Protezione per trasporto |
| 11 Maniglia di avviamento | 25 Spina di bloccaggio |
| 12 Serbatoio carburante | 26 Chiave del dado della lama |
| 13 Coperchio filtro aria | 27 Cacciavite |
| 14 Coperchio del cilindro | 28 Istruzioni per l'uso |

NORME GENERALI DI SICUREZZA

Importante

IMPORTANTE!

La macchina è destinata alle sole operazioni di bordatura e di sfoltimento dell'erba.

I soli accessori per azionare i quali vi è permesso l'uso del motore sono i gruppi di taglio da noi consigliati nel capitolo Dati tecnici.

Non usare la macchina in condizioni di stanchezza o sotto l'effetto di alcool o medicinali in grado di compromettere il vostro stato psichico e il controllo dei vostri atti.

Usare sempre abbigliamento protettivo. Vedi istruzioni alla voce Abbigliamento protettivo.

Non usare mai una macchina che abbia subito modifiche tali da non corrispondere più alle specifiche originali.

Non usare mai una macchina difettosa. Seguire le istruzioni per l'uso e la manutenzione indicate nel presente manuale. Alcuni interventi devono essere eseguiti da personale specializzato. Vedi istruzioni alla voce Manutenzione.

Tutti i carter, le protezioni e le impugnature devono essere montati prima di avviare la macchina. Accertarsi che il cappuccio della candela e il cavo di accensione non siano danneggiati per evitare il rischio di scossa elettrica.

Durante il lavoro, l'utilizzatore deve accertarsi che non ci siano persone o animali in un raggio di 15 metri. Nel caso in cui più utilizzatori stiano lavorando nello stesso luogo la distanza di sicurezza deve essere pari ad almeno il doppio della lunghezza dell'albero, e in ogni caso non inferiore a 15 metri.



AVVERTENZA! Questa macchina genera un campo elettromagnetico durante il funzionamento che in determinate circostanze può interferire con impianti medici attivi o passivi. Per ridurre il rischio di gravi lesioni personali o mortali, i portatori di tali impianti devono consultare il proprio medico e il relativo produttore prima di utilizzare la macchina.



AVVERTENZA! Un motore acceso in un ambiente chiuso o mal ventilato può essere causa di morte per soffocamento o avvelenamento da monossido di carbonio.



AVVERTENZA! Non consentire mai a bambini di utilizzare la macchina o avvicinarsi a essa. Poiché la macchina è dotata di contatto di arresto con ritorno a molla e può avviarsi a bassa velocità con una leggera trazione dell'impugnatura di avviamento, in alcune condizioni la macchina potrebbe essere avviata anche da bambini piccoli. Sussiste il rischio di gravi lesioni personali. Staccare quindi il cappuccio dalla candela quando si lascia la macchina incustodita.

Abbigliamento protettivo

IMPORTANTE!

Usati in maniera impropria o negligente lo sfrascatore, il decespugliatore e il bordatore possono essere attrezzi pericolosi, in grado di provocare lesioni gravi o mortali all'utilizzatore o a terzi. È importantissimo leggere attentamente e capire queste istruzioni per l'uso.

Lavorando con la macchina usare sempre abbigliamento protettivo omologato. L'uso di abbigliamento protettivo non elimina i rischi di lesioni, ma riduce gli effetti del danno in caso di incidente. Consigliatevi con il vostro rivenditore di fiducia per la scelta dell'attrezzatura adeguata.



AVVERTENZA! Far sempre attenzione a segnali di allarme o chiamate quando usate le cuffie protettive. Togliere sempre le cuffie protettive immediatamente all'arresto del motore.

CASCO

Casco di protezione laddove sussiste il rischio di caduta di oggetti



CUFFIE PROTETTIVE

Usare cuffie protettive con effetto insonorizzante adeguato.



NORME GENERALI DI SICUREZZA

PROTEZIONE PER GLI OCCHI

Usare sempre protezione per gli occhi omologata. Con l'uso della visiera è necessario anche l'uso di occhiali protettivi omologati. Con il termine occhiali protettivi omologati si intendono occhiali che siano conformi alle norme ANSI Z87.1 per gli USA o EN 166 per i paesi EU.



GUANTI

Usare i guanti quando è necessario, per es. durante il montaggio del gruppo di taglio.



STIVALI

Usare stivali robusti e antistrucchiolo.



ABBIGLIAMENTO

Usare abbigliamento in materiale robusto ed evitare indumenti troppo ampi che si impigliano facilmente fra rami e sterpi. Usare sempre pantaloni lunghi di tessuto resistente. Non indossare gioielli, pantaloni corti o sandali e non lavorare a piedi nudi. Accertarsi che i capelli non scendano al di sotto delle spalle.

PRONTO SOCCORSO

Tenere sempre a portata di mano la cassetta di pronto soccorso.



Dispositivi di sicurezza della macchina

In questo capitolo vengono presentati i dispositivi di sicurezza della macchina, la loro funzione, il controllo e la manutenzione necessari per assicurarne una funzione ottimale. Vedi al capitolo Che cosa c'è?, per individuare la posizione di questi componenti sulla macchina.

La durata della macchina può ridursi e il rischio di incidenti aumentare se la manutenzione non viene eseguita correttamente e se l'assistenza e/o le riparazioni non vengono effettuate da personale qualificato. Per ulteriori informazioni rivolgersi alla più vicina officina di assistenza.

IMPORTANTE! Tutte le riparazioni e l'assistenza della macchina vanno eseguite da personale specializzato. Questo vale soprattutto per i dispositivi di sicurezza. Se la macchina non supera tutti i controlli sottoelencati, contattare l'officina autorizzata. L'acquisto di uno dei nostri prodotti garantisce l'assistenza di personale qualificato. Se non avete acquistato la macchina presso un rivenditore con centro di assistenza, informatevi sull'ubicazione della più vicina officina autorizzata.



AVVERTENZA! Non usare mai una macchina con dispositivi di sicurezza guasti. Questi dispositivi vanno controllati e sottoposti a manutenzione secondo quanto descritto in questo capitolo. Se la macchina non supera tutti i controlli, contattare un'officina per le necessarie riparazioni.

Fermo del gas

Il fermo del gas impedisce le accelerazioni involontarie. Quando il fermo (A) viene premuto nell'impugnatura (mentre si impugna la motosega), si libera il comando del gas (B). Rilasciando l'impugnatura l'acceleratore e il fermo si bloccano nella loro posizione di riposo. Questo meccanismo è azionato da due molle di ritorno indipendenti. In questa posizione il gas è bloccato automaticamente sul minimo.

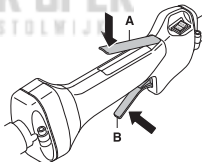

Controllare che l'acceleratore sia bloccato sul minimo quando il fermo è in posizione di riposo.

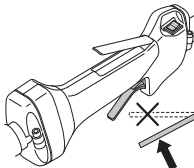

Premere sul fermo del gas e controllare che ritorni in posizione di riposo non appena viene rilasciato.

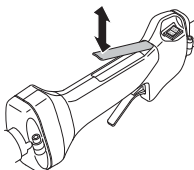

NORME GENERALI DI SICUREZZA

Controllare che acceleratore e fermo del gas si muovano liberamente e che le molle di richiamo funzionino a dovere.

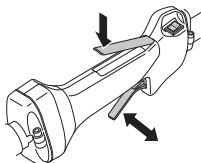

Vedi istruzioni alla voce Avviamento. Avviare il motore ed accelerare a pieno gas. Lasciar andare l'acceleratore e accertarsi che il gruppo di taglio si fermi e resti fermo. Se il gruppo di taglio ruota mentre l'acceleratore è al minimo è necessario controllare la registrazione del minimo sul carburatore. Vedi istruzioni alla voce Manutenzione.

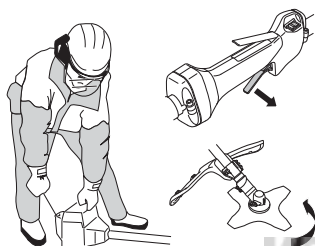

Interruttore di arresto

L'interruttore di arresto serve a spegnere il motore.

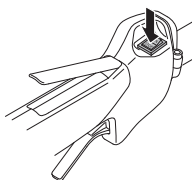

Mettere in moto e controllare che il motore si spenga portando l'interruttore in posizione di arresto.

Protezione del gruppo di taglio

Questa protezione mira ad impedire che vengano lanciati oggetti dal gruppo di taglio contro l'utilizzatore. Inoltre la protezione impedisce che l'utilizzatore venga a contatto con il gruppo di taglio.

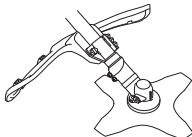

Controllare che la protezione sia integra e priva di incrinature. Sostituire la protezione se è stata sottoposta a urti o se è incrinata.

Usare sempre la protezione consigliata per ogni specifico gruppo di taglio. Vedi capitolo Dati tecnici.



AVVERTENZA! Non usare mai in nessun caso alcun gruppo di taglio senza che sia stato montato un dispositivo di protezione omologato. Vedi capitolo Dati tecnici. Il montaggio di un dispositivo di protezione inadeguato o difettoso può provocare gravi lesioni alle persone.

Sistema di smorzamento delle vibrazioni



Il sistema di smorzamento delle vibrazioni adottato, elimina la maggior parte delle vibrazioni che si sviluppano durante l'uso della macchina.

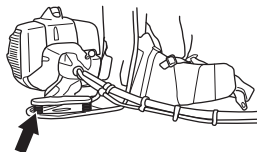

L'uso di un filo avvolto nel modo errato o di un gruppo di taglio non affilato o inadeguato (di tipo errato o affilato in modo errato, vedi istruzioni alla voce Affilatura della lama) aumenta il livello di vibrazioni.

Il sistema di smorzamento delle vibrazioni della macchina ne riduce la propagazione tra gruppo motore/gruppo di taglio e impugnatura.

Controllare con regolarità che gli smorzatori non siano deformati o lesi. Controllare che gli elementi ammortizzatori siano integri e ben fissati.



AVVERTENZA! L'esposizione eccessiva alle vibrazioni può causare lesioni neurovascolari a chi soffre di disturbi circolatori. In caso di sintomi riferibili ad un'esposizione eccessiva alle vibrazioni contattare il medico. Tali sintomi possono essere torpore, perdita della sensibilità, "punture", "prurito", dolore, riduzione o perdita della forza, decolorazioni della pelle o modifiche strutturali della sua superficie. Tali sintomi si riscontrano soprattutto nelle mani, nei polsi e alle dita. Il rischio può aumentare con le basse temperature.

Marmitta

La marmitta è costruita in modo da assicurare il minimo livello di rumorosità e da allontanare i gas di scarico del motore dall'operatore. La marmitta con catalizzatore è

NORME GENERALI DI SICUREZZA

inoltre concepita per ridurre le sostanze nocive nei gas di scarico.

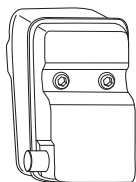

Non usare mai la macchina se la marmitta è in cattive condizioni.



Controllare con regolarità che la marmitta sia ben fissa nella macchina.

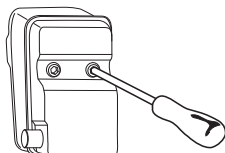

Se la macchina è dotata di marmitta con retina parascintille, questa va pulita regolarmente con una spazzola di metallo. Se la retina è ostruita il motore si surriscalda e può danneggiarsi seriamente.



AVVERTENZA! La marmitta catalitica è molto calda sia durante l'esercizio che all'arresto del motore. Questo vale anche con il motore al minimo. Il contatto può provocare ustioni. Attenzione al pericolo di incendio!



AVVERTENZA! L'interno della marmitta contiene sostanze chimiche che potrebbero essere cancerogene. Evitare il contatto con queste sostanze in caso di marmitta danneggiata.



AVVERTENZA! Non dimenticate che: I gas di scarico del motore sono molto caldi e possono contenere scintille in grado di provocare incendi. Non avviare mai la macchina in ambienti chiusi o vicino a materiale infiammabile!

Dado di bloccaggio

Su alcuni tipi di gruppo di taglio si usa il dado di bloccaggio per fissare l'utensile.



Durante il montaggio, avvitare il dado girando in senso contrario a quello di rotazione del gruppo di taglio. Durante lo smontaggio, svitare il dado nel senso di rotazione del gruppo di taglio. (NOTA! La filettatura del dado è sinistrorsa.) Serrare il dado della lama con l'apposita chiave.

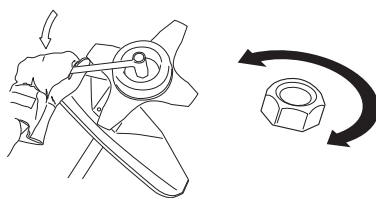

Il blocco di nylon del dado di bloccaggio non deve essere talmente usurato da poter essere girato a mano. Il blocco deve sopportare almeno 1,5 Nm. Quando è stato avvitato circa 10 volte, il dado va sostituito.

Imbracatura



Controllare che l'imbracatura sia integra.

In una situazione di emergenza, rilasciare la macchina e l'imbracatura secondo il seguente metodo.

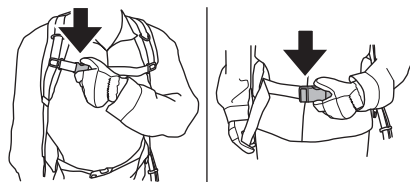

NORME GENERALI DI SICUREZZA

Attrezzatura di taglio

Questa parte vi indica, con la corretta manutenzione e l'uso del tipo di attrezzatura di taglio, come:

- Ridurre la tendenza al contraccolpo della macchina.
- Ottenere sempre le migliori prestazioni di taglio.
- Aumentare la durata dell'attrezzatura di taglio.

IMPORTANTE!

Usare solo gruppi di taglio abbinati ai tipi di protezione da noi raccomandati! Vedi capitolo Dati tecnici.

Per un corretto montaggio del filo e per la scelta di un filo dal diametro adatto vedere le istruzioni per il gruppo di taglio.

Mantenere i denti della lama affilati accuratamente e nel modo giusto! Seguire le nostre indicazioni. Vedere anche le istruzioni sulla confezione della lama.



AVVERTENZA! Spegner sempre il motore prima di eseguire qualsiasi operazione sul gruppo di taglio. Questo infatti continua a ruotare anche quando l'acceleratore viene rilasciato. Accertarsi che il gruppo di taglio sia completamente fermo e staccare il cavo dalla candela prima d'iniziare qualunque operazione.



AVVERTENZA! Un gruppo di taglio errato o una lama affilata in modo sbagliato aumentano il rischio di contraccolpi.

Attrezzatura di taglio

La lama tagliaerba e il coltello tagliaerba sono adatti allo sfoltimento dell'erba più folta.



La testina portafilo è adatta per la bordatura dell'erba.



Regole basilari



Usare solo gruppi di taglio abbinati ai tipi di protezione da noi raccomandati! Vedi capitolo Dati tecnici.

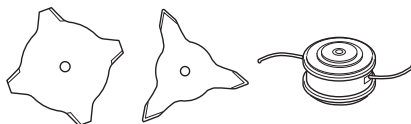

Mantenere i denti della lama adeguatamente affilati! Seguire le nostre istruzioni ed usare la sagoma di affilatura consigliata. Una lama mal affilata o danneggiata aumenta il rischio d'incidenti.

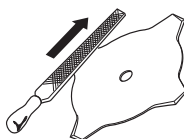

Controllare il gruppo di taglio per individuare danni o incrinature. Un gruppo di taglio danneggiato dev'essere sostituito.



Affilatura del coltello tagliaerba e della lama tagliaerba

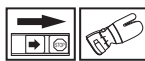

- Per una corretta affilatura vedere la confezione del gruppo di taglio. La lama e il coltello si affilano con una lima piatta a taglio semplice.
- Per mantenere l'equilibratura, limare ugualmente tutti i taglienti.

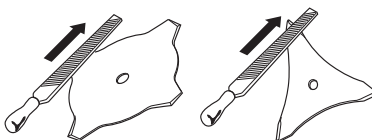

AVVERTENZA! Rottamare sempre la lama che sia piegata, contorta, lesionata, incrinata o danneggiata in altro modo. Non provate mai a raddrizzare una lama piegata per riutilizzarla. Usare solo lame originali del tipo raccomandato.

Testina portafilo

IMPORTANTE!

Controllare che il filo di taglio sia ben avvolto attorno al rocchetto, onde evitare pericolose vibrazioni nella macchina.

- Usare solo le testine portafilo ed i fili di taglio di tipo consigliato. Essi sono stati collaudati dal fabbricante ed adattati in base alla grandezza del motore. Ciò è particolarmente importante se si usano testine automatiche. Usare solamente i gruppi di taglio consigliati. Vedi capitolo Dati tecnici.



- In genere una macchina piccola richiede una testina portafilo piccola e viceversa. Questo dipende dal fatto che il motore durante l'esercizio deve far ruotare il filo allontanandolo in senso radiale dalla testina e contemporaneamente superare la resistenza opposta dall'erba.
- Anche la lunghezza del filo è importante. A parità di diametro, un filo lungo richiede maggiore potenza rispetto a uno corto.
- Assicurarsi che il coltellino situato sulla protezione della testina sia intatto. Esso serve a tagliare il filo alla giusta lunghezza.
- Per prolungare la vita del filo esso può essere immerso in acqua per un paio di giorni. Il filo diventa così più tenace e dura di più.

KEES VAN DER SPEK
TUINMACHINES ★ STOLWIJK

MONTAGGIO

Montaggio dell'albero di trasmissione flessibile



- Allentare le due viti del raccordo dell'albero cavo.

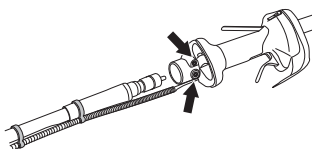

- Far scorrere l'albero flessibile attraverso gli anelli del cavo e innestare l'albero flessibile nel raccordo dell'albero cavo. Assicurarsi che l'albero si innesti correttamente, ruotando e premendo allo stesso tempo.
- Serrare le due viti.
- Montare la guaina dell'albero di trasmissione nel coperchio della frizione facendo in modo che il foro venga a trovarsi al centro sotto il pulsante di bloccaggio sul coperchio della frizione.

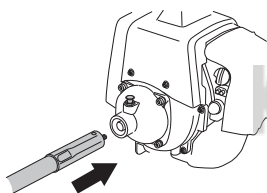

- Assicurarsi che l'albero si innesti correttamente, ruotando e premendo allo stesso tempo.
- Accertarsi che la spina di bloccaggio ritorni nella posizione originaria in modo che il manicotto dell'albero di trasmissione non possa staccarsi dalla custodia della frizione.

Collegamento di cavo dell'acceleratore e cavi dell'interruttore di arresto



- Posizionare il cavetto dell'acceleratore dal cavo (A) e il cavetto dell'acceleratore dal motore (B) nel manicotto di plastica come indicato.

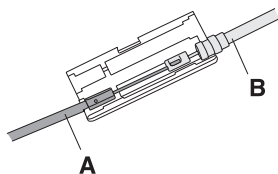

- Chiudere il manicotto di plastica.

- Inserire i cavi dell'interruttore di arresto nei connettori del motore corrispondenti. Da notare che la polarità del cavo non è importante.

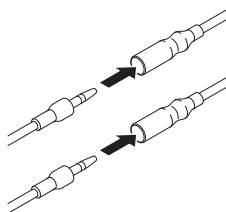

Montaggio dell'impugnatura a J



- Situare l'impugnatura sull'albero cavo. Osservare che l'impugnatura dev'essere montata al di sotto della freccia segnata sull'albero cavo.

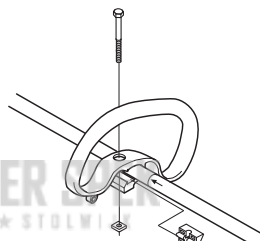

- Inserire il distanziale nella guida dell'impugnatura ad anello.
- Montare il dado e la vite. Non serrare troppo.
- L'impugnatura a J viene montata nell'impugnatura ad anello con tre viti come in figura.

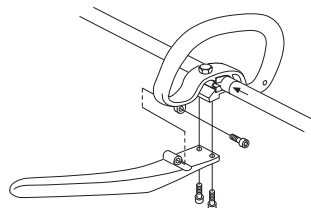

- Eseguire ora la regolazione finale in modo da ottenere una comoda posizione di lavoro con il bordatore. Serrare le vite/manopola.

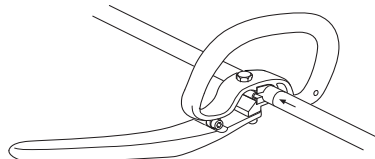

MONTAGGIO



AVVERTENZA! Con il montaggio dell'impugnatura a J è possibile utilizzare solo lama/coltello tagliaerba oppure testina portafilò/coltelli in plastica. Non usare mai una lama per sfrascatura con l'impugnatura a J.

Montaggio della lama e della testina portafilò



AVVERTENZA! Durante il montaggio del gruppo di taglio è di estrema importanza fare in modo che la guida del menabrida/flangia di supporto sia situato nel modo corretto nel foro centrale del gruppo di taglio. Un gruppo di taglio montato in modo errato può causare lesioni molto gravi e/o perfino mortali.

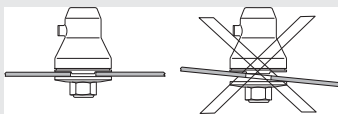

AVVERTENZA! Non usare mai in nessun caso alcun gruppo di taglio senza che sia stato montato un dispositivo di protezione omologato. Vedi capitolo Dati tecnici. Il montaggio di un dispositivo di protezione inadeguato o difettoso può provocare gravi lesioni alle persone.

IMPORTANTE! Per poter usare una lama per sfrascatura o una lama tagliaerba la macchina deve essere dotata di manubrio, paralama e imbracatura adeguati.

Installazione del carter protettivo



N.B! Utilizzando testina portafilò/coltelli in plastica e protezione multipla, il carter protettivo deve essere sempre installato. Utilizzando coltello tagliaerba e protezione multipla, il carter protettivo deve essere smontato.

Il paralama/protezione multipla (A) viene agganciato al supporto sull'albero cavo e fissato con una vite.

Allineare la guida del carter protettivo alla scanalatura della protezione multipla. Agganciare quindi il carter protettivo alla protezione con i quattro fermi rapidi.

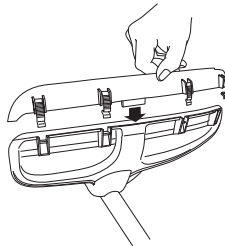

Lo smontaggio del carter protettivo si effettua semplicemente utilizzando il cacciavite (vedere figura).

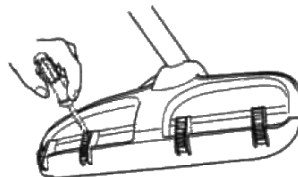

Montaggio di paralama, lama tagliaerba e coltello tagliaerba



- Il paralama/protezione multipla (A) viene agganciato al supporto sull'albero cavo e fissato con una vite (L). Usare il paralama di tipo consigliato. Vedi istruzioni alla voce Caratteristiche tecniche. N.B! Accertarsi che il carter protettivo sia smontato.

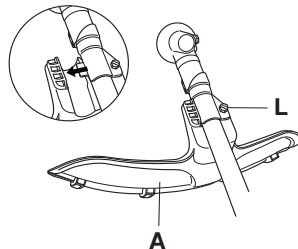

- Montare il menabrida (B) sull'alberino sporgente.
- Far ruotare l'alberino portalama fino a far coincidere uno dei fori del menabrida con il foro corrispondente nell'alloggiamento del riduttore.
- Introdurre nel foro la spina di bloccaggio (C) per bloccare l'alberino.
- Collocare la lama (D), la coppetta di sostegno (E) e la flangia di sostegno (F) sull'alberino sporgente.
- Montare il dado (G). Esso va serrato con una coppia di 35-50 Nm (3,5-5 kpm). Usare la chiave a bussola inclusa nel kit attrezzi. Mantenere il manico della

MONTAGGIO

chiave il più possibile vicino al paralama. Per serrare il dado girare la chiave in senso contrario a quello di rotazione (NOTA! filettatura sinistrorsa).

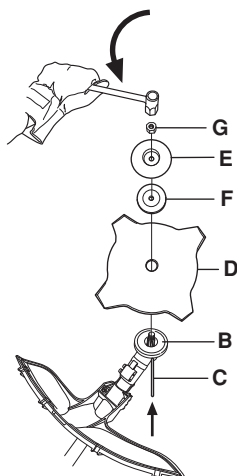

Montaggio di protezione della testina e testina portafilo



- Montare la protezione della testina (A) per le operazioni con la testina portafilo. N.B! Accertarsi che il carter protettivo sia installato.

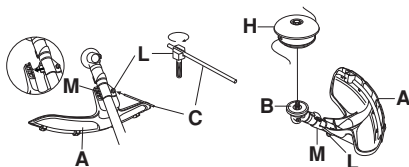

- La protezione della testina/protezione multipla viene agganciata al supporto sull'albero cavo e fissata con 1 vite (L).
- Montare il menabrida (B) sull'alberino sporgente.
- Far ruotare l'alberino portalama fino a far coincidere uno dei fori del menabrida con il foro corrispondente nell'alloggiamento del riduttore.
- Introdurre nel foro la spina di bloccaggio (C) per bloccare l'alberino.

- Avvitare la testina portafilo/coltelli in plastica (H) in senso contrario al movimento di rotazione.

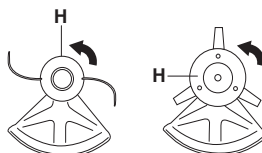

- Per smontare procedere in ordine inverso.

Montaggio della protezione per il trasporto



- Montare il disco sulla protezione per il trasporto (A).
- Fare scattare i due dispositivi di fissaggio (B) nelle scanalature (C) per assicurare la protezione per il trasporto.

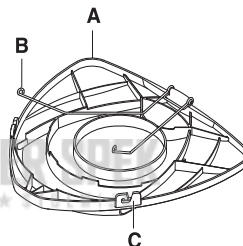

Come indossare l'imbracatura ed agganciare il decespugliatore



Regolazione dell'altezza dello schienale

- Allentare i due dispositivi di fissaggio che trattengono lo schienale.

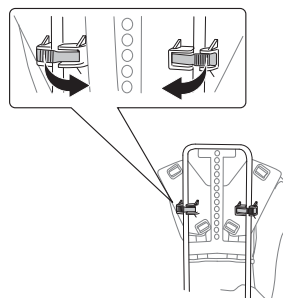

MONTAGGIO

- Allentare lo schienale da un lato del telaio.

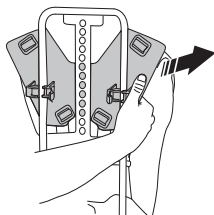

- Spostare lo schienale all'altezza desiderata e fissarlo. Verificare che il perno sia allineato con uno dei fori del telaio, vedere immagine.

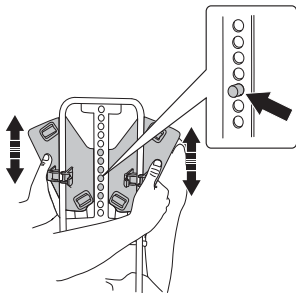

Regolazione dell'imbracatura

- Indossare l'imbracatura.
- Tendere la cinghia in corrispondenza della vita in modo che sia ben fissa.



- Serrare le cinghia.



- Regolare la cinghia verticalmente se necessario e verificare che sia posizionata correttamente.

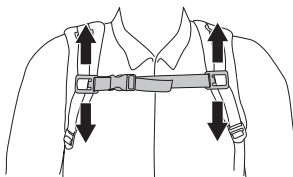

- Regolare le cinghie sulle spalle in modo da distribuirvi uniformemente il carico.



- Allentare o serrare la cinghia in corrispondenza della vita in modo che circa il 70% del carico si trovi sulla vita e il 30% sulle spalle.

KEES VAN DER SPEK
TUINMACHINES * STOLWIJK

OPERAZIONI CON IL CARBURANTE

Carburante

Non accendere mai la macchina:

- 1 Se è stato versato del carburante sulla macchina. Eliminare ogni traccia di sporco e lasciare evaporare i resti di benzina.
- 2 Se avete versato del carburante su voi stessi o sui vostri abiti, cambiare abiti. Lavare le parti del corpo che sono venute a contatto con il carburante. Usare acqua e sapone.
- 3 Se vi sono perdite di carburante nella macchina. Controllare con regolarità la presenza di eventuali perdite dal tappo del serbatoio o dai tubi di alimentazione.

Trasporto e rimessaggio

- Il rimessaggio e il trasporto della macchina e del carburante devono essere eseguiti in modo che eventuali perdite o vapori non rischino di venire a contatto con scintille o fiamme aperte, generate ad esempio da macchine elettriche, motori elettrici, contatti/interruttori o caldaie.
- Per il rimessaggio e il trasporto del carburante usare recipienti adeguati ed omologati per tale scopo.
- In caso di rimessaggio della macchina per un periodo prolungato il serbatoio del carburante va svuotato. Per l'eliminazione dei resti inutilizzati di carburante rivolgersi al più vicino distributore di benzina.
- Accertarsi che la macchina sia ben pulita e che sia stata sottoposta a tutte le operazioni di assistenza prima di ogni rimessaggio a lungo termine.
- Durante il trasporto e il rimessaggio della macchina la protezione per il trasporto deve essere sempre montata sul gruppo di taglio.
- Mettere in sicurezza la macchina durante il trasporto.



AVVERTENZA! Il carburante va maneggiato con cautela. Tenere presenti i rischi d'incendio, esplosione e intossicazione in caso di aspirazione.

Carburante

N.B! La macchina è dotata di motore a due tempi che deve sempre funzionare con una miscela di benzina e olio per motori a due tempi. Per assicurare una corretta miscelazione, misurare con cura la quantità d'olio da mescolare alla benzina. Se la quantità di carburante è limitata, anche un piccolo errore nella quantità d'olio influisce notevolmente sulla miscela.



AVVERTENZA! Il carburante e i vapori tossici sono altamente infiammabili e la loro inalazione o il contatto cutaneo possono provocare gravi lesioni. Agire dunque con cautela maneggiando il carburante e assicurare una buona ventilazione dell'ambiente durante l'operazione.

Benzina



N.B! Utilizzare sempre benzina di alta qualità, minimo 90 ottani (RON), miscelata a olio. Se la macchina è dotata di marmitta catalitica (vedere il capitolo Dati tecnici), utilizzare sempre benzina senza piombo di alta qualità miscelata a olio. La benzina contenente piombo danneggia la marmitta catalitica.

Usare nei casi in cui sia possibile una benzina ecologica, la cosiddetta benzina alchilata.



- Il numero minimo di ottani raccomandato è 90 (RON). Se si utilizza una benzina con un numero di ottani inferiore a 90, il motore può strappare. In tal caso la temperatura del motore aumenta e possono verificarsi gravi avarie.
- In caso di uso continuo ad alto regime si raccomanda una benzina ad alto numero di ottani.

Olio per motori a due tempi

- Per un risultato ottimale, utilizzare l'olio per motori a due tempi HUSQVARNA, studiato appositamente per i nostri motori a due tempi con raffreddamento ad aria.
- Non utilizzare mai olio per motori a due tempi formulato per motori fuoribordo con raffreddamento ad acqua (outboardoil - TCW).
- Non usare mai olio per motori a quattro tempi.
- Un olio di qualità scadente o una miscela carburante/olio troppo ricca può pregiudicare il corretto funzionamento della marmitta e ridurne la vita utile.
- Miscela
1:50 (2%) con olio per motori a due tempi HUSQVARNA.
1:33 (3%) con altri oli per motori a due tempi con raffreddamento ad aria classificati a norma JASO FB/ISO EGB.

OPERAZIONI CON IL CARBURANTE

Benzina, litri	Olio per motori a due tempi, litri	
	2% (1:50)	3% (1:33)
5	0,10	0,15
10	0,20	0,30
15	0,30	0,45
20	0,40	0,60

Preparazione della miscela

- Preparare la miscela in recipiente pulito e a parte, omologato per la benzina.
- Iniziare con il versare metà della benzina da usare. Aggiungere tutto l'olio. Mescolare agitando. Versare la benzina rimanente.
- Mescolare (agitare) accuratamente prima di procedere al rifornimento.

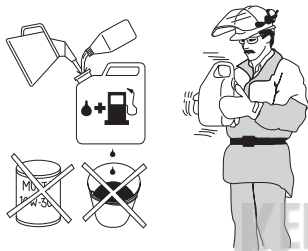

- Preparare una quantità di miscela necessaria al massimo per un mese.
- In caso di rimessaggio prolungato, vuotare e pulire il serbatoio del carburante.



AVVERTENZA! La marmitta catalitica è molto calda durante l'uso e subito dopo l'arresto del motore. Questo vale anche con il motore al minimo. Attenzione al pericolo di incendio, specialmente in presenza di materiali e/o gas infiammabili.

Rifornimento



AVVERTENZA! I seguenti accorgimenti diminuiscono il pericolo di incendio:

Non fumare o portare sorgenti di calore vicino al carburante.

Effettuare sempre il rifornimento a motore spento.

Spegnere il motore e lasciarlo raffreddare alcuni minuti prima del rifornimento.

Aprire il tappo del serbatoio con cautela, per eliminare eventuali sovrappressioni.

Dopo il rifornimento chiudere bene il tappo.

Allontanare sempre la macchina dal luogo e dalla fonte di rifornimento prima della messa in moto.

- Utilizzare una tanica carburante con protezione anti-traboccamento.
- Pulire tutt'intorno al tappo del serbatoio. La presenza d'impurità nel serbatoio può causare guasti.
- Agitare il contenitore della miscela prima di versarla nel serbatoio per assicurarsi che essa sia ben mescolata.



Min 3 m
(10 ft)



AVVIAMENTO E ARRESTO

Controlli prima dell'avviamento



- Non usare mai la macchina senza protezione o con una protezione difettosa.
- Tutti i coperchi devono essere correttamente montati e integri prima dell'avviamento della macchina.
- Controllare la lama per accertarsi che non vi siano incrinature sul fondo dei denti o presso il foro centrale. Le cause più frequenti delle incrinature sono il formarsi di angoli acuti sui fondi dei denti durante l'affilatura e l'uso della lama con i denti non affilati. In caso di incrinature gettare via la lama.

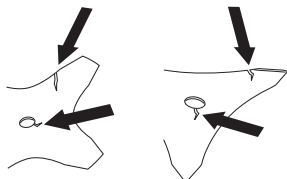

- Controllare la flangia di sostegno assicurandosi che non si siano formate incrinature dovute ad affaticamento o ad un serraggio eccessivo. In caso di incrinature, gettare via la flangia.

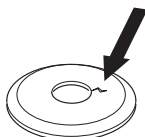

- Controllare che il dado non abbia perso la sua capacità di bloccaggio. Il blocco del dado deve sopportare una coppia di almeno 1,5 Nm. La coppia di serraggio del dado deve corrispondere a 35-50 Nm.



- Controllare il paralama e verificare che non abbia subito lesioni o incrinature. Sostituire il paralama nel caso in cui abbia subito degli urti o presenti delle incrinature.

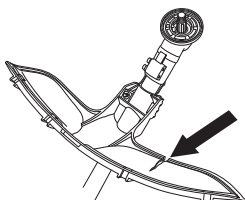

- Controllare la testina portafilo e la protezione della testina e verificare che siano intatte e non presentino incrinature. Sostituire la testina portafilo o la

protezione della testina nel caso in cui abbiano subito degli urti o presentino incrinature.

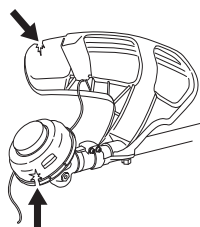

Avviamento e arresto



AVVERTENZA! Prima di avviare la macchina il coperchio della frizione completo e l'albero cavo devono essere montati, altrimenti la frizione potrebbe staccarsi e causare danni alle persone.

Allontanare sempre la macchina dal luogo e dalla fonte di rifornimento prima della messa in moto. Collocare la macchina su una solida base d'appoggio. Controllare che il gruppo di taglio non possa venire a contatto con corpi solidi.

Verificare che nella zona operativa non siano presenti persone non addette ai lavori, che sarebbero esposte al rischio di gravi lesioni. La distanza di sicurezza corrisponde a 15 metri.

Avviamento



Accensione: Spingere l'interruttore di arresto in posizione di avviamento.

Pompa carburante: Premere più volte sulla sacca in gomma della pompa fino a quando la sacca comincia a

AVVIAMENTO E ARRESTO

riempirsi di carburante. Non è necessario che la sacca sia completamente piena.

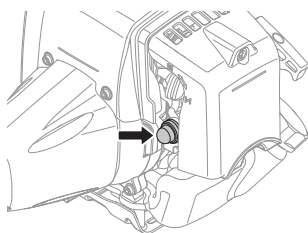

Aria: Portare il comando dell'aria in posizione di starter.

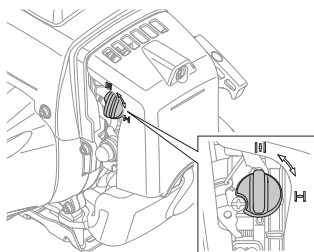

AVVERTENZA! Accendendo il motore con il comando della valvola dell'aria in posizione di arricchimento o di avviamento il gruppo di taglio inizia immediatamente a ruotare.

Premere il corpo della macchina contro il terreno con la mano sinistra (NOTA! Non con il piede!). Afferrare la manopola di avviamento, estrarre lentamente la cordicella di avviamento con la mano destra fino a quando si avverte resistenza (i ganci di avviamento entrano in azione) e tirare con movimenti rapidi e decisi. **Non avvolgere mai la cordicella di avviamento intorno alla mano.**

Riportare immediatamente la valvola dell'aria in posizione iniziale quando il motore comincia ad accendersi e ripetere i tentativi fino all'avviamento. Accelerare quindi velocemente a tutto gas e il gas di avviamento si disinnesterà automaticamente.

N.B! Non estrarre completamente la cordicella e non lasciare la maniglia di avviamento con la cordicella estratta. Questo potrebbe danneggiare la macchina.

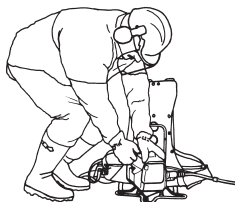

N.B! Evitare di toccare la superficie contrassegnata con qualunque parte del corpo. Il contatto può provocare ustioni o scossa elettrica se il cappuccio della candela è difettoso. Usare sempre i guanti. Non usare mai la macchina se il cappuccio della candela è difettoso.

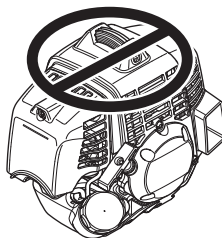

Arresto



Il motore si arresta immediatamente agendo sull'interruttore.

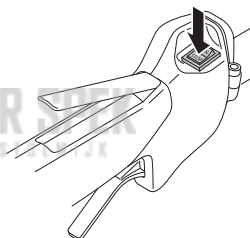

TECNICA DI LAVORO

Istruzioni generali di lavoro

IMPORTANTE!

Questo capitolo comprende le regole fondamentali di sicurezza per il lavoro con decespugliatore e bordatore.

Trovandosi in una situazione di insicurezza riguardo all'uso della macchina rivolgersi ad un esperto. Contattare il proprio rivenditore o l'officina di servizio.

Evitare qualsiasi lavoro per il quale non ci si sente sufficientemente qualificati.

Prima dell'uso dovete comprendere la differenza fra sfoltimento forestale, sfoltimento dell'erba e bordatura dell'erba.

Norme basilari di sicurezza



- 1 Osservare l'ambiente circostante:
 - Per escludere la presenza di persone, animali o altro che possa interferire sul vostro controllo della macchina.
 - Per impedire che persone, animali o altro possano rischiare di entrare a contatto con il gruppo di taglio o che oggetti possano essere scagliati in aria dal gruppo di taglio.
 - N.B! Non usare mai la macchina se non siete certi di poter chiedere aiuto in caso d'infortunio.
- 2 Controllare l'area di lavoro. Asportare eventuali corpi estranei quali pietre, frammenti di vetro, chiodi, fili di ferro, corde ecc. che potrebbero essere scagliati oppure penetrare nel gruppo di taglio.
- 3 Evitare di lavorare in condizioni di tempo sfavorevoli. Ad esempio nebbia, pioggia intensa, vento forte ecc. Il lavorare con tempo cattivo è spesso stancante e comporta situazioni di rischio, come ad esempio il terreno scivoloso, cambio di direzione di caduta dell'albero ecc.
- 4 Accertarsi di poter camminare e lavorare in posizione sicura. In caso di spostamenti, controllare che non vi siano ostacoli (ceppi, radici, rami, fossati ecc.) Fare particolare attenzione lavorando su terreni in pendenza.



- 5 Indossare sempre il soffiatore a zaino utilizzando l'apposita tracolla durante l'uso.
- 6 Mantenere una posizione ben salda ed equilibrata.
- 7 Mantenere sempre una presa sicura della macchina con entrambe le mani.
- 8 Tenere il gruppo di taglio al di sotto della vita.
- 9 Gli spostamenti vanno sempre eseguiti a motore spento. In caso di spostamenti su distanze più lunghe o di trasporti usare la protezione di trasporto.
- 10 Non poggiare mai la macchina a motore acceso se non la si può tenere bene d'occhio.



AVVERTENZA! Non cercare mai di rimuovere il materiale tagliato con il motore in moto o il gruppo di taglio in rotazione. Esiste il rischio di ferirsi gravemente e ciò vale sia per l'operatore che per eventuali terzi.

Arrestare il motore e il gruppo di taglio prima di rimuovere il materiale avvolto intorno all'albero della lama; in caso contrario esiste il rischio di ferirsi gravemente. Durante e/o alcuni attimi dopo l'uso è possibile che il riduttore angolare sia caldo. Il contatto può implicare il rischio di ustioni.



AVVERTENZA! Rischio di oggetti volanti. Usare sempre una protezione per gli occhi omologata. Evitate di lavorare inclinati verso la protezione del gruppo di taglio. Esiste il rischio di venir colpiti agli occhi da sassi o altri corpi estranei il che potrebbe causare cecità o altre gravi lesioni.

Mantenere sempre distanti i non addetti ai lavori. Bambini, animali, assistenti e anche eventuali spettatori devono sempre essere tenuti ad una distanza di sicurezza di 15 metri. Arrestare immediatamente la macchina nel caso qualcuno si avvicini. Non girarsi mai con la macchina in azione senza prima aver controllato che non ci sia nessuno alle vostre spalle entro la zona di sicurezza.

Tecnica fondamentale di lavoro

Dopo ciascuna fase di lavoro decelerare il motore fino al regime minimo. Un esercizio prolungato a pieno regime senza carico può causare gravi danni al motore.



AVVERTENZA! A volte rami o erba possono incastrarsi tra la protezione e il gruppo di taglio. Spegnerne sempre il motore prima della pulizia.

TECNICA DI LAVORO



AVVERTENZA! Le macchine dotate di lame da taglio o sfalcio possono essere scagliate violentemente a lato in caso di contatto della lama con un oggetto fisso. Questo fenomeno è denominato **contraccolpo della lama**. Il contraccolpo della lama può essere sufficientemente violento per scagliare la macchina e/o l'operatore in qualsiasi direzione ed eventualmente provocare la perdita di controllo della macchina. Il contraccolpo della lama si può verificare senza alcun segno di stallo o funzionamento irregolare della macchina. Il contraccolpo della lama si può verificare più facilmente nei punti in cui è difficile vedere il materiale tagliato.

Evitare di segare con il settore di lama che è compreso tra le posizioni ore 12 e ore 3. Per la velocità di rotazione della lama vi è rischio di contraccolpi, se questa parte della lama viene avvicinata a tronchi di grosso spessore.

- Fare in modo che la coppetta di sostegno si appoggi leggermente al terreno. La coppetta di sostegno serve a proteggere la lama dal contatto con il terreno.
- Per evitare che il tagliato si aggrovigli intorno alla lama è bene seguire le seguenti indicazioni:
 - 1 Lavorare sempre a pieno gas.
 - 2 Evitare il materiale appena tagliato nel movimento di ritorno.
- Arrestare il motore, sganciare l'imbracatura ed appoggiare a terra la macchina prima di raccogliere il materiale tagliato.

Bordatura dell'erba con testina portafilo



Bordatura

- Mantenere la testina portafilo a poca distanza dal terreno ed angolarla. E' l'estremità del filo che esegue il taglio. Lasciare che il filo funzioni al proprio ritmo. Non premere mai il filo contro il materiale da tagliare.



- Il filo elimina facilmente l'erba e le erbacce vicino a muri, recinti, alberi ed aiuole, ma può anche danneggiare la corteccia di alberi e cespugli oppure i paletti dei recinti.
- Per ridurre i danni alle piante accorciare il filo fino a 10-12 cm e ridurre il regime del motore.

Estirpazione di erbacce

- La tecnica di estirpazione rimuove tutta la vegetazione indesiderata. Tenere la testina portafilo appena al di sopra del terreno ed inclinarla. Lasciare che l'estremità del filo colpisca il terreno attorno ad alberi, pilastri, statue o simili. **NOTA!** Questo metodo comporta una maggiore usura del filo.



- Se si lavora contro pietre, mattoni, cemento, recinzioni metalliche ecc. il filo si consuma più rapidamente che non a contatto con alberi o steccati in legno.
- Durante la bordatura e l'estirpazione di erbacce mantenere il regime al di sotto del massimo, per far sì che il filo duri di più e la testina portafilo si usuri di meno.

Rasatura

- Il bordatore è ideale per tagliare l'erba in punti che un normale rasaerba difficilmente può raggiungere. Durante il taglio mantenere il filo parallelo al terreno. Evitare di premere la testina portafilo contro il terreno

Sfoltimento dell'erba con lama tagliaerba



- Le lame tagliaerba e i coltelli tagliaerba non possono essere usati per i tronchi legnosi.
- Per tutti i tipi di erba alta o robusta si usa la lama tagliaerba.
- L'erba viene falciata con movimenti oscillanti lateralmente, in cui il movimento da destra a sinistra costituisce il momento di falciatura mentre il movimento da sinistra a destra è il movimento di ritorno. Lavorare col lato sinistro della lama (prendendo ad esempio l'orologio, la posizione sarebbe fra le 8 e le 12).

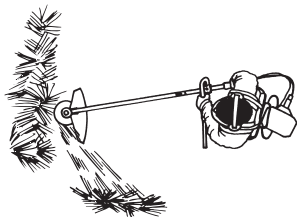

- Inclinando leggermente la lama verso sinistra durante lo sfoltimento, l'erba forma un'andana che ne facilita la raccolta col rastrello.
- Cercare di lavorare con movimenti ritmici. Assumere una posizione stabile con i piedi divaricati. Dopo il movimento di ritorno avanzare e riassumere una posizione stabile.

TECNICA DI LAVORO

perché in questo modo si rischia di rovinare il manto erboso e di danneggiare l'utensile.

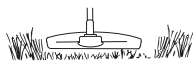

- Durante le normali operazioni di taglio evitare che la testina portafilo sia a contatto prolungato col terreno. Un contatto costante potrebbe danneggiare o usurare la testina.

Spazzare

- Lo spostamento d'aria causato dal filo rotante può essere utilizzato per spazzare in modo facile e veloce. Mantenere il filo parallelo e al di sopra delle superfici da spazzare e muovere l'utensile avanti e indietro.

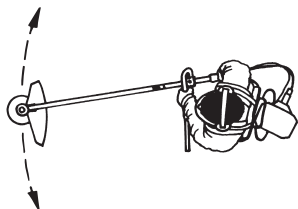

- Per rasare o spazzare procedere a pieno gas per ottenere un buon risultato.

KEES VAN DER SPEK
TUINMACHINES ★ STOLWIJK

Carburatore

Regolazione del minimo (T)

Controllare che il filtro dell'aria sia pulito. Quando il minimo è registrato correttamente, il gruppo di taglio non deve girare. Se è necessaria una regolazione, chiudere (in senso orario) la vite T con il motore in moto fino a quando il gruppo di taglio non comincia a girare. Riaprire (in senso antiorario) la vite fino a quando il gruppo di taglio si ferma. Il regime del minimo è correttamente impostato, quando il motore gira uniformemente in tutte le posizioni, con un buon margine prima del regime in cui il gruppo di taglio comincia a girare.

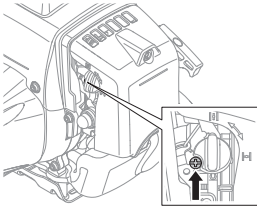

AVVERTENZA! Se non è possibile regolare il regime del minimo affinché il gruppo di taglio si fermi, contattate il rivenditore/servizio di assistenza. Evitate di utilizzare la macchina prima che questa sia stata correttamente regolata o riparata.

Filtro dell'aria



Pulire regolarmente il filtro dell'aria per evitare :

- Disturbi di carburazione
- Problemi di messa in moto
- Riduzione della potenza sviluppata
- Inutile usura dei componenti del motore
- Consumi più elevati.

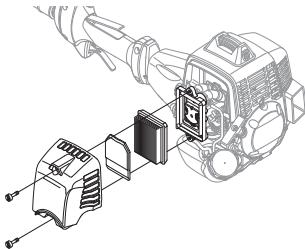

Il filtro dev'essere pulito ogni 25 ore di esercizio o più spesso se l'ambiente è estremamente polveroso.

Pulizia del filtro dell'aria

Smontare il coperchio del filtro dell'aria ed estrarre il filtro. Lavarlo in acqua saponata calda. Prima di rimontare il filtro accertarsi che sia ben asciutto.

Il filtro non ritorna mai completamente pulito. Pertanto va sostituito periodicamente con uno nuovo. **Un filtro danneggiato va sostituito immediatamente.**

Filtro del carburante

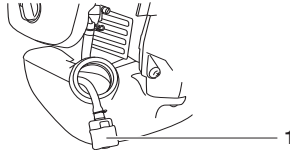

1 Filtro del carburante

Quando non arriva più carburante al motore, controllare che il tappo del serbatoio o il filtro del carburante non siano intasati.

Riduttore angolare



Il riduttore angolare è stato riempito in fabbrica con la giusta quantità di grasso. Prima dell'uso della macchina si consiglia comunque di controllare che il riduttore sia pieno di grasso fino a 3/4. Usare grasso speciale HUSQVARNA.

Il lubrificante nell'alloggiamento del riduttore non va normalmente cambiato se non in caso di eventuali riparazioni.

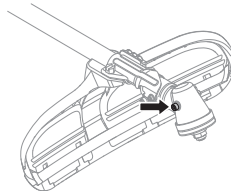

Candela



Lo stato della candela dipende da:

- Carburatore non tarato.
- Miscela carburante/olio non corretta (quantità eccessiva di olio oppure olio non idoneo).
- Filtro dell'aria ostruito .

MANUTENZIONE

Questi fattori causano depositi sull'elettrodo della candela, e conseguenti disturbi di funzionamento e di messa in moto.

Se la macchina ha potenza insoddisfacente, difficoltà di messa in moto o il minimo irregolare, controllare innanzitutto la candela. Se questa è incrostata, pulirla e controllare la distanza tra gli elettrodi, che deve essere 0,6-0,7 mm. La candela andrebbe cambiata di regola dopo circa un mese di esercizio o prima se necessario.

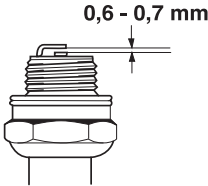

N.B! Usare candele originali o di tipo raccomandato! Altre candele possono danneggiare cilindro e pistone. Controllare che la candela sia munita di dispositivo di soppressione interferenze radio.

Albero di trasmissione



L'asse motrice flessibile viene lubrificato con grasso per assi motrici Husqvarna. L'asse deve essere lubrificato almeno ogni 6 mesi.

- Sollevare il pulsante di bloccaggio che mantiene la guaina dell'albero di trasmissione nel coperchio della frizione.

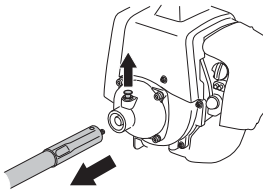

- Estrarre la guaina dell'albero di trasmissione dal coperchio della frizione.
- Estrarre l'albero di trasmissione dalla guaina scuotendolo leggermente o estraendolo con una pinza.

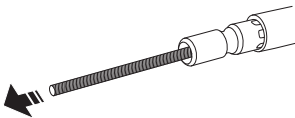

- Applicare il grasso con il tubetto lungo l'intero asse. Stendere con una spazzola o un panno.

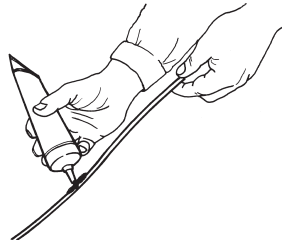

- Infilare di nuovo l'albero di trasmissione nella guaina. Controllare che l'albero entri nella sede facendolo girare e premendolo contemporaneamente verso il basso.

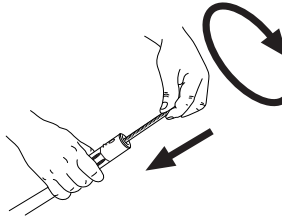

- L'albero è montato correttamente nella guaina quando la sua estremità fuoriesce dal bordo della guaina di circa 10 mm.

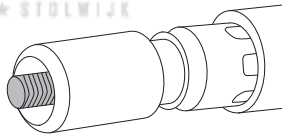

- Montare la guaina dell'albero di trasmissione nel coperchio della frizione facendo in modo che il foro venga a trovarsi al centro sotto il pulsante di bloccaggio sul coperchio della frizione.

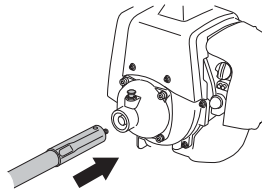

- Assicurarsi che l'albero si innesti correttamente, ruotando e premendo allo stesso tempo.

MANUTENZIONE

Schema di manutenzione

Qui di seguito troverete una lista delle operazioni di manutenzione da eseguire sulla macchina. La maggior parte dei punti è descritta al capitolo Manutenzione. L'utilizzatore può eseguire solo le operazioni di manutenzione e assistenza descritte in questo manuale delle istruzioni. Per operazioni di maggiore entità rivolgersi ad un'officina autorizzata.

Manutenzione	Manutenzione giornaliera	Manutenzione settimanale	Manutenzione mensile
Pulire le parti esterne della macchina.	X		
Controllare che l'imbracatura sia integra.	X		
Controllare che il blocco dell'acceleratore e l'acceleratore funzionino in modo sicuro.	X		
Controllare che l'impugnatura ed il manubrio siano integri e fissati correttamente.	X		
Controllare che l'interruttore d'arresto funzioni.	X		
Controllare che il gruppo di taglio non ruoti con il motore al minimo.	X		
Pulire il filtro dell'aria. Sostituire se necessario.	X		
Controllare che la protezione sia integra e priva di incrinature. Sostituire la protezione se è stata sottoposta a urti o se è incrinata.	X		
Controllare che la lama sia ben centrata, ben affilata e priva di incrinature. Una lama non centrata produce vibrazioni che possono danneggiare la macchina.	X		
Controllare che la testina portafilo sia integra e priva di incrinature. Sostituirla se necessario.	X		
Controllare che il dado di bloccaggio del gruppo di taglio sia correttamente serrato.	X		
Controllare che la protezione di trasporto della lama sia integra e che possa essere montata correttamente.	X		
Controllare che dadi e viti siano ben serrati.	X		
Controllare che non ci siano perdite di carburante nel motore, nel serbatoio o nei flessibili carburante.	X		
Controllare il dispositivo di avviamento con la relativa cordicella.		X	
Controllare l'integrità degli smorzatori di vibrazioni.		X	
Pulire la candela esternamente. Smontarla e controllare la distanza fra gli elettrodi. Regolare la distanza portandola a 0,6-0,7 mm o sostituire la candela. Controllare che la candela sia munita di dispositivo di soppressione interferenze radio.		X	
Pulire l'impianto di raffreddamento della macchina.		X	
Pulire il carburatore esternamente e lo spazio attorno ad esso.		X	
Controllare che il riduttore angolare sia pieno per 3/4 di grasso. Riempire con grasso speciale se necessario.		X	
Pulire la marmitta.			X
Controllare che il filtro del carburante non sia sporco e che il flessibile del carburante non presenti incrinature o altri difetti. Sostituire se necessario.			X
Controllare tutti i cavi e i collegamenti.			X
Controllare che la frizione, le molle della frizione e il tamburo della frizione non siano usurati. Sostituire se necessario presso un'officina autorizzata.			X
Sostituire la candela. Controllare che la candela sia munita di dispositivo di soppressione interferenze radio.			X
Ingrassare l'asse motrice con grasso per assi motrici Husqvarna.	L'operazione deve essere effettuata ogni sei mesi.		

CARATTERISTICHE TECNICHE

Caratteristiche tecniche

	553RBX
Motore	
Cilindrata, cm ³	50,6
Alesaggio, mm	45,5
Corsa, mm	31,1
Regime del motore al minimo, giri/min	2800
Regime di massima raccomandato, giri/min	13000
Regime albero sporgente, giri/min	9285
Potenza max. motore a norma ISO 8893, kW/ giri/min.	2,3/9500
Marmitta catalitica	No
Sistema di accensione	
Candela	NGK CMR7H
Distanza all'elettrodo, mm	0,6-0,7
Carburante, lubrificazione	
Capacità serbatoio carburante, litri	0,8
Peso	
Peso, escluso carburante, gruppo di taglio e protezione, kg	12,1
Emissioni di rumore	
(vedere annot. 1)	
Livello potenza acustica, misurato dB(A)	117
Livello potenza acustica, garantito L _{WA} dB(A)	118
Livelli di rumorosità	
(vedi nota 2)	
Livello di pressione acustica equivalente rispetto all'udito dell'operatore, misurato in base alle norme EN ISO 11806 e ISO 22868, dB(A):	
Equipaggiata con testina portafilo (originale)	97
Equipaggiata con lama tagliaerba (originale)	97
Livelli di vibrazioni	
(vedi nota 3)	
Livelli di vibrazione equivalenti (a _{hV,eq}) all'impugnatura, misurati in base alle norme EN ISO 11806 e ISO 22867, in m/s ²	
Equipaggiata con testina portafilo (originale), sinistra/destra	2,7/3,3
Equipaggiata con lama tagliaerba (originale), sinistra/destra	2,7/3,8

Nota 1: Emissione di rumore nell'ambiente misurato come potenza acustica (L_{WA}) in base alla direttiva CE 2000/14/CE. Il livello di potenza acustica riportato per la macchina è stato misurato con il gruppo di taglio originale che emette il livello massimo. La differenza tra potenza acustica misurata e garantita è che la potenza acustica garantita comprende anche la dispersione nel risultato di misurazione e le variazioni tra le diverse macchine dello stesso modello come da Direttiva 2000/14/CE.

Nota 2: I dati riportati per il livello di pressione acustica equivalente della macchina hanno una dispersione statistica tipica (deviazione standard) di 1 dB (A).

Nota 3: I dati riportati per il livello di vibrazione equivalente hanno una dispersione statistica tipica (deviazione standard) di 1 m/s².

CARATTERISTICHE TECNICHE

Accessori omologati	Tipo	Protezione per gruppo di taglio, Art. no.
Lama/coltello tagliaerba	Multi 300-3 (Ø 300 3 denti)	537 33 16-03
	Multi 275-4 (Ø 275 4 denti)	537 33 16-03
Testina portafilo	T45x (cavo Ø 2,7 - 3,3 mm)	537 33 16-03
	T55x (cavo Ø 2,7 - 3,3 mm)	537 33 16-03
Coppetta di supporto	Fissa	-

Dichiarazione di conformità CE (Solo per l'Europa)

La **Husqvarna AB**, SE-561 82 Huskvarna, Svezia, tel +46-36-146500, dichiara con la presente che i decespugliatori **Husqvarna 553RBX** a partire dai numeri di serie del 2012 in poi (l'anno viene evidenziato nel marchio di fabbrica ed è seguito da un numero di serie) sono conformi alle disposizioni della DIRETTIVA DEL CONSIGLIO:

- del 17 maggio 2006 "sulle macchine" **2006/42/CE**

- del 15 dicembre 2004 "sulla compatibilità elettromagnetica" **2004/108/CE**.

- dell'8 maggio 2000 "sull'emissione di rumore nell'ambiente" **2000/14/CE**. Valutazione della conformità eseguita ai sensi dell'Allegato V. Per informazioni relative alle emissioni di rumore, vedi capitolo Dati tecnici.

Sono state applicate le seguenti norme: **EN ISO 12100:2010, CISPR 12:2007, ISO 14865:1998**.

L'SMP, Svensk Maskinprovning AB, Fyrisborgsgatan 3, SE-754 50 Uppsala, Svezia, ha eseguito il controllo-tipo facoltativo per conto della Husqvarna AB.

Il certificato porta il numero: **SEC/12/2344**

Huskvarna 8 febbraio 2012

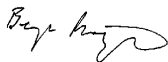

KEES VAN DER SPEK

Bengt Frögelius, Responsabile ricerca e sviluppo (Rappresentante autorizzato per Husqvarna AB e responsabile della documentazione tecnica.)

SYMBOLERKLÄRUNG

Symbole

WARNUNG! Falsch oder nachlässig angewendete Freischneider, Motorsensen oder Trimmer sind gefährliche Geräte, die schwere Verletzungen oder tödliche Unfälle von Anwendern oder anderen Personen verursachen können. Es ist sehr wichtig, dass Sie den Inhalt dieser Bedienungsanweisung lesen und verstehen.

Lesen Sie die Bedienungsanweisung sorgfältig durch und machen Sie sich mit dem Inhalt vertraut, bevor Sie das Gerät benutzen.

Benutzen Sie immer:

- Schutzhelm in Bereichen, in denen Gefahr für von oben herabfallende Gegenstände besteht
- Einen zugelassenen Gehörschutz
- Zugelassener Augenschutz

Max. Drehzahl der Abtriebswelle, U/ min



Dieses Produkt stimmt mit den geltenden CE-Richtlinien überein.



Warnung vor hochgeschleuderten und abfallenden Gegenständen.



Der Anwender des Geräts hat darauf zu achten, dass während der Arbeit keine Menschen oder Tiere näher als 15 m herankommen.



Maschinen mit Säge- oder Grasklingen können heftig zur Seite geschleudert werden, wenn die Klinge auf einen festen Gegenstand trifft. Dies wird als Klingenstoß bezeichnet. Die Klinge kann Arme oder Beine durchtrennen. Menschen oder Tiere müssen sich stets mindestens 15 m von der Maschine entfernt aufhalten.



Pfeile, die die Grenzen für die Platzierung des Handgriffhalters markieren.



Zündanlage; Choke: Choker in Chokestellung bringen. Der Stoppschalter muss dabei automatisch in Startstellung wechseln.



Kraftstoffpumpe.



Stets zugelassene Schutzhandschuhe tragen.



Rutschfeste und stabile Stiefel tragen.



Nur für nichtmetallische, flexible Schneidusrüstungen bestimmt, d. h. für Trimmerköpfe mit Trimmerfäden.



Umweltbelastende Geräuschemissionen gemäß der Richtlinie der Europäischen Gemeinschaft. Die Emission des Gerätes ist im Kapitel Technische Daten und auf dem Geräteschild angegeben.



Sämtliche Körperteile von heißen Oberflächen fernhalten.



Sonstige Symbole/Aufkleber am Gerät beziehen sich auf spezielle Zertifizierungsanforderungen, die in bestimmten Ländern gelten.

Eine Kontrolle und/oder Wartung ist bei abgestelltem Motor vorzunehmen, wenn der Stoppschalter in Stellung STOP steht.



Stets zugelassene Schutzhandschuhe tragen.



Regelmäßige Reinigung ist notwendig.



Visuelle Kontrolle.



INHALT

Inhalt

SYMBOLERKLÄRUNG

Symbole 78

INHALT

Inhalt 79

Vor dem Start ist Folgendes zu beachten: 79

EINLEITUNG

Sehr geehrter Kunde! 80

WAS IST WAS?

Was ist was am Freischneider? 81

ALLGEMEINE SICHERHEITSVORSCHRIFTEN

Wichtig 82

Persönliche Schutzausrüstung 82

Sicherheitsausrüstung des Gerätes 83

Schneidausrüstung 86

MONTAGE

Montage der flexiblen Antriebswelle 88

Beschleunigungskabel und Ein-/Ausschalterdraht
anschießen 88

Montage des J-Handgriffs 88

Montage von Klinge und Trimmerkopf 89

Montage des Transportschutzes 90

Anpassung von Tragegurt und Freischneider 90

UMGANG MIT KRAFTSTOFF

Sicherer Umgang mit Kraftstoff 92

Kraftstoff 92

Tanken 93

STARTEN UND STOPPEN

Kontrolle vor dem Start 94

Starten und stoppen 94

ARBEITSTECHNIK

Allgemeine Arbeitsvorschriften 96

WARTUNG

Vergaser 99

Luftfilter 99

Kraftstofffilter 99

Winkelgetriebe 99

Zündkerze 99

Antriebswelle 100

Wartungsschema 101

TECHNISCHE DATEN

Technische Daten 102

EG-Konformitätserklärung 103

Vor dem Start ist Folgendes zu beachten:

Die Bedienungsanweisung sorgfältig durchlesen.



WARNUNG! Eine längerfristige Beschallung mit Lärm kann zu bleibenden Gehörschäden führen. Daher stets einen zugelassenen Gehörschutz tragen.



WARNUNG! Unter keinen Umständen darf die ursprüngliche Konstruktion des Gerätes ohne Genehmigung des Herstellers geändert werden. Es ist immer Originalzubehör zu verwenden. Unzulässige Änderungen und/oder unzulässiges Zubehör können zu schweren oder sogar tödlichen Verletzungen des Anwenders oder anderer Personen führen.



WARNUNG! Falsch oder nachlässig angewendete Freischneider, Motorsensen oder Trimmer sind gefährliche Geräte, die schwere Verletzungen oder tödliche Unfälle von Anwendern oder anderen Personen verursachen können. Es ist sehr wichtig, dass Sie den Inhalt dieser Bedienungsanweisung lesen und verstehen.

EINLEITUNG

Sehr geehrter Kunde!

Herzlichen Glückwunsch zu Ihrem Kauf eines Husqvarna-Produkts! Husqvarnas Geschichte reicht bis ins Jahr 1689 zurück, als König Karl XI eine Fabrik an den Ufern des Flusses Huskvarna errichten ließ, in der Musketen gefertigt werden sollten. Die Lage am Huskvarna bot sich an, da der Fluss zur Erzeugung von Wasserkraft verwendet wurde und so als Wasserkraftwerk diente. In den mehr als 300 Jahren seit dem Bestehen des Husqvarna-Werks wurden unzählige Produkte hergestellt, angefangen von Holzöfen bis hin zu modernen Küchenmaschinen, Nähmaschinen, Fahr- und Motorrädern usw. 1956 wurde der erste Motorrasenmäher auf den Markt gebracht, gefolgt von der Motorsäge 1959, und in diesem Bereich ist Husqvarnas auch heute tätig.

Husqvarna ist gegenwärtig einer der weltführenden Hersteller von Forst- und Gartenmaschinen und legt vor allem Wert auf Qualität und Leistungskraft. Das Unternehmenskonzept umfasst die Entwicklung, Herstellung und den Vertrieb von Produkten für den Einsatz in Wald und Garten sowie in der Bauindustrie. Husqvarnas Ziel ist es, auch in den Bereichen Ergonomie, Benutzerfreundlichkeit, Sicherheit und Umwelt führend zu sein – dies lässt sich an vielen Details erkennen, die aus diesen Gesichtspunkten heraus entwickelt wurden.

Wir sind überzeugt, dass Sie mit der Qualität und Leistung unserer Produkte über lange Jahre mehr als zufrieden sein werden. Mit dem Erwerb unserer Produkte erhalten Sie professionelle Hilfe bei Reparaturen und Service, falls doch einmal etwas passieren sollte. Haben Sie die Maschine nicht bei einem unserer Vertragshändler gekauft, fragen Sie dort nach der nächsten Servicewerkstatt.

Wir hoffen, dass Sie mit Ihrer Maschine über lange Jahre zufrieden sein werden. Denken Sie daran, diese Bedienungsanleitung sicher aufzubewahren. Die genaue Befolgung ihres Inhalts (Verwendung, Service, Wartung usw.) verlängert die Lebensdauer der Maschine erheblich und erhöht zudem ihren Wiederverkaufswert. Sollten Sie Ihre Maschine verkaufen, händigen Sie dem neuen Besitzer bitte auch die Bedienungsanleitung aus.

Vielen Dank, dass Sie sich für ein Husqvarna-Produkt entschieden haben.

Die Husqvarna AB arbeitet ständig an der Weiterentwicklung ihrer Produkte und behält sich daher das Recht auf Änderungen ohne vorherige Ankündigung, z. B. von Form und Aussehen, vor.

KEES VAN DER SPEK
TUINMACHINES ★ STOLWIJK

WAS IST WAS?

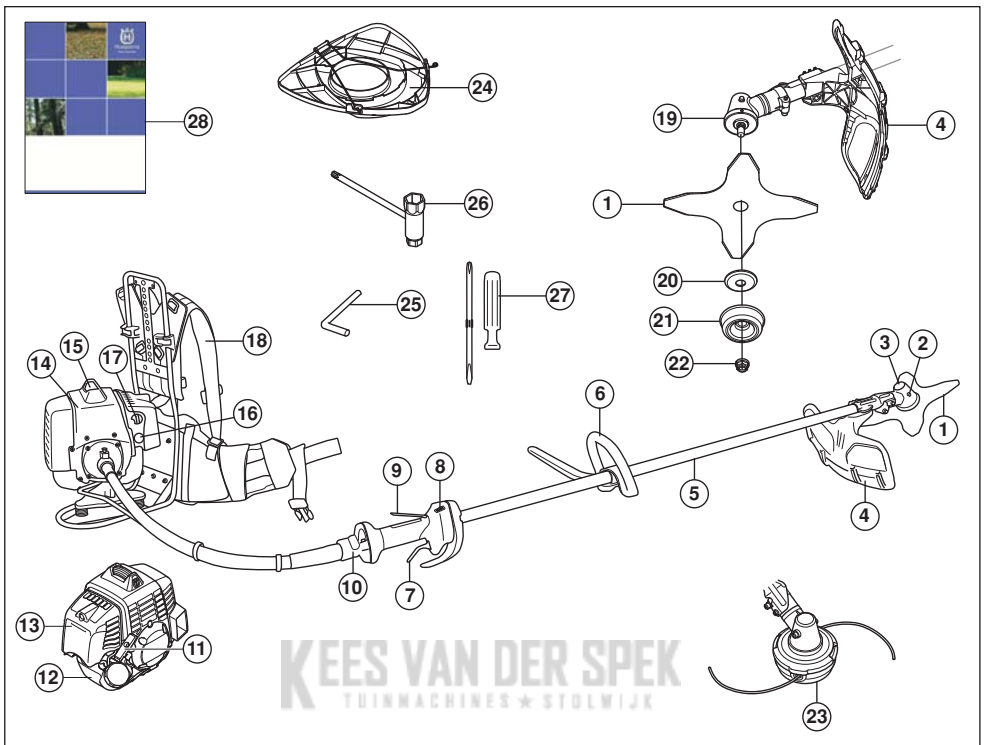

Was ist was am Freischneider?

- | | |
|--|------------------------------------|
| 1 Klinge | 15 Zündkappe und Zündkerze |
| 2 Einfüllöffnung für Schmiermittel, winkelgetriebe | 16 Kraftstoffpumpe. |
| 3 Winkelgetriebe | 17 Choke |
| 4 Schutz für die Schneidausrüstung | 18 Tragegurt |
| 5 Führungsrohr | 19 Mitnehmer |
| 6 Loophandgriff | 20 Stützflansch |
| 7 Gashebel | 21 Stützkappe |
| 8 Stoppschalter | 22 Gegenmutter |
| 9 Gashebelsperre | 23 Trimmerkopf |
| 10 Führungsrohrverbindung | 24 Transportschutz |
| 11 Starthandgriff | 25 Sperrstift |
| 12 Kraftstofftank | 26 Schlüssel für die Klängenmutter |
| 13 Luftfiltergehäuse | 27 Schraubenzieher |
| 14 Zylinderdeckel | 28 Bedienungsanweisung |

ALLGEMEINE SICHERHEITSVORSCHRIFTEN

Wichtig

WICHTIG!

Das Gerät ist nur für das Grastrimmen und Grasfreischneiden konstruiert.

Das einzige Zubehör, für das die Motoreinheit als Antriebsquelle verwendet werden darf, sind die im Kapitel Technische Daten empfohlenen Schneidausrüstungen.

Arbeiten Sie niemals mit dem Gerät, wenn Sie müde sind, Alkohol getrunken oder Medikamente eingenommen haben, da hierdurch Sehkraft, Urteilsvermögen oder Körperkontrolle beeinträchtigt werden können.

Tragen Sie persönliche Schutzausrüstung. Siehe die Anweisungen unter der Überschrift "Persönliche Schutzausrüstung".

Niemals mit einem Gerät arbeiten, das ohne Zustimmung des Herstellers modifiziert wurde und nicht länger mit der Originalausführung übereinstimmt.

Niemals mit einem defekten Gerät arbeiten. Die Wartungs-, Kontroll- und Serviceanweisungen in dieser Bedienungsanleitung sind sorgfältig zu befolgen. Gewisse Wartungs- und Servicemaßnahmen sind von geschulten, qualifizierten Fachleuten auszuführen. Siehe die Anweisungen unter der Überschrift "Wartung".

Vor der Inbetriebnahme müssen sämtliche Abdeckungen, Schutzvorrichtungen und Griffe angebracht sein. Stellen Sie sicher, dass Zündkerzenschutz und Zündkabel unversehrt sind, um die Gefahr von elektrischen Schlägen auszuschließen.

Der Anwender des Geräts hat darauf zu achten, dass während der Arbeit keine Menschen oder Tiere näher als 15 m an herankommen. Wenn mehrere Anwender am gleichen Einsatzort tätig sind, muss der Sicherheitsabstand mindestens zwei Baumlängen, jedoch mindestens 15 Meter betragen.



WARNUNG! Diese Maschine erzeugt beim Betrieb ein elektromagnetisches Feld. Dieses Feld kann sich unter bestimmten Bedingungen auf die Funktionsweise aktiver oder passiver medizinischer Implantate auswirken. Um die Gefahr für schwere oder tödliche Verletzungen auszuschließen, sollten Personen mit einem medizinischen Implantat vor der Nutzung dieser Maschine ihren Arzt und den Hersteller des Implantats konsultieren.



WARNUNG! Einen Motor in einem geschlossenen oder schlecht belüfteten Raum laufen zu lassen, kann zum Tod durch Ersticken oder Kohlenmonoxidvergiftung führen.



WARNUNG! Niemals Kindern erlauben, das Gerät zu benutzen oder sich in seiner Nähe aufzuhalten. Da das Gerät mit einem rückfedernden Stoppschalter ausgerüstet ist und mit geringer Geschwindigkeit und Kraft am Starthandgriff gestartet werden kann, können u. U. auch kleine Kinder die Kraft aufbringen, die zum Starten erforderlich ist. Dies kann zu schweren Verletzungen führen. Daher ist stets die Zündkappe zu entfernen, wenn das Gerät ohne Aufsicht ist.

Persönliche Schutzausrüstung

WICHTIG!

Falsch oder nachlässig angewendete Freischneider, Motorsensen oder Trimmer sind gefährliche Geräte, die schwere Verletzungen oder tödliche Unfälle von Anwendern oder anderen Personen verursachen können. Es ist sehr wichtig, dass Sie den Inhalt dieser Bedienungsanleitung lesen und verstehen.

Bei der Benutzung des Gerätes muss die vorgeschriebene persönliche Schutzausrüstung angewendet werden. Die persönliche Schutzausrüstung beseitigt nicht die Unfallgefahr, begrenzt aber den Umfang der Verletzungen und Schäden. Bei der Wahl der Schutzausrüstung einen Fachhändler um Rat fragen.



WARNUNG! Bei Benutzung von Gehörschützern immer auf Warnsignale oder Zurufe achten. Den Gehörschutz immer abnehmen, sobald der Motor abgestellt ist.

HELM

Schutzhelm in Bereichen, in denen Gefahr für von oben herabfallende Gegenstände besteht



GEHÖRSCHUTZ

Ein Gehörschutz mit ausreichender Dämmwirkung ist zu tragen.



ALLGEMEINE SICHERHEITSVORSCHRIFTEN

AUGENSCHUTZ

Es ist immer ein zugelassener Augenschutz zu tragen. Bei der Benutzung eines Visiers ist auch eine zugelassene Schutzbrille zu tragen. Zugelassene Schutzbrillen sind in diesem Falle diejenigen, die die Normen ANSI Z87.1 für die USA bzw. EN 166 für EU-Länder erfüllen.



HANDSCHUHE

Handschuhe sind dann zu tragen, wenn dies notwendig ist, z. B. bei der Montage der Schneid-ausrüstung.



STIEFEL

Rutschfeste und stabile Stiefel tragen.



KLEIDUNG

Kleidung aus reißfestem Material wählen und nicht zu weite Kleidungsstücke tragen, die sich leicht im Unterholz verfangen können. Stets kräftige lange Hosen tragen. Keinen Schmuck, kurze Hosen oder Sandalen tragen und nicht barfuß gehen. Schulterlanges Haar nicht offen tragen.

ERSTE HILFE

Ein Erste-Hilfe-Set soll immer griffbereit sein.



Sicherheitsausrüstung des Gerätes

In diesem Abschnitt werden einzelnen Teile der Sicherheitsausrüstung des Gerätes beschrieben, welche Funktion sie haben und wie ihre Kontrolle und Wartung ausgeführt werden sollen, um sicherzustellen, dass sie funktionsfähig sind. (Siehe Kapitel Was ist was? um herauszufinden, wo die Sicherheitsdetails an Ihrem Gerät zu finden sind).

Die Lebensdauer der Maschine kann verkürzt werden und die Unfallgefahr kann steigen, wenn die Wartung der Maschine nicht ordnungsgemäß und Service und/oder

Reparaturen nicht fachmännisch ausgeführt werden. Weitere Informationen erteilt Ihnen gerne die nächste Servicewerkstatt.

WICHTIG! Service und Reparatur des Gerätes erfordern eine Spezialausbildung. Dies gilt besonders für die Sicherheitsausrüstung des Gerätes. Wenn Ihr Gerät den unten aufgeführten Kontrollanforderungen nicht entspricht, müssen Sie Ihre Servicewerkstatt aufsuchen. Beim Kauf eines unserer Produkte wird gewährleistet, dass Reparatur- oder Servicearbeiten fachmännisch ausgeführt werden. Sollte der Verkäufer Ihres Gerätes nicht an unser Fachhändler-Service-Netz angeschlossen sein, fragen Sie nach unserer nächstgelegenen Servicewerkstatt.



WARNUNG! Benutzen Sie nie ein Gerät mit defekter Sicherheitsausrüstung. Die Sicherheitsausrüstung des Gerätes muss so kontrolliert und gewartet werden, wie dies in diesem Abschnitt beschrieben wird. Wenn Ihr Gerät den Kontrollanforderungen nicht entspricht, muss eine Servicewerkstatt aufgesucht werden.

Gashebelsperre

Die Gashebelsperre soll die unbeabsichtigte Betätigung des Gashebels verhindern. Durch Drücken der Sperre (A) im Handgriff (= wenn man den Handgriff hält) wird der Gashebel (B) gelöst. Wird der Handgriff losgelassen, werden Gashebel und Gashebelsperre wieder in ihre Ausgangsstellung zurückgestellt. Dies geschieht mit Hilfe von zwei voneinander unabhängigen Rückzugfedersystemen. In dieser Stellung wird der Gashebel im Leerlauf automatisch gesichert.

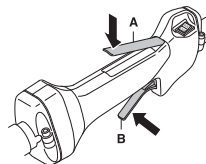

Kontrollieren, ob der Gashebel in Leerlaufstellung gesichert ist, wenn sich die Gashebelsperre in Ausgangsstellung befindet.

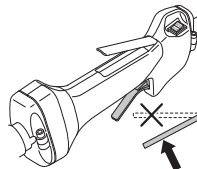

ALLGEMEINE SICHERHEITSVORSCHRIFTEN

Die Gashebelsperre eindrücken und kontrollieren, ob sie in die Ausgangsstellung zurückkehrt, wenn sie losgelassen wird.

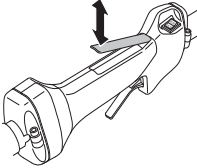

Kontrollieren, ob Gashebel und Gashebelsperre mit dem dazugehörigen Rückzugfedersystem leicht funktionieren.

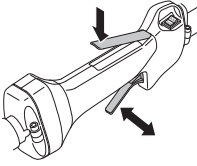

Siehe die Anweisungen unter der Überschrift Start. Gerät starten und Vollgas geben. Den Gashebel loslassen und kontrollieren, ob die Schneidausrüstung völlig zum Stillstand kommt. Wenn die Schneidausrüstung rotiert, während sich der Gashebel in Leerlaufstellung befindet, ist die LeerlaufEinstellung des Vergasers zu kontrollieren. Siehe die Anweisungen unter der Überschrift Wartung.

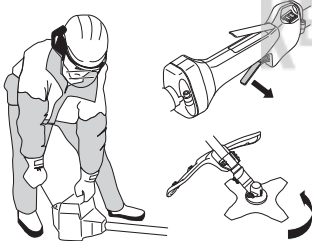

Stopschalter

Mit dem Stopschalter wird der Motor abgestellt.

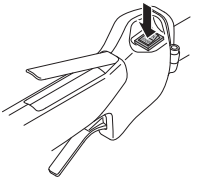

Den Motor starten und kontrollieren, ob der Motor stoppt, wenn der Stopschalter in Stoppstellung geführt wird.

Schutz für die Schneidausrüstung

Dieser Schutz soll verhindern, dass lose Gegenstände zum Anwender hochgeschleudert werden. Der Schutz

verhindert auch, dass der Anwender mit der Schneidausrüstung in Berührung kommt.

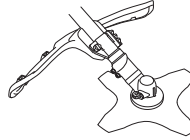

Den Schutz auf Schäden und Risse kontrollieren. Den Schutz austauschen, wenn er Schlägen ausgesetzt war oder Risse aufweist.

Immer den empfohlenen Schutz für die jeweilige Schneidausrüstung verwenden. Siehe das Kapitel Technische Daten.



WARNUNG! Unter keinen Umständen darf eine Schneidausrüstung ohne einen zugelassenen Schutz betrieben werden. Siehe das Kapitel Technische Daten. Wenn ein falscher oder ein defekter Schutz montiert wird, können dadurch schwere Verletzungen verursacht werden.

Antivibrationssystem

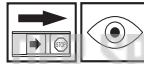

Das Gerät ist mit einem Antivibrationssystem ausgerüstet, das die Vibrationen wirkungsvoll dämpft und so für angenehmere Arbeitsbedingungen sorgt.

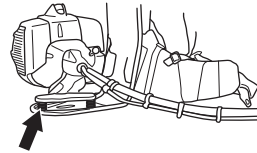

Die Verwendung eines falsch gewickelten Fadens oder einer stumpfen, falschen Schneidausrüstung (falscher Typ oder falsch gefeilt, siehe die Anweisungen unter der Überschrift Feilen der Klinge) verstärkt die Vibrationen.

Das Antivibrationssystem reduziert die Übertragung von Vibrationen zwischen Motoreinheit/Schneidausrüstung und dem Handgriffsystem des Gerätes.

Die Antivibrationselemente regelmäßig auf Risse und Verformungen überprüfen. Kontrollieren, ob die Vibrationsdämpfer unbeschädigt und fest verankert sind.

ALLGEMEINE SICHERHEITSVORSCHRIFTEN



WARNUNG! Personen mit Blutkreislaufstörungen, die zu oft Vibrationen ausgesetzt werden, laufen Gefahr, Schäden an den Blutgefäßen oder am Nervensystem davonzutragen. Gehen Sie zum Arzt, wenn Sie an Ihrem Körper Symptome feststellen, die auf Vibrationsschäden deuten. Beispiele solcher Symptome sind: Einschlafen von Körperteilen, Gefühlsverlust, Jucken, Stechen, Schmerz, Verlust oder Beeinträchtigung der normalen Körperkraft, Veränderungen der Hautfarbe oder der Haut. Diese Symptome treten am häufigsten in den Fingern, Händen oder Handgelenken auf. Bei niedrigen Temperaturen kann erhöhte Gefahr bestehen.

Schalldämpfer

Der Schalldämpfer soll den Geräuschpegel so weit wie möglich senken und die Abgase des Motors vom Anwender fernhalten. Mit Katalysator ausgestattete Schalldämpfer reduzieren zudem den Schadstoffgehalt der Abgase.

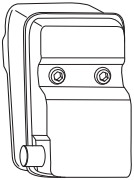

Niemals ein Gerät mit defektem Schalldämpfer benutzen.

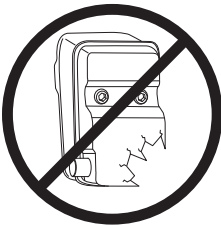

Regelmäßig kontrollieren, ob der Schalldämpfer fest am Gerät montiert ist.

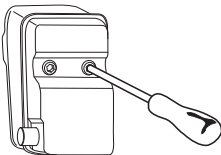

Ist der Schalldämpfer Ihres Gerätes mit einem Funkenfangnetz versehen, muss dieses regelmäßig gereinigt werden. Ein verstopftes Netz verursacht ein Heißlaufen des Motors mit schweren Motorschäden als Folge.



WARNUNG! Der Katalysatorschalldämpfer ist bei Betrieb und auch noch nach dem Ausschalten sehr heiß. Dies gilt auch für den Leerlaufbetrieb. Berühren kann zu Verbrennungen führen. Achten Sie auf die Feuergefahr!



WARNUNG! Der Schalldämpfer enthält Chemikalien, die karzinogen sein können. Falls der Schalldämpfer beschädigt wird, vermeiden Sie es, mit diesen Stoffen in Berührung zu kommen.



WARNUNG! Denken Sie daran: Die Motorabgase sind heiß und können Funken enthalten, die einen Brand verursachen können. Aus diesem Grunde sollte das Gerät niemals im Innenbereich oder in der Nähe von feuergefährlichen Stoffen gestartet werden!

Gegenmutter

Bestimmte Schneidausrüstungen sind mit einer Gegenmutter gesichert.



Bei der Montage die Mutter entgegen der Rotationsrichtung der Schneidausrüstung anziehen. Bei der Demontage die Mutter in der Rotationsrichtung der Schneidausrüstung lösen. (ACHTUNG! Die Mutter hat ein Linksgewinde.) Die Mutter mit dem Schlüssel für die Klingenmutter anziehen.

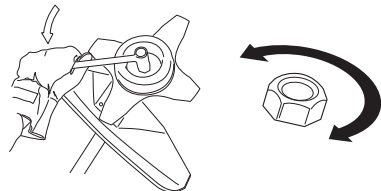

Die Nylonsicherung der Mutter darf nicht so abgenutzt sein, dass sie sich von Hand schrauben lässt. Die Sicherung soll mindestens 1,5 Nm halten. Nachdem sie ca. 10 Mal aufgeschraubt worden ist, ist die Mutter auszutauschen.

ALLGEMEINE SICHERHEITSVORSCHRIFTEN

Tragegurt



Den Tragegurt auf Beschädigungen überprüfen.

Befreien Sie sich in einer Notfallsituation von Gerät und Gurtwerk. Gehen Sie dabei wie folgt vor:

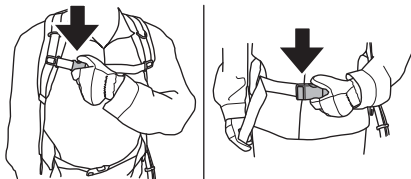

Schneidrüstung

Dieser Abschnitt beschreibt, wie man durch vorschriftsmäßige Wartung und Anwendung der richtigen Schneidrüstung:

- Verringert die Rückschlagneigung des Gerätes.
- Erreicht eine maximale Schneidleistung.
- Verlängert die Lebensdauer der Schneidrüstung.

WICHTIG!

Die Schneidrüstung immer nur mit dem von uns empfohlenen Schutz verwenden! Siehe Kapitel Technische Daten.

Zum korrekten Einlegen des Fadens und zur Wahl des richtigen Fadendurchmessers siehe die Anweisungen für die Schneidrüstung.

Die Schneidzähne der Klinge sollen stets korrekt und gut geschärft sein! Befolgen Sie unsere Empfehlungen. Beachten Sie auch die Anweisungen auf der Klingerverpackung.



WARNUNG! Den Motor immer abstellen, bevor irgendwelche Arbeiten an der Schneidrüstung ausgeführt werden. Diese rotiert noch weiter, nachdem der Gashebel losgelassen wurde. Kontrollieren, ob die Schneidrüstung völlig stillsteht, und das Kabel von der Zündkerze abziehen, bevor mit der Arbeit an der Schneidrüstung begonnen wird.



WARNUNG! Durch eine falsche Schneidrüstung oder eine falsch gefeilte Klinge erhöht sich die Rückschlaggefahr.

Schneidrüstung

Grasklinge und Grasmesser sind für das Mähen von dichtem hohen Gras vorgesehen.

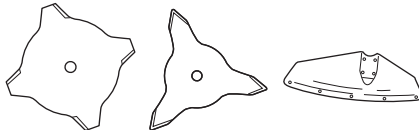

Der Trimmerkopf dient zum Rasentrimmen.



Grundregeln



Die Schneidrüstung immer nur mit dem von uns empfohlenen Schutz verwenden! Siehe Kapitel Technische Daten.

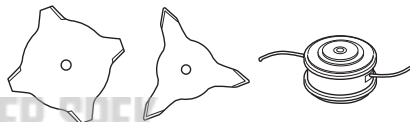

Die Schneidzähne der Klinge sollen stets korrekt und gut geschärft sein! Befolgen Sie unsere Anleitung und verwenden Sie die empfohlene Schärfllehre. Eine falsch geschärfte oder beschädigte Klinge erhöht die Unfallgefahr.

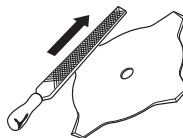

Die Schneidrüstung auf Beschädigung und Risse kontrollieren. Beschädigte Schneidrüstungen sind grundsätzlich auszutauschen.

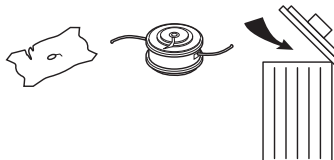

ALLGEMEINE SICHERHEITSVORSCHRIFTEN

Feilen von Grasmesser und Grasklinge



- Befolgen Sie die Feilanleitung auf der Verpackung der Schneidausrüstung. Klinge und Messer werden mit einer einhiebigen Flachfeile gefeilt.
- Alle Schneiden gleichmäßig feilen, damit keine Unwucht entsteht.

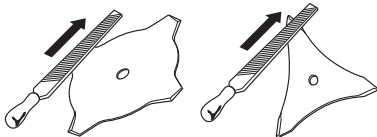

WARNUNG! Eine Klinge, die verbogen, schief, gerissen, gebrochen oder auf andere Art beschädigt ist, immer aussortieren. Niemals versuchen, eine schiefe Klinge zur weiteren Anwendung wieder zu richten. Ausschließlich Originalklingen des vorgeschriebenen Typs verwenden.

Trimmerkopf

WICHTIG!

Stets darauf achten, dass der Trimmerfaden fest und gleichmäßig auf die Rolle gewickelt wird, andernfalls entstehen im Gerät gesundheitsschädliche Vibrationen.

- Nur die empfohlenen Trimmerköpfe und Fäden verwenden. Sie sind vom Hersteller für eine bestimmte Motorgröße getestet worden. Dies ist besonders wichtig, wenn ein vollautomatischer Trimmerkopf verwendet wird. Benutzen Sie nur die empfohlene Schneidausrüstung. Siehe das Kapitel Technische Daten.



- Im Allgemeinen erfordert ein kleineres Gerät kleine Trimmerköpfe und umgekehrt. Der Grund hierfür ist, dass der Motor beim Mähen mit Faden diesen radial vom Trimmerkopf herausschleudern und dabei auch den Widerstand des zu mähenden Grases überwinden muss.
- Die Länge des Fadens ist ebenfalls wichtig. Beim gleichen Fadendurchmesser erfordert ein längerer Faden eine größere Motorleistung als ein kurzer.
- Darauf achten, dass das Messer am Trimmerschutz intakt ist. Es dient dazu, den Faden auf die richtige Länge zu schneiden.

- Die Lebensdauer des Fadens lässt sich verlängern, indem man ihn für ein paar Tage in Wasser legt. Dadurch wird der Faden steifer und hält länger.

MONTAGE

Montage der flexiblen Antriebswelle



- Die beiden Schrauben an der Führungsrohrverbindung lösen.

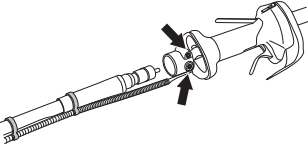

- Biegewelle durch die Kabelschleifen schieben und an der Führungsrohrverbindung befestigen. Biegewelle gleichzeitig drehen und drücken, damit diese richtig sitzt.
- Die zwei Schrauben anziehen.
- Den Antriebswellenmantel so in den Kupplungsdeckel montieren, dass das Loch mitten unter dem Sperrknopf am Kupplungsdeckel liegt.

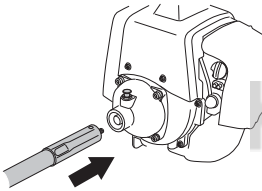

- Biegewelle gleichzeitig drehen und drücken, damit diese richtig sitzt.
- Sicherstellen, dass der Sperrstift in die ursprüngliche Position gebracht wird, sodass die Hülse der Antriebswelle nicht aus dem Kupplungsgehäuse herausrutscht.

Beschleunigungskabel und Ein-/Ausschalterdraht anschließen



- Gaszug aus der Verkabelung (A) und Gaszug aus dem Motor (B) wie abgebildet in die Kunststoffhülse schieben.

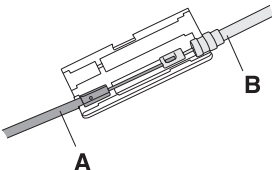

- Kunststoffhülse schließen.

- Stoppschalterdrähte an die passenden Steckverbinder vom Motor anschließen. Die Kabelpolarität ist nicht wichtig.

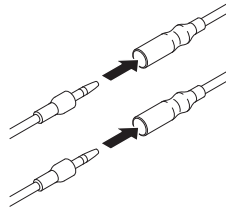

Montage des J-Handgriffs



- Den Handgriff auf das Führungsrohr setzen. Bitte beachten, dass der Handgriff unterhalb der Pfeilmarkierung am Führungsrohr montiert werden muss.

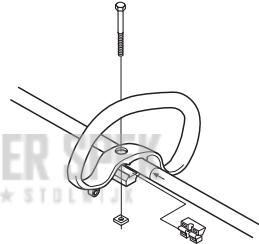

- Den Abstandhalter in die Führung im Loophandgriff schieben.
- Mutter und Schraube montieren. Nicht zu fest anziehen.
- Den J-Handgriff gem. Abbildung mit drei Schrauben am Loophandgriff montieren.

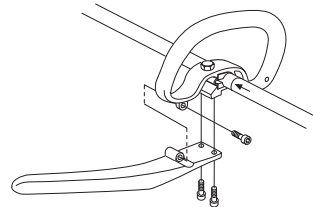

- Nun eine Feineinstellung vornehmen, so dass sich mit dem Trimmer eine bequeme Arbeitshaltung ergibt. Dann die Schraube/den Drehknopf fest anziehen.

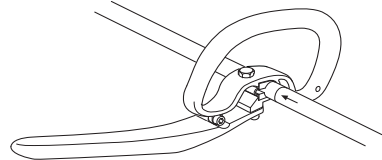

MONTAGE



WARNUNG! Wenn der J-Handgriff montiert ist, dürfen nur Grasklingen/Grasmesser oder Trimmerköpfe/Kunststoffmesser verwendet werden. Zusammen mit dem J-Handgriff niemals eine Sägeklinge verwenden.

Montage von Klinge und Trimmerkopf



WARNUNG! Bei der Montage der Schneidausrüstung ist es äußerst wichtig, dass die Führung des Mitnehmers/Stützflansches korrekt im Zentrumloch der Schneidausrüstung sitzt. Eine falsch montierte Schneidausrüstung kann schwere oder gar lebensgefährliche Verletzungen verursachen.

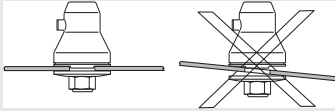

WARNUNG! Unter keinen Umständen darf eine Schneidausrüstung ohne einen zugelassenen Schutz betrieben werden. Siehe das Kapitel Technische Daten. Wenn ein falscher oder ein defekter Schutz montiert wird, können dadurch schwere Verletzungen verursacht werden.

WICHTIG! Um eine Säge- oder Grasklinge benutzen zu dürfen, muss das Gerät mit dem richtigen Lenker, Klingenschutz und Tragegurt ausgerüstet sein.

Montage der Schutzabdeckung



ACHTUNG! Bei Verwendung von Trimmerkopf/Kunststoffmessern und Kombischutz muss die Schutzabdeckung stets montiert sein. Bei Verwendung von Grasklinge und Kombischutz muss die Schutzabdeckung demontiert sein.

Den Klingenschutz/Kombischutz (A) an seiner Halterung am Führungsrohr einhaken und mit einer Schraube fixieren.

Die Schutzkappenführung in die Nut am Kombischutz einsetzen. Anschließend die Schutzabdeckung mithilfe

der vier Schnellspannvorrichtungen am Schutz befestigen.

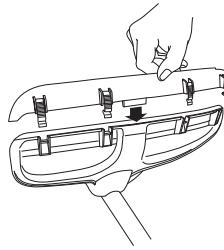

Die Demontage der Schutzabdeckung lässt sich am einfachsten mit einem Schraubendreher bewerkstelligen (siehe Abb.).

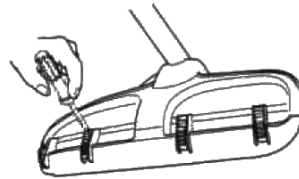

Montage von Klingenschutz, Grasklinge und Grasmesser



- Den Klingenschutz/Kombischutz (A) an seiner Halterung am Führungsrohr einhaken und mit einer Schraube fixieren (L). Den empfohlenen Klingenschutz verwenden. Siehe das Kapitel Technische Daten. **ACHTUNG!** Dafür sorgen, dass die Schutzabdeckung demontiert ist.

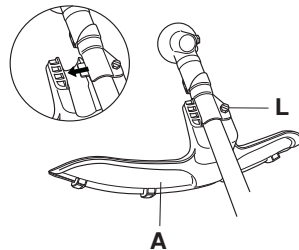

- Mitnehmer (B) an der Abtriebswelle montieren.
- Die Klingennachse drehen, bis sich eines der Löcher des Mitnehmers mit dem entsprechenden Loch im Getriebegehäuse deckt.
- Den Sperrstift (C) in das Loch stecken, so dass die Achse fixiert ist.
- Klinge (D), Stützkappe (E) und Stützflansch (F) an der Abtriebswelle montieren.
- Die Mutter (G) montieren. Die Mutter ist mit einem Moment von 35-50 Nm (3,5-5 kpm) anzuziehen. Den

MONTAGE

Hülsenschlüssel aus dem Werkzeugsatz verwenden. Den Schaft des Schlüssels so nah wie möglich am Klingenschutz greifen. Die Mutter wird angezogen, wenn der Schlüssel entgegen der Rotationsrichtung geführt wird (Achtung: Linksgewinde).

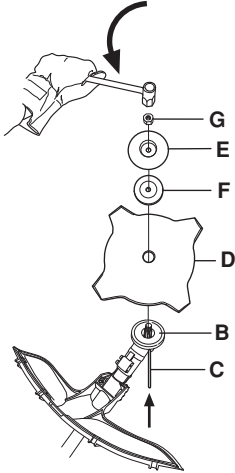

Montage von Trimmerschutz und Trimmerkopf



- Für die Arbeit mit dem Trimmerkopf den Trimmerschutz (A) montieren. ACHTUNG! Dafür sorgen, dass die Schutzabdeckung montiert ist.

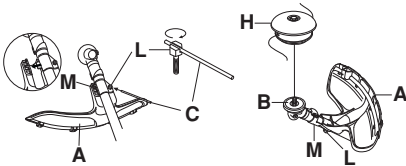

- Den Trimmerschutz/Kombischutz an der Halterung am Führungsrohr einhaken und mit einer Schraube (L) fixieren.
- Mitnehmer (B) an der Abtriebswelle montieren.
- Die Klingennachse drehen, bis sich eines der Löcher des Mitnehmers mit dem entsprechenden Loch im Getriebegehäuse deckt.
- Den Sperrstift (C) in das Loch stecken, so dass die Achse fixiert ist.

- Den Trimmerkopf/die Kunststoffmesser (H) entgegen der Rotationsrichtung aufschrauben.

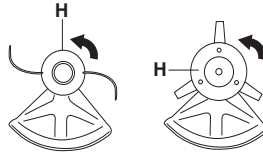

- Die Demontage erfolgt in umgekehrter Reihenfolge.

Montage des Transportschutzes



- Setzen Sie das Sägeblatt in den Transportschutz (A) ein.
- Schieben Sie die beiden Halterungen (B) bis zum Einrasten in die Schlitze (C) ein, um den Transportschutz zu fixieren.

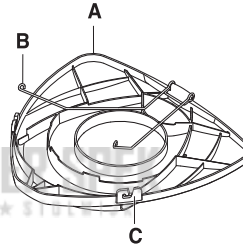

Anpassung von Tragegurt und Freischneider



Einstellen der Höhe der Rückplatte

- Die beiden Drehknöpfe an der Rückplatte lösen.

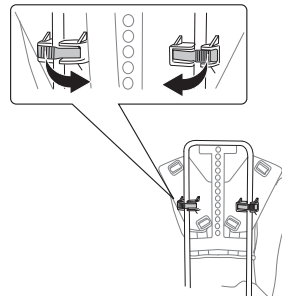

MONTAGE

- Die Rückplatte an einer Seite vom Rahmen lösen.

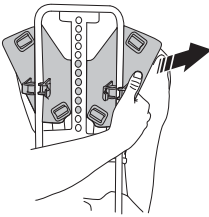

- Die Rückplatte auf die gewünschte Höhe einstellen und festziehen. Vergewissern Sie sich, dass der Stift durch eines der Löcher am Rahmen geführt wird (siehe Abbildung).

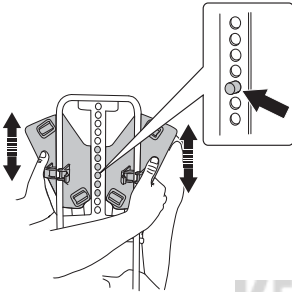

Einstellung des Gurtes

- Den Tragegurt anlegen.
- Den Taillengurt so spannen, dass er fest sitzt.



- Den Brustgurt festziehen.



- Den Brustgurt bei Bedarf senkrecht einstellen und darauf achten, dass dieser passend eingestellt ist.

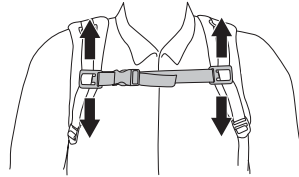

- Die Schulterriemen so einstellen, dass die Schultern gleichmäßig belastet werden.



- Lockern oder ziehen Sie den Taillengurt fest, sodass ca. 70 % der Last auf Ihrer Taille und 30 % auf Ihren Schultern lasten.

KEES VAN DER SPEK
TUINMACHINES * STOLWIJK

UMGANG MIT KRAFTSTOFF

Sicherer Umgang mit Kraftstoff

Das Gerät niemals starten, wenn:

- 1 Wenn Kraftstoff darüber verschüttet wurde. Alles abwischen und restliches Benzin verdunsten lassen.
- 2 Wenn Sie Kraftstoff über sich selbst oder Ihre Kleidung verschüttet haben, ziehen Sie sich um. Waschen Sie die Körperteile, die mit dem Kraftstoff in Berührung gekommen sind. Wasser und Seife verwenden.
- 3 Wenn es Kraftstoff leckt. Tankdeckel und Tankleitungen regelmäßig auf Undichtigkeiten überprüfen.

Transport und Aufbewahrung

- Das Gerät und den Kraftstoff so transportieren und aufbewahren, dass bei eventuellen Undichtigkeiten entweichende Dämpfe oder Kraftstoff nicht mit Funken oder offenem Feuer in Kontakt kommen können, z. B. von Elektrogeräten, Elektromotoren, elektrischen Kontakten/Schaltern oder Heizkesseln.
- Zum Transport und zur Aufbewahrung von Kraftstoff sind speziell für diesen Zweck vorgesehene und zugelassene Behälter zu verwenden.
- Bei längerer Aufbewahrung des Geräts ist der Kraftstofftank zu leeren. An der nächsten Tankstelle können Sie erfahren, wie Sie überschüssigen Kraftstoff am besten entsorgen.
- Vor der Langzeitaufbewahrung sicherstellen, dass die Maschine gründlich gesäubert und komplett gewartet wurde.
- Bei Transport oder Aufbewahrung des Gerätes muss der Transportschutz für die Schneidusrüstung immer montiert sein.
- Sichern Sie die Maschine während des Transports.



WARNUNG! Beim Umgang mit Kraftstoff vorsichtig sein. Denken Sie an das Feuer- und Explosionsrisiko und an die Gefahr des Einatmens.

Kraftstoff

ACHTUNG! Das Gerät ist mit einem Zweitaktmotor ausgestattet und daher ausschließlich mit einer Mischung aus Benzin und Zweitaktöl zu betreiben. Damit das Mischungsverhältnis richtig ist, muss die beizumischende Ölmenge unbedingt genau abgemessen werden. Wenn kleine Kraftstoffmengen gemischt werden, wirken sich auch kleine Abweichungen bei der Ölmenge stark auf das Mischungsverhältnis aus.



WARNUNG! Kraftstoff und Kraftstoffdämpfe sind sehr feuergefährlich und können beim Einatmen und auf der Haut schwere Schäden verursachen. Beim Umgang mit Kraftstoff ist daher Vorsicht geboten und für eine gute Belüftung zu sorgen.

Benzin



ACHTUNG! Stets Qualitätsbenzin mit Ölbeimischung mit mind. 90 Oktan (ROZ) verwenden. Wenn Ihr Gerät mit Katalysator ausgestattet ist (siehe Kapitel Technische Daten), muss stets bleifreies Qualitätsbenzin mit Ölbeimischung verwendet werden. Verbleites Benzin zerstört den Katalysator.

Wenn umweltgerechtes sog. Alkylatbenzin zur Verfügung steht, ist dieses zu verwenden.

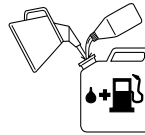

- Als niedrigste Oktanzahl wird ROZ 90 empfohlen. Wenn der Motor mit Benzin einer niedrigeren Oktanzahl als 90 betrieben wird, läuft er nicht einwandfrei. Das führt zu erhöhten Motortemperaturen, die schwere Motorschäden verursachen können.
- Wenn kontinuierlich bei hohen Drehzahlen gearbeitet wird, ist eine höhere Oktanzahl zu empfehlen.

Zweitaktöl

- Das beste Resultat und die beste Leistung wird mit HUSQVARNA-Zweitaktmotoröl erzielt, das speziell für unsere luftgekühlten Zweitaktmotoren hergestellt wird.
- Niemals Zweitaktöl für wassergekühlte Außenbordmotoren, sog. Outboardoil (TCW), verwenden.
- Niemals Öl für Viertaktmotoren verwenden.
- Eine unzureichende Ölqualität oder ein zu fettes Öl/ Kraftstoff-Gemisch kann die Funktion des Katalysators beeinträchtigen und seine Lebensdauer reduzieren.
- Mischungsverhältnis
1:50 (2 %) mit HUSQVARNA-Zweitaktöl.
1:33 (3 %) mit anderen Ölen für luftgekühlte Zweitaktmotoren der Klasse JASO FB/ISO EGB.

UMGANG MIT KRAFTSTOFF

Benzin, Liter	Zweitaktöl, Liter	
	2% (1:50)	3% (1:33)
5	0,10	0,15
10	0,20	0,30
15	0,30	0,45
20	0,40	0,60

Mischen

- Benzin und Öl stets in einem sauberen, für Benzin zugelassenen Behälter mischen.
- Immer zuerst die Hälfte des Benzins, das gemischt werden soll, einfüllen. Danach die gesamte Ölmenge einfüllen. Die Kraftstoffmischung mischen (schütteln). Dann den Rest des Benzins dazugeben.
- Vor dem Einfüllen in den Tank der Maschine die Kraftstoffmischung noch einmal sorgfältig mischen (schütteln).



- Kraftstoff höchstens für einen Monat im Voraus mischen.
- Wenn das Gerät über einen längeren Zeitraum nicht benutzt wird, den Kraftstofftank entleeren und reinigen.



WARNUNG! Der Schalldämpfer des Katalysators ist sehr heiß, sowohl beim Betrieb als auch nach dem Abstellen. Dies gilt auch bei Leerlaufbetrieb. Die Brandgefahr beachten, besonders wenn sich feuergefährliche Stoffe und/oder Gase in der Nähe befinden.

Tanken



WARNUNG! Folgende Vorsichtsmaßnahmen verringern die Feuergefahr:

Beim Tanken nicht rauchen und jegliche Wärmequellen vom Kraftstoff fernhalten.

Niemals bei laufendem Motor tanken.

Den Motor abstellen und vor dem Tanken einige Minuten abkühlen lassen.

Den Tankdeckel stets vorsichtig öffnen, so dass sich ein evtl. vorhandener Überdruck langsam abbauen kann.

Den Tankdeckel nach dem Tanken wieder sorgfältig zudrehen.

Die Maschine vor dem Start immer aus dem Auftankbereich und von der Auftankquelle weg bewegen.

- Verwenden Sie einen Kraftstoffbehälter mit Überfüllungsschutz.
- Um den Tankdeckel herum sauberwischen. Verunreinigungen im Tank verursachen Betriebsstörungen.
- Vor dem Einfüllen in den Tank den Behälter noch einmal schütteln, damit der Kraftstoff gut gemischt ist.



STARTEN UND STOPPEN

Kontrolle vor dem Start



- Das Gerät niemals ohne Schutz oder mit defektem Schutz benutzen.
- Vor dem Start des Geräts müssen sämtliche Gehäuse korrekt montiert und in einwandfreiem Zustand sein.
- Die Klinge auf Risse am Zahnansatz und um das Mittelloch herum kontrollieren. Die häufigste Ursache für Rissbildungen am Zahnansatz stellen beim Feilen entstandene scharfe Ecken oder die Anwendung der Klinge in stumpfem Zustand dar. Die Klinge austauschen, wenn sie Risse aufweist.

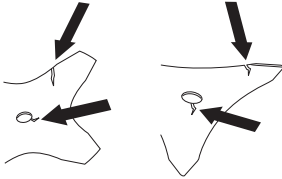

- Den Stützflansch auf Risse hin untersuchen, die aufgrund von Materialermüdung oder zu festem Anziehen entstehen können. Den Stützflansch austauschen, wenn er Risse aufweist.

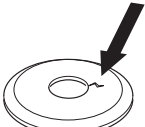

- Darauf achten, dass die Gegenmutter ihre Schließkraft nicht verliert. Sie soll ein Schließmoment von mind. 1,5 Nm haben. Das Anziehmoment der Gegenmutter soll 35-50 Nm betragen.



- Den Klingenschutz auf Schäden und Risse kontrollieren. Den Klingenschutz austauschen, wenn er Risse hat oder Schlägen ausgesetzt gewesen ist.

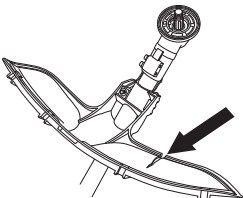

- Trimmerkopf und Trimmerschutz auf Schäden und Risse kontrollieren. Wenn Trimmerkopf oder Trimmerschutz Risse haben oder Schlägen

ausgesetzt gewesen sind, müssen sie ausgetauscht werden.

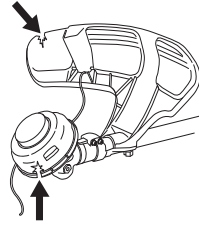

Starten und stoppen



WARNUNG! Das komplette Kupplungsgehäuse und das Führungsrohr müssen montiert sein, bevor das Gerät gestartet wird, andernfalls kann sich die Kupplung lösen und Verletzungen verursachen.

Die Maschine vor dem Start immer aus dem Auftankbereich und von der Auftankquelle weg bewegen. Das Gerät auf festem Untergrund abstellen. Darauf achten, dass die Schneidausrüstung keine Gegenstände berührt.

Sorgen Sie dafür, dass sich innerhalb des Arbeitsbereichs keine unbefugten Personen aufhalten, andernfalls besteht die Gefahr von schweren Verletzungen. Der Sicherheitsabstand beträgt 15 Meter.

Starten



Zündung: Den Stoppschalter in Startposition stellen.

Kraftstoffpumpe: Mehrmals auf die Gummiblase der Kraftstoffpumpe drücken, bis diese sich mit Kraftstoff zu

STARTEN UND STOPPEN

füllen beginnt. Die Blase braucht nicht ganz gefüllt zu werden.

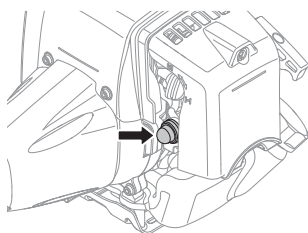

Choke: Den Chokehebel in Choke-Lage führen.

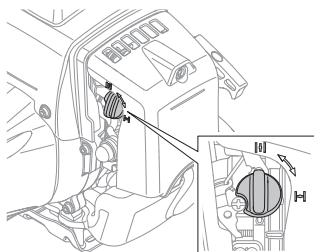

WARNING! Wenn der Chokehebel beim Starten des Motors auf Choke oder Startgas eingestellt ist, fängt die Schneidausrüstung sofort an zu rotieren.

Den Gerätekörper mit der linken Hand gegen den Boden drücken (ACHTUNG! Nicht mit dem Fuß!). Mit der rechten Hand den Starthandgriff fassen und das Startseil langsam herausziehen, bis ein Widerstand spürbar wird (die Starthaken greifen), und dann schnell und kräftig ziehen. **Das Startseil niemals um die Hand wickeln.**

Den Choke sofort rückstellen, wenn der Motor zündet, und weitere Startversuche machen, bis der Motor anspringt. Wenn der Motor startet, schnell Vollgas geben, wodurch das Startgas automatisch ausgeschaltet wird.

ACHTUNG! Das Startseil nicht ganz herausziehen und den Startgriff aus ganz herausgezogener Lage nicht loslassen. Schäden am Gerät könnten die Folge sein.

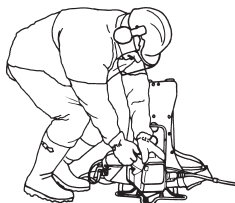

ACHTUNG! Kein Körperteil darf auf die markierte Fläche geraten. Der Kontakt kann zu Hautverbrennungen oder elektrischen Schlägen führen, wenn die Zündkappe

defekt ist. Stets Handschuhe tragen. Niemals eine Maschine mit defekter Zündkappe verwenden.

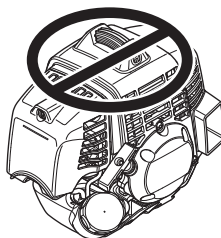

Stoppen



Zum Abstellen des Motors die Zündung ausschalten.

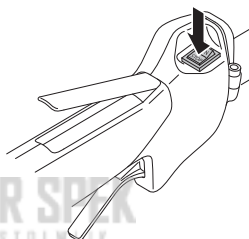

Allgemeine Arbeitsvorschriften

WICHTIG!

Dieser Abschnitt behandelt grundlegende Sicherheitsregeln für die Arbeit mit Freischneider und Trimmer.

Wenn Sie in eine Situation kommen, die Sie in Bezug auf die weitere Anwendung des Geräts verunsichert, lassen Sie sich von einem Experten beraten. Wenden Sie sich an Ihren Fachhändler oder Ihre Servicewerkstatt.

Vermeiden Sie, Arbeiten auszuführen, denen Sie sich nicht gewachsen fühlen.

Vor der Anwendung müssen Sie den Unterschied zwischen Forstfreischneiden, Grasfreischneiden und Grastrimmen verstehen.

unvermittelt Ihren Standort wechseln. Beim Arbeiten auf abschüssigem Boden immer sehr vorsichtig sein.



- 5 Tragen Sie dieses rückentragbare Laubblasgerät während des Betriebs immer anhand eines Gurtes auf den Schultern.
- 6 Eine sichere Arbeitsstellung mit festen Stand einnehmen.
- 7 Die Maschine stets mit beiden Händen halten.
- 8 Die Schneidausrüstung muss sich unterhalb der Taille befinden.
- 9 Beim Weitergehen ist der Motor abzustellen. Bei längeren Wegstrecken und Transporten ist der Transportschutz anzuwenden.
- 10 Das Gerät niemals mit laufendem Motor unbeaufsichtigt abstellen.

Grundlegende Sicherheitsvorschriften



- 1 Behalten Sie die Umgebung im Auge:
 - Um sicherzustellen, dass weder Menschen noch Tiere oder anderes Ihre Kontrolle über das Gerät beeinflussen können.
 - Um sicherzustellen, dass weder Menschen, Tiere noch Gegenstände Gefahr laufen, mit der Schneidausrüstung selber oder mit von der Schneidausrüstung hochgeschleuderten losen Gegenständen in Kontakt kommen.
 - **ACHTUNG!** Das Gerät niemals benutzen, wenn nicht die Möglichkeit besteht, im Falle eines Unfalls Hilfe herbeizurufen.
- 2 Den Arbeitsbereich inspizieren. Alle losen Gegenstände entfernen, z. B. Steine, Glasscherben, Nägel, Drähte, Schnüre, usw., die weggeschleudert werden oder sich in der Schneidausrüstung verfangen können.
- 3 Vermeiden Sie es, das Gerät bei schlechtem Wetter zu benutzen. Z.B. bei dichtem Nebel, starkem Regen oder Wind, großer Kälte usw. Bei schlechtem Wetter ist das Arbeiten nicht nur ermüdend, es können außerdem gefährliche Arbeitsbedingungen entstehen, z.B. glatter Boden, unberechenbare Fällrichtung des Baumes usw.
- 4 Sicherstellen, dass Sie sicher gehen und stehen können. Achten Sie auf evtl. Hindernisse (Wurzeln, Steine, Äste, Löcher, Gräben usw.), wenn Sie



WARNUNG! Weder der Benutzer der Maschine noch andere Personen dürfen versuchen, das Mähgut aufzusammeln, solange der Motor läuft oder die Schneidausrüstung rotiert, weil dadurch schwere Verletzungen verursacht werden können.

Motor und Schneidausrüstung stoppen, bevor Material entfernt wird, das sich um die Klingennachse festgesetzt hat, da ansonsten Verletzungsgefahr besteht. Während des Betriebs und eine Weile danach kann das Winkelgetriebe heiß sein. Beim Berühren besteht Verbrennungsgefahr.



WARNUNG! Vorsicht bei weggeschleuderten Gegenständen. Stets einen zugelassenen Augenschutz tragen. Niemals über den Schutz der Schneid-ausrüstung beugen. Hochgeschleuderte Steine, Unrat usw. können die Augen treffen und Blindheit oder schwere Verletzungen verursachen.

Unbefugte auf Abstand halten. Kinder, Tiere, Zuschauer und Helfer sollten sich außerhalb einer Sicherheitszone von 15 m befinden. Stellen Sie das Gerät sofort ab, wenn sich Ihnen jemand nähert. Wenden Sie sich niemals abrupt mit dem Gerät um, ohne vorher sicherzustellen, dass sich hinter Ihnen niemand innerhalb der Sicherheitszone befindet.

Grundlegende Arbeitstechnik

Nach jedem Arbeitsmoment den Motor im Leerlauf laufen lassen. Längerer Betrieb bei hoher Drehzahl ohne Belastung kann schwere Motorschäden verursachen.



WARNUNG! Manchmal setzen sich Äste oder Gras zwischen Schutz und Schneid-ausrüstung fest. Zum Reinigen grundsätzlich den Motor abstellen.



WARNUNG! Maschinen mit Säge- oder Grasklingen können heftig zur Seite geschleudert werden, wenn die Klinge auf einen festen Gegenstand trifft. Dies wird als Klingenstoß bezeichnet. Bei einem Klingenstoß kann so viel Energie freigesetzt werden, dass Maschine und bzw. oder Benutzer weggeschleudert werden und die Kontrolle über die Maschine verloren geht. Ein Klingenstoß kann auftreten, wenn die Maschine Stümpfe rodet, durch Kollisionen zum Stillstand kommt oder sich verhakt. Ein Klingenstoß tritt mit höherer Wahrscheinlichkeit in Bereichen auf, in denen das geschnittene Material nur schwer zu sehen ist.

Vermeiden Sie es, im Schneidbereich zwischen 12 und 3 Uhr an der Klinge zu sägen. Aufgrund der Rotationsgeschwindigkeit der Klinge kann ein Rückschlag gerade in diesem Ansatzbereich eintreffen, wenn die Klinge an dicke Stämme angesetzt wird.

Grasfreischneiden mit Grasklinge



- Grasklingen und Grasmesser dürfen nicht für verholzte Stämme verwendet werden.
- Für alle Arten von hohem oder dichtem Gras wird die Klinge benutzt.
- Gras wird mit einer pendelnden seitlichen Bewegung gemäht, wobei bei der Bewegung von rechts nach links gemäht wird und die Rückholbewegung von links nach rechts erfolgt. Die Klinge mit der linken Seite mähen lassen (Klingenbereich zwischen 8 und 12 Uhr).

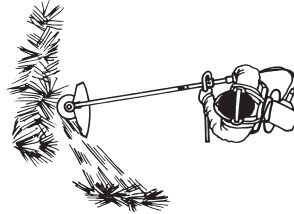

- Wird die Klinge beim Mähen etwas nach links geneigt, bleibt der Grasschnitt in einer Bahn liegen, was das Aufsammeln z. B. durch Harken erleichtert.
- Bemühen Sie sich, rhythmisch zu arbeiten. Mit gespreizten Beinen stehen Sie am sichersten. Nach der Rückholbewegung vorwärts gehen und wieder einen festen Stand suchen.
- Die Stützkappe leicht auf dem Boden abstützen. Sie dient dazu, die Klinge vor Bodenberührung zu schützen.
- Wenn Sie folgende Regeln befolgen, setzt sich das Material nicht so leicht um die Klinge herum fest:
 - 1 Arbeiten Sie stets mit Vollgas.
 - 2 Vermeiden Sie Kontakt mit frisch geschlagenem Schnittgut bei der Rückholbewegung.
- Den Motor abstellen, den Gurt abnehmen und das Gerät auf den Boden legen, bevor Sie das Schnittgut aufsammeln.

Grastrimmen mit Trimmerkopf



Trimmen

- Den Trimmerkopf direkt über die Erde halten und etwas neigen. Das Gras wird vom Fadenende abgeschnitten. Lassen Sie den Faden im eigenen Takt arbeiten. Pressen Sie den Faden nie in das Material hinein, das geschnitten werden soll.



ARBEITSTECHNIK

- Der Faden mäht mit Leichtigkeit Gras und Unkraut an Wänden, Zäunen, Bäumen und Beeten, er kann jedoch auch empfindliche Rinde von Bäumen und Büschen sowie Zaunpfähle beschädigen.
- Verringern Sie das Risiko, Vegetation zu schädigen, indem Sie den Faden auf 10-12 cm kürzen und die Motordrehzahl senken.

Sauberschaben

- Durch Sauberschaben kann unerwünschte Vegetation vollständig entfernt werden. Den Trimmerkopf direkt über die Erde halten und neigen. Das Fadenende um Bäume, Pfähle, Statuen usw. herum gegen die Erde schlagen lassen. **ACHTUNG!** Bei dieser Technik wird der Faden verstärkt abgenutzt.



- Bei der Arbeit an Steinen, Ziegeln, Beton, Metallzäunen usw. wird der Faden stärker abgenutzt und muss häufiger nachgestellt werden, als wenn er gegen Bäume oder Holzzäune schlägt.
- Beim Trimmen und Sauberschaben nicht mit Vollgas arbeiten, damit der Faden länger hält und der Trimmerkopf nicht so starkem Verschleiß ausgesetzt ist.

Mähen

- Ein Trimmer ist das optimale Gerät zum Mähen an Stellen, die mit einem gewöhnlichen Rasenmäher schwer zugänglich sind. Beim Mähen den Faden parallel zur Erde halten. Den Trimmerkopf nicht auf die Erde drücken, weil dadurch Rasen und Gerät beschädigt werden können.

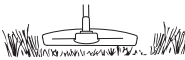

- Beim normalen Mähen sollte der Trimmerkopf nicht ständig den Boden berühren. Ständiger Kontakt kann zu erhöhtem Verschleiß oder zu Schäden am Trimmerkopf führen.

Säubern

- Die Gebläsewirkung des rotierenden Fadens kann auch zum einfachen und schnellen Säubern dienen. Den Faden parallel etwas oberhalb der Fläche halten,

die gereinigt werden soll, und das Gerät hin- und herführen.

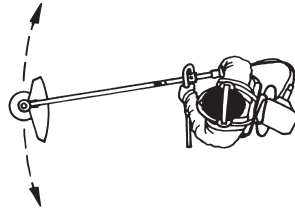

- Beim Mähen und Säubern erreicht man mit Vollgas das beste Resultat.

KEES VAN DER SPEK
TUINMACHINES * STOLWIJK

Vergaser

Einstellung des Leerlaufs (T)

Kontrollieren, ob der Luftfilter sauber ist. Wenn der Leerlauf korrekt eingestellt ist, darf die Schneidausrüstung nicht rotieren. Falls eine Einstellung notwendig ist, die T-Schraube (im Uhrzeigersinn) bei laufendem Motor schließen, bis die Schneidausrüstung zu rotieren beginnt. Dann die Schraube (gegen den Uhrzeigersinn) öffnen, bis die Schneidausrüstung stehen bleibt. Die korrekte Leerlaufdrehzahl ist eingestellt, wenn der Motor in allen Positionen gleichmäßig läuft, mit guter Spanne bis zu der Drehzahl, bei der die Schneidausrüstung zu rotieren beginnt.

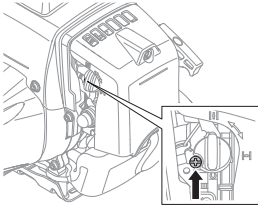

WARNUNG! Kann die Leerlaufdrehzahl nicht so eingestellt werden, dass die Schneidausrüstung stehenbleibt, wenden Sie sie an Ihren Händler/Ihre Servicewerkstatt. Das Gerät erst wieder verwenden, wenn es korrekt eingestellt oder repariert ist.

Luftfilter

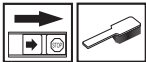

Luftfilter regelmäßig von Staub und Schmutz reinigen, zur Vermeidung von:

- Vergaserstörungen
- Startschwierigkeiten
- Leistungsminderung
- Unnötigem Verschleiß der Motorteile.
- Unnormal hohem Kraftstoffverbrauch.

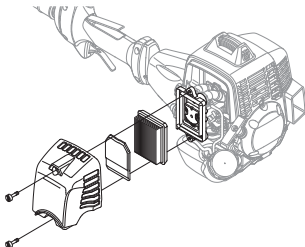

Den Filter jeweils nach 25 Betriebsstunden reinigen, bei besonders staubigen Verhältnissen häufiger.

Reinigung des Luftfilters

Das Luftfiltergehäuse demontieren und den Filter herausnehmen. Den Filter in warmer Seifenlauge waschen. Dafür sorgen, dass der Filter trocken ist, wenn er wieder montiert wird.

Ein Luftfilter, der längere Zeit verwendet wurde, wird nie vollkommen sauber. Der Luftfilter ist daher in regelmäßigen Abständen auszuwechseln. **Beschädigte Filter sind immer auszuwechseln.**

Kraftstofffilter

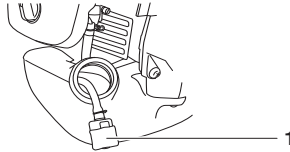

1 Kraftstofffilter

Wenn der Motor nicht ausreichend mit Kraftstoff versorgt wird, Tankdeckel und Kraftstofffilter auf Verstopfungen überprüfen.

Winkelgetriebe



Das Winkelgetriebe ist ab Werk mit der richtigen Menge Fett gefüllt. Bevor das Gerät in Betrieb genommen wird, sollte jedoch kontrolliert werden, ob das Getriebe zu 3/4 mit Fett gefüllt ist. HUSQVARNA Spezialfett verwenden.

Das Schmiermittel im Getriebegehäuse braucht normalerweise nur bei evtl. Reparaturen gewechselt zu werden.

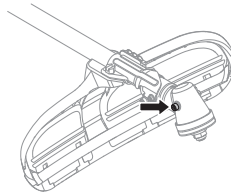

Zündkerze



Der Zustand der Zündkerze wird durch folgende Faktoren verschlechtert:

- Falsch eingestellter Vergaser.
- Falsche Ölmenge im Kraftstoff (zuviel Öl oder falsche Ölart).

WARTUNG

- Verschmutzter Luftfilter.

Diese Faktoren verursachen Beläge an den Elektroden der Zündkerze und können somit zu Betriebsstörungen und Startschwierigkeiten führen.

Bei schwacher Leistung, wenn das Gerät schwer zu starten ist oder im Leerlauf ungleichmäßig läuft, immer zuerst die Zündkerze prüfen, bevor andere Maßnahmen eingeleitet werden. Ist die Zündkerze verschmutzt, so ist sie zu reinigen; gleichzeitig ist zu prüfen, ob der Elektrodenabstand 0,6-0,7 mm beträgt. Die Zündkerze ist nach ungefähr einem Monat in Betrieb oder bei Bedarf öfter auszuwechseln.

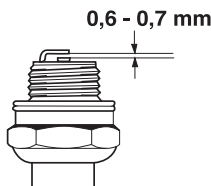

ACHTUNG! Stets den vom Hersteller empfohlenen Zündkerzentyp verwenden! Eine ungeeignete Zündkerze kann Kolben und Zylinder zerstören. Dafür sorgen, dass die Zündkerze eine sog. Funkenstörung hat.

Antriebswelle



Die flexible Antriebswelle wird mit Husqvarna-Antriebswellenfett geschmiert. Die Antriebswelle muss mindestens alle 6 Monate geschmiert werden.

- Den Sperrknopf hochziehen, der den Mantel der Antriebswelle im Kupplungsdeckel hält.

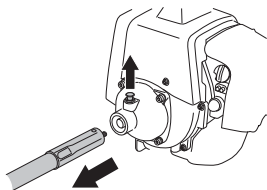

- Den Mantel der Antriebswelle aus dem Kupplungsdeckel ziehen.
- Die Antriebswelle aus dem Mantel herausnehmen, entweder durch Herausschütteln oder durch Herausziehen mit einer Zange.

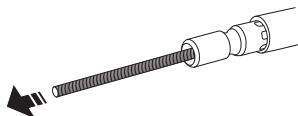

- Tragen Sie das Fett aus der Tube auf der gesamten Welle auf. Verteilen Sie es gleichmäßig mit einer Bürste oder einem Tuch.

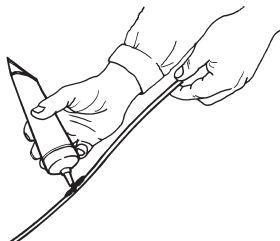

- Die Antriebswelle wieder in den Mantel stecken. Dafür sorgen, dass die Welle eingreift, indem sie beim Eindrücken gleichzeitig gedreht wird.

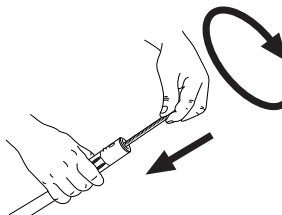

- Wenn die Welle korrekt im Mantel montiert ist, muss das Wellenende ca. 10 mm außerhalb der Mantelkante liegen.

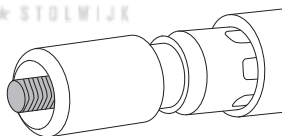

- Den Antriebswellenmantel so in den Kupplungsdeckel montieren, dass das Loch mitten unter dem Sperrknopf am Kupplungsdeckel liegt.

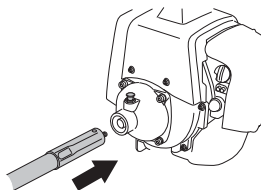

- Biegevelle gleichzeitig drehen und drücken, damit diese richtig sitzt.

WARTUNG

Wartungsschema

Nachstehend sind die an der Maschine vorzunehmenden Wartungsmaßnahmen aufgelistet. Die meisten der Punkte werden im Abschnitt "Wartung" beschrieben. Der Bediener darf nur die Wartungs- und Servicearbeiten ausführen, die in dieser Bedienungsanleitung beschrieben sind. Größere Eingriffe sind von einer autorisierten Servicewerkstatt auszuführen.

Wartung	Tägliche Wartung	Wöchentliche Wartung	Monatliche Wartung
Das Gerät äußerlich reinigen.	X		
Den Tragegurt auf Beschädigungen überprüfen.	X		
Kontrollieren, ob Gashebelsperre und Gashebel ordnungsgemäß funktionieren.	X		
Kontrollieren, ob Handgriff und Lenker intakt und gut befestigt sind.	X		
Die Funktion des Stoppschalters kontrollieren.	X		
Kontrollieren, ob die Schneidausrüstung im Leerlauf rotiert.	X		
Luftfilter reinigen. Bei Bedarf austauschen.	X		
Den Schutz auf Schäden und Risse kontrollieren. Den Schutz austauschen, wenn er Schlägen ausgesetzt war oder Risse aufweist.	X		
Kontrollieren, ob die Klinge gut zentriert, scharf und frei von Rissen ist. Eine Unwucht der Klinge verursacht Vibrationen, die zu Motorschäden führen können.	X		
Den Trimmerkopf auf Schäden und Rissbildung kontrollieren. Bei Bedarf den Trimmerkopf austauschen.	X		
Prüfen, dass die Sicherungsmutter der Schneidausrüstung korrekt angezogen ist.	X		
Der Transportschutz der Klinge muss unbeschädigt sein und sich richtig befestigen lassen.	X		
Schrauben und Muttern nachziehen.	X		
Sicherstellen, dass von Motor, Tank oder Kraftstoffleitungen kein Kraftstoff ausläuft.	X		
Die Startvorrichtung und ihr Startseil kontrollieren.		X	
Die Vibrationsdämpfer auf Beschädigung überprüfen.		X	
Die Zündkerze äußerlich reinigen. Die Zündkerze demontieren und den Elektrodenabstand prüfen. Den Abstand auf 0,6-0,7 mm einstellen oder die Zündkerze austauschen. Dafür sorgen, dass die Zündkerze eine sog. Funkenstörung hat.		X	
Das Kühlsystem des Geräts reinigen.		X	
Den Vergaser von außen und den Bereich um ihn herum reinigen.		X	
Kontrollieren, ob das Winkelgetriebe zu 3/4 mit Schmiermittel gefüllt ist. Bei Bedarf Spezialfett nachfüllen.		X	
Den Schalldämpfer reinigen.			X
Kraftstofffilter auf Verschmutzungen oder Kraftstoffschlauch auf Risse oder andere Schäden untersuchen. Bei Bedarf austauschen.			X
Alle Kabel und Anschlüsse kontrollieren.			X
Kupplung, Kupplungsfedern und Kupplungstrommel auf Verschleiß kontrollieren. Bei Bedarf von einer autorisierten Servicewerkstatt austauschen lassen.			X
Zündkerze austauschen. Dafür sorgen, dass die Zündkerze eine sog. Funkenstörung hat.			X
Die Antriebswelle mit Husqvarna-Antriebswellenfett schmieren.	Dies ist jeden sechsten Monat durchzuführen.		

TECHNISCHE DATEN

Technische Daten

	553RBX
Motor	
Hubraum, cm ³	50,6
Bohrung, mm	45,5
Hublänge, mm	31,1
Leerlaufdrehzahl, U/min	2800
Empfohlene max. Drehzahl, unbelastet, U/min	13000
Drehzahl der Abtriebswelle, U/min	9285
Motorhöchstleistung gemäß ISO 8893, kW/ U/min	2,3/9500
Katalysatorschalldämpfer	Nein
Zündanlage	
Zündkerze	NGK CMR7H
Elektrodenabstand, mm	0,6-0,7
Kraftstoff- und Schmiersystem	
Kraftstofftank, Volumen, Liter	0,8
Gewicht	
Gewicht, ohne Kraftstoff, Schneidausrüstung und Schutz, kg	12,1
Geräuschemissionen	
(siehe Anmerkung 1)	
Gemessene Schalleistung dB(A)	117
Garantierte Schalleistung L _{WA} dB(A)	118
Schallpegel	
(siehe Anmerkung 2)	
Äquivalenter Schalldruckwert am Ohr des Anwenders, gemessen gem. EN ISO 11806 und ISO 22868, dB(A):	
Ausgestattet mit Trimmerkopf (Original)	97
Ausgestattet mit Grasklinge (Original)	97
Vibrationspegel	
(siehe Anmerkung 3)	
Äquivalente Vibrationspegel (a _{hv,eq}) an den Griffen, gemessen gemäß EN ISO 11806 und ISO 22867, m/s ²	
Ausgestattet mit Trimmerkopf (Original), links/rechts	2,7/3,3
Ausgestattet mit Grasklinge (Original), links/rechts	2,7/3,8
Anmerkung 1: Umweltbelastende Geräuschemission gemessen als Schalleistung (L _{WA}) gemäß EG-Richtlinie 2000/14/EG. Der aufgezeichnete Lautstärkepegel für die Maschine wurde unter Verwendung der originalen Schneidausrüstung mit dem höchsten Pegel gemessen. Die Differenz zwischen garantiertem und gemessenem Lautstärkepegel besteht darin, dass bei der garantierten Lautstärke auch eine Streuung im Messergebnis und Variationen zwischen verschiedenen Maschinen desselben Modells gemäß der Richtlinie 2000/14/EG berücksichtigt werden.	
Anmerkung 2: Berichten zufolge entspricht der Schalldruckpegel für diese Maschine normalerweise einer Ausbreitungsklasse (standardmäßige Ausbreitung) von 1 dB (A).	
Anmerkung 3: Berichten zufolge liegt der äquivalente Vibrationspegel normalerweise bei einer Ausbreitungsklasse (Standardabweichung) von 1 m/s ² .	

TECHNISCHE DATEN

Zugelassenes Zubehör	Typ	Schutz für die Schneidausrüstung, Teile-Nr.
Grasklinge/Grasmesser	Multi 300-3 (Ø 300 3-Zähne)	537 33 16-03
	Multi 275-4 (Ø 275 4-Zähne)	537 33 16-03
Trimmerkopf	T45x (Ø 2,7 - 3,3 mm Faden)	537 33 16-03
	T55x (Ø 2,7 - 3,3 mm Faden)	537 33 16-03
Stützkappe	Fest	-

EG-Konformitätserklärung (nur für Europa)

Die **Husqvarna AB**, SE-561 82 Huskvarna, Schweden, Tel. +46-36-146500, erklärt hiermit, dass die Freischneider **Husqvarna 553RBX** von den Seriennummern des Baujahrs 2012 an (die Jahreszahl wird im Klartext auf dem Typenschild angegeben, mitsamt einer nachfolgenden Seriennummer) den Vorschriften der RICHTLINIE DES RATES entsprechen:

- vom 17. Mai 2006 „Maschinen-Richtlinie“ **2006/42/EG**
- vom 15. Dezember 2004 "über elektromagnetische Verträglichkeit" **2004/108/EWG**.
- vom 8. Mai 2000 "über umweltbelastende Geräuschemissionen von zur Verwendung im Freien vorgesehenen Geräten und Maschinen" **2000/14/EG**. Bewertung der Konformität wurde im Sinne von Anhang V durchgeführt. Für Information betreffend die Geräuschemissionen, siehe das Kapitel Technische Daten.

Folgende Normen wurden angewendet: **EN ISO 12100:2010, CISPR 12:2007, ISO 14865:1998**.

SMP Svensk Maskinprovning AB, Fyrisborgsgatan 3, SE-754 50 Uppsala, Schweden, hat die freiwillige Typenprüfung für Husqvarna AB durchgeführt.

Das Prüfzertifikat hat die Nummer: **SEC/12/2344**

Huskvarna, den 8. Februar 2012

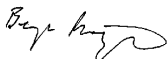

KEES VAN DER SPEK
TUINMACHINES * STOLWIJK

Bengt Frögelius, Entwicklungsleiter (Bevollmächtigter Vertreter für Husqvarna AB, verantwortlich für die technische Dokumentation.)

EXPLICAÇÃO DOS SÍMBOLOS

Símbolos

ATENÇÃO! Um roçador de erva, de arbustos ou recortadora de relva, se indevida ou incorrectamente utilizados pode transformar-se num instrumento perigoso, causando sérios ferimentos ou até a morte do utente ou outras pessoas. É de extrema importância que você leia e compreenda o conteúdo destas instruções para o uso.

Leia as instruções para o uso com toda a atenção e compreenda o seu conteúdo antes de fazer uso da máquina.

Use sempre:

- Capacete de protecção no caso de haver risco de objectos em queda
- Protectores acústicos aprovados
- Protecção ocular aprovada

Rotação máxima no veio de saída, rpm



Este produto está conforme as directivas em validade da CE.



Aviso para objectos lançados e ricochete.



O operador da máquina deve verificar que não se encontre qualquer pessoa ou animal menos de 15 metros, durante o trabalho.



As máquinas equipadas com lâminas de serra ou lâminas para a relva podem ser projectadas violentamente para o lado quando a lâmina entra em contacto com um objecto fixo. Isto chama-se arremesso da lâmina. A lâmina pode amputar um braço ou uma perna. Mantenha sempre pessoas e animais a uma distância de pelo menos 15 metros da máquina.



Marcação com setas de posicionamento que delimitam a posição do suporte do punho.



Ignição; estrangulador: Ponha o estrangulador na posição de estrangular. O contacto de paragem irá automaticamente para a posição de arranque.



Bomba de combustível.



Use sempre luvas de protecção aprovadas.



Use botas estáveis e antidesslizantes.



Utilizar apenas com equipamento de corte flexível, não metálico, ou seja cabeçote de recorte com corda de roçar.



Emissões sonoras para o meio ambiente conforme directiva da Comunidade Europeia. A emissão da máquina é indicada no capítulo Especificações técnicas e no autocolante.



Mantenha todas as partes do seu corpo afastadas de superfícies quentes.



Os restantes símbolos e autocolantes existentes na máquina dizem respeito a exigências específicas para homologação em alguns países.

Controlo e/ou manutenção devem ser efectuados com o motor desligado, com o contacto de paragem na posição STOP.



Use sempre luvas de protecção aprovadas.



Limpeza periódica obrigatória.



Inspeção ocular.



Índice

EXPLICAÇÃO DOS SÍMBOLOS

Símbolos 104

ÍNDICE

Índice 105

Antes de arrancar, observe o seguinte: 105

INTRODUÇÃO

Prezado cliente! 106

COMO SE CHAMA?

As peças do roçador 107

INSTRUÇÕES GERAIS DE SEGURANÇA

Importante 108

Equipamento de protecção pessoal 108

Equipamento de segurança da máquina 109

Equipamento de corte 112

MONTAGEM

Montagem do eixo flexível 114

Ligação do cabo do acelerador e dos fios do interruptor de paragem 114

Montagem do punho em forma de J 114

Montagem da lâmina e cabeçote de recorte 115

Montagem da protecção para transporte 116

Ajuste do suporte e do roçador 116

MANEJO DE COMBUSTÍVEL

Segurança no manejo de combustível 118

Combustível 118

Abastecimento 119

ARRANQUE E PARAGEM

Controlo antes de arrancar 120

Arranque e paragem 120

TÉCNICA DE TRABALHO

Instruções gerais de trabalho 122

MANUTENÇÃO

Carburador 125

Filtro de ar 125

Filtro de combustível 125

Engrenagem angular 125

Vela de ignição 125

Eixo motriz 126

Esquema de manutenção 127

ESPECIFICAÇÕES TÉCNICAS

Especificações técnicas 128

Certificado CE de conformidade 129

Antes de arrancar, observe o seguinte:

Leia as instruções para o uso com toda a atenção.



ATENÇÃO! A exposição prolongada a ruídos pode provocar danos auditivos permanentes. Por isso, use sempre protectores acústicos aprovados.



ATENÇÃO! Sob nenhuma circunstância é permitido modificar a configuração original da máquina sem a autorização expressa do fabricante. Devem usar-se sempre acessórios originais. Modificações e/ou acessórios não autorizados podem acarretar em sérias lesões ou perigo de vida para o utilizador ou outros.



ATENÇÃO! Um roçador de erva, de arbustos ou recortadora de relva, se indevida ou incorrectamente utilizados pode transformar-se num instrumento perigoso, causando sérios ferimentos ou até a morte do utente ou outras pessoas. É de extrema importância que você leia e compreenda o conteúdo destas instruções para o uso.

INTRODUÇÃO

Prezado cliente!

Parabéns pela sua preferência na compra de um produto Husqvarna ! A história da Husqvarna recua no tempo até 1689, quando o rei Karl XI mandou construir uma fábrica na margem da ribeira Huskvarna para fabricar mosquetes. A localização junto à ribeira Huskvarna era lógica, dado que as água da ribeira eram usadas para gerar energia e desta forma se tinha acesso a uma hidrogeradora de energia. Durante os mais de 300 anos de existência da fábrica Husqvarna foram fabricados inúmeros produtos, desde os antigos fogões a lenha às modernas máquinas de cozinha, máquinas de coser, bicicletas, motocicletas, etc. Em 1956 foi lançada a primeira máquina de cortar relva motorizada que em 1959 foi seguida da motosserra, e é neste sector que a Husqvarna actualmente actua.

A Husqvarna é actualmente um dos maiores fabricantes mundiais de produtos florestais e para jardinagem, com a qualidade e o desempenho como prioridade máxima. A ideia comercial é projectar, fabricar e comercializar produtos motorizados para uso florestal e de jardinagem, bem como para a indústria da construção e a indústria fabril. A meta da Husqvarna é também ser ponta de lança no que diz respeito a ergonomia, facilidade de utilização, segurança e consciência ambiental, razão pela qual foram criados vários aperfeiçoamentos para melhorar os produtos nessas áreas.

Estamos convencidos de que será com satisfação que apreciará a qualidade e desempenho dos nossos produtos durante muito tempo no futuro. A compra de qualquer dos nossos produtos dá-lhe acesso a ajuda profissional com reparações e assistência técnica, na eventualidade de, apesar de tudo, acontecer qualquer coisa. No caso do local de compra da máquina não ter sido nenhum dos nossos revendedores autorizados, pergunte-lhes aonde fica a oficina especializada mais próxima.

Esperamos que ficará satisfeito com a sua nova máquina e que ela o acompanhará durante muito tempo. Lembre-se de que estas instruções de utilização são um documento valioso. Seguindo o seu conteúdo (utilização, assistência técnica, manutenção, etc) aumentará consideravelmente a vida útil da máquina bem como o preço de venda em segunda mão da mesma. Se vender a sua máquina, entregue as instruções de utilização ao novo proprietário.

Muito obrigado por usar um produto Husqvarna!

Husqvarna AB efectua o desenvolvimento contínuo dos seus produtos, reservando-se o direito de introduzir modificações referentes, entre outros, ao aspecto e forma dos mesmos sem aviso prévio.

KEES VAN DER SPEK
TUINMACHINES * STOLWIJK

COMO SE CHAMA?

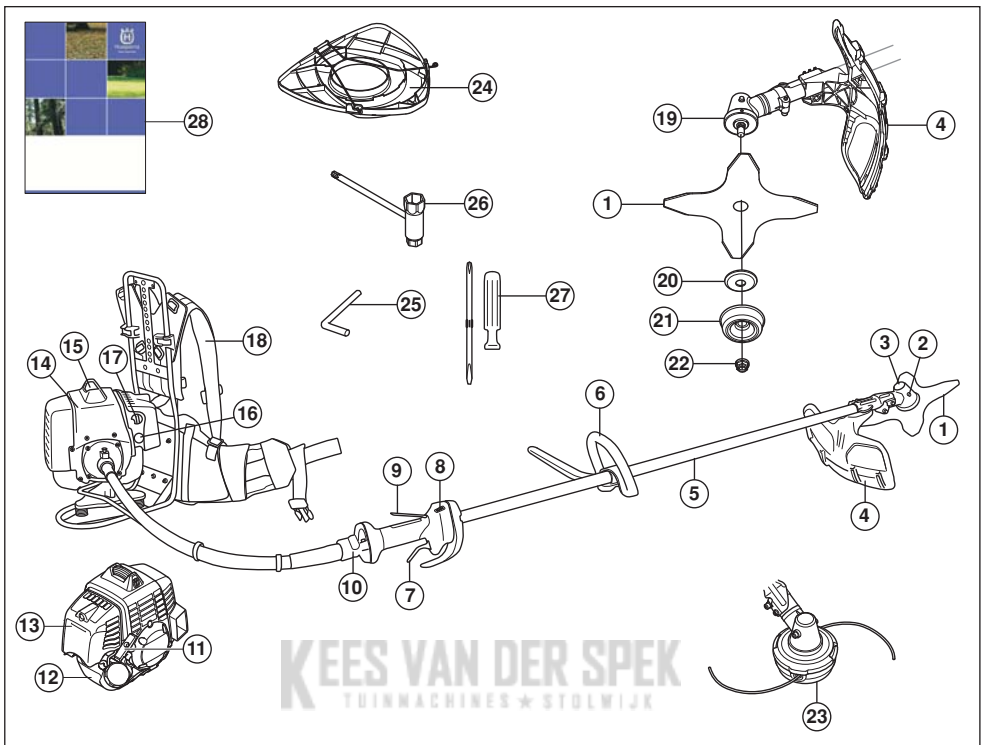

As peças do roçador

- | | |
|--|---|
| 1 Lâmina | 15 Vela de ignição e protecção da vela. |
| 2 Enchimento de massa lubrificante, engrenagem angular | 16 Bomba de combustível. |
| 3 Engrenagem angular | 17 Arranque a frio |
| 4 Protecção do equipamento de corte | 18 Correia de suporte |
| 5 Tubo | 19 Accionador |
| 6 Punho fechado | 20 Flange de apoio |
| 7 Acelerador | 21 Copo de apoio |
| 8 Contacto de paragem | 22 Porca de freio |
| 9 Bloqueio do acelerador | 23 Cabeçote de recorte |
| 10 Acoplamento do tubo | 24 Protecção para transporte |
| 11 Pega do arranque | 25 Pino de freio |
| 12 Depósito de combustível | 26 Chave da porca da lâmina |
| 13 Cobertura do filtro de ar | 27 Chave de parafusos |
| 14 Cobertura do cilindro | 28 Instruções para o uso |

INSTRUÇÕES GERAIS DE SEGURANÇA

Importante

IMPORTANTE!

A máquina é construída somente para recortar relva e roçar erva.

Os únicos acessórios em que pode usar o motor como propulsor são os equipamentos de corte recomendados no capítulo Especificações técnicas.

Nunca use a máquina se estiver cansado, se bebeu álcool ou se toma remédios que podem influir na sua visão, discernimento ou controlo sobre o corpo.

Use equipamento de protecção pessoal. Ver as instruções na secção "Equipamento de protecção pessoal".

Nunca use uma máquina que foi modificada a ponto de não mais corresponder à construção original.

Nunca use uma máquina defeituosa. Siga as instruções de manutenção, controlo e assistência técnica destas instruções para o uso. Alguns serviços de manutenção e de assistência técnica deverão ser executados por especialistas qualificados. Ver as instruções na secção Manutenção.

Todas as coberturas, protecções e punhos têm que estar montados antes de se pôr a máquina a funcionar. Verifique se a cobertura e o cabo vela de ignição estão em bom estado para evitar o risco de choque eléctrico.

O utente da máquina deve verificar se não se encontra qualquer pessoa ou animal num raio de 15 metros. Sempre que trabalhem vários utentes ao mesmo tempo e no mesmo local, a distância de segurança deve ser, no mínimo, o dobro do comprimento da árvore mas nunca menos de 15 metros.



ATENÇÃO! Esta máquina produz um campo electromagnético durante o funcionamento. Em determinadas circunstâncias, este campo pode interferir com o funcionamento de implantes médicos activos ou passivos. Para reduzir o risco de lesões graves ou mortais, recomendamos que portadores de dispositivos implantados consultem o seu médico e o fabricante do implante antes de utilizar a máquina.



ATENÇÃO! A utilização dum motor em ambiente fechado ou mal ventilado pode causar a morte por asfixia ou envenenamento por gás carbónico.



ATENÇÃO! Não permita nunca que uma criança use a máquina ou se encontre na proximidade da mesma. Devido à máquina estar equipada com contacto de paragem elástico e poder ser posta a funcionar a baixa velocidade e pouca força desde o punho de arranque, podem até crianças pequenas, em determinadas circunstâncias, ter força suficiente para dar o arranque à máquina. Isso pode implicar perigo de lesões graves. Por isso, retire sempre a protecção da vela quando a máquina não estiver sob vigilância.

Equipamento de protecção pessoal

IMPORTANTE!

Um roçador de erva, de arbustos ou recortadora de relva, se indevida ou incorrectamente utilizados pode transformar-se num instrumento perigoso, causando sérios ferimentos ou até a morte do utente ou outras pessoas. É de extrema importância que você leia e compreenda o conteúdo destas instruções para o uso.

Em quaisquer circunstâncias de utilização da máquina deve ser utilizado equipamento de protecção pessoal aprovado. O equipamento de protecção pessoal não elimina o risco de lesão mas reduz os seus efeitos em caso de acidente. Consulte o seu concessionário na escolha do equipamento.



ATENÇÃO! Esteja sempre atento a sinais de alarme ou avisos de viva voz quando usar protectores acústicos. Retire os protectores acústicos logo que o motor tenha parado.

CAPACETE

Capacete de protecção no caso de haver risco de objectos em queda



PROTECTORES ACÚSTICOS

Devem-se usar protectores acústicos com suficiente insonorização.



INSTRUÇÕES GERAIS DE SEGURANÇA

PROTECÇÃO OCULAR

Deve sempre usar-se protecção ocular aprovada. Mesmo que se use viseira, devem usar-se óculos de protecção aprovados. Consideram-se óculos de protecção aprovados, os que estejam conformes com a norma ANSI Z87.1 nos EUA ou EN 166 nos países da UE.



LUVAS

Deve-se usar luvas quando necessário, p. ex., na montagem do equipamento de corte.



BOTAS

Use botas estáveis e antidesslizantes.



VESTUÁRIO

Use roupas de material resistente e evite vestimentas demasiado largas que se possam prender facilmente em galhos e arbustos. Use sempre calças compridas grossas. Não use jóias, shorts ou outras calças curtas e não ande de sandálias ou descalço. O cabelo não deve passar abaixo dos ombros.

PRIMEIROS SOCORROS

Os primeiros socorros devem sempre estar à mão.



Equipamento de segurança da máquina

Nesta secção esclarecem-se quais são as peças de segurança da máquina, que função desempenham e ainda como efectuar o controlo e a manutenção para se certificar da sua operacionalidade. Ver capítulo Como se chama?, para localizar onde estas peças se encontram na sua máquina.

A duração da máquina pode ser afectada e o perigo de acidentes pode aumentar se a manutenção da máquina não for correcta e se as revisões e reparações não forem executadas de forma profissional. Se necessitar de mais esclarecimentos, entre em contacto com uma oficina autorizada.

IMPORTANTE! Toda a assistência e reparação da máquina requer formação especializada. Especialmente no que se refere ao equipamento de segurança. Se a máquina não satisfizer algum dos controlos abaixo mencionados, procure a sua oficina autorizada. A compra de qualquer dos nossos produtos garante-lhe a obtenção de reparação e assistência profissionais. Se o local da compra da máquina não for um dos nossos concessionários com assistência técnica, consulte a oficina autorizada mais próxima.



ATENÇÃO! Nunca use uma máquina com equipamento de segurança defeituoso. O equipamento de segurança da máquina deverá ser controlado e a sua manutenção feita conforme se descreve nesta secção. Se a sua máquina não satisfizer a algum desses controlos, deverá ser enviada a uma oficina autorizada para reparação.

Bloqueio do acelerador

O bloqueio do acelerador é construído para evitar a activação involuntária do acelerador. Quando se comprime o bloqueio (A) no punho (= quando se agarra no punho), liberta-se o acelerador (B). Quando se solta o punho, tanto o acelerador como o bloqueio retornam às suas posições originais. Isso ocorre por meio de dois sistemas de molas de retorno, independentes entre si. Esta posição significa que o acelerador automaticamente é levado para a marcha em vazio.

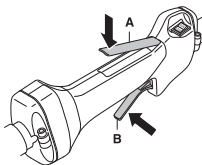

Verifique se o acelerador está fixo na posição marcha em vazio quando o bloqueio de acelerador estiver na sua posição original.

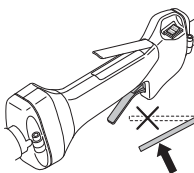

Comprima o bloqueio do acelerador e verifique se este retorna à sua posição original quando libertado.

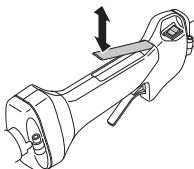

INSTRUÇÕES GERAIS DE SEGURANÇA

Verifique se o acelerador e o bloqueio do acelerador funcionam com facilidade e se os seus respectivos sistemas de mola de retorno funcionam.

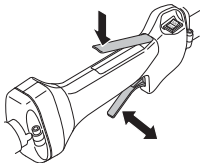

Veja instruções na secção Arranque. Arranque com a máquina e acelere a fundo. Solte o acelerador e verifique se o equipamento de corte pára e permanece imóvel. Se o equipamento de corte girar com o acelerador na marcha em vazio, controle o ajuste da marcha em vazio do carburador. Ver instruções no capítulo Manutenção.

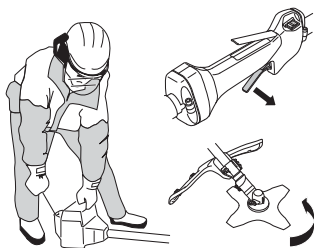

Contacto de paragem

O contacto de paragem é usado para desligar o motor.

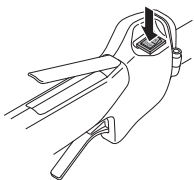

Arranque o motor e verifique se este se desliga quando o contacto de paragem é levado à posição de paragem.

Protecção do equipamento de corte

Esta protecção destina-se a evitar que objectos soltos sejam lançados contra o utente. A protecção evita também que o utente entre em contacto com o equipamento de corte.

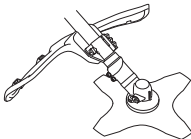

Verifique se a protecção está em bom estado e sem rachaduras. Troque a protecção se esta foi sujeita a golpes ou se tem rachaduras.

Use sempre a protecção recomendada para o equipamento de corte específico. Veja o capítulo Especificações técnicas



ATENÇÃO! Não pode ser utilizado, seja a que título for, equipamento de corte sem que esteja montada uma protecção aprovada. Veja no capítulo Especificações técnicas. Caso seja montada uma protecção errada ou defeituosa, isto pode causar sérios danos pessoais.

Sistema anti-vibração



A máquina está equipada com um sistema de amortecimento de vibrações, construído de forma a propiciar uma utilização tão confortável e isenta de vibrações quanto possível.

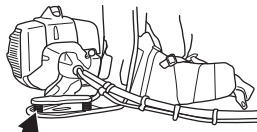

O uso de corda mal enrolada ou de equipamento de corte sem gume ou incorrecto (de tipo errado ou mal afiado, veja secção Limagem da lâmina) aumenta o nível de vibrações.

O sistema de amortecimento de vibrações da máquina reduz a transmissão das vibrações entre a parte do motor/equipamento de corte e a parte dos punhos.

Verifique periodicamente os elementos anti-vibração quanto a rachaduras no material e deformações.

Verifique se os elementos anti-vibração estão inteiros e bem fixos.



ATENÇÃO! A exposição excessiva a vibrações pode levar a lesões arteriais ou nervosas em pessoas que tenham distúrbios do aparelho circulatório. Procure um médico se constatar sintomas corporais que se possam relacionar com exposição excessiva a vibrações. Exemplos desses sintomas são entorpecimento, ausência de tacto, comichões, "pontadas", dor, ausência ou redução da força normal, mudanças na cor da pele ou na sua superfície. Esses sintomas surgem normalmente nos dedos, mãos ou pulsos. O risco dessas lesões pode aumentar a baixas temperaturas.

INSTRUÇÕES GERAIS DE SEGURANÇA

Silenciador

O silenciador é construído para propiciar o mais baixo nível de ruído possível bem como desviar os gases de escape do utilizador. Os silenciadores equipados com catalisador também se destinam a reduzir matérias prejudiciais dos gases de escape.

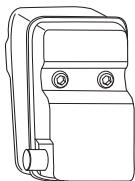

Nunca use uma máquina com silenciador defeituoso.

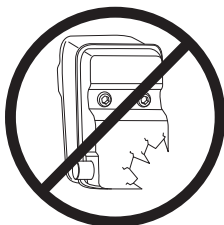

Verifique regularmente se o silenciador está fixo à máquina.

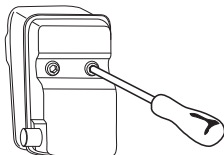

Se a sua máquina estiver equipada com um abafachamas, este deverá ser submetido a uma limpeza periódica. A rede obstruída leva a um aquecimento que pode acarretar sérios danos para o motor.



ATENÇÃO! O silenciador com catalisador aquece muito, tanto durante a utilização como após a paragem. Isto também se verifica na marcha em vazio. O contacto com o mesmo poderá causar queimaduras na pele. Cuidado com os riscos de incêndio!



ATENÇÃO! O interior do silenciador contém produtos químicos potencialmente cancerígenos. Evite o contacto directo com esses produtos se tiver um silenciador danificado.



ATENÇÃO! Tenha em mente o seguinte: Os gases de escape do motor são quentes e podem conter faíscas causadoras de incêndios. Portanto, nunca arranque com a máquina em interiores ou nas proximidades de material inflamável!

Porca de freio

Na fixação de alguns tipos de equipamento de corte são usadas porcas de freio.



Após montar, aperte a porca no sentido oposto ao sentido de rotação do equipamento de corte. Para desmontar, desaperte a porca no sentido da rotação do equipamento de corte. (NOTA! A porca tem rosca à esquerda.) Aperte a porca com a chave de aperto da porca do disco.

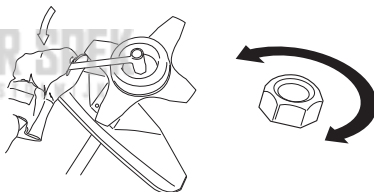

O fixador de nylon da porca de freio não deverá estar gasto a ponto de se poder apertar com os dedos. O aperto deverá manter um mínimo de 1,5 Nm. A porca deve ser substituída depois de ser apertada cerca de 10 vezes.

Correia de suporte



Verifique se a correia de suporte está intacta.

Numa situação de emergência, solte-se da máquina e do arnês de acordo com o método seguinte.

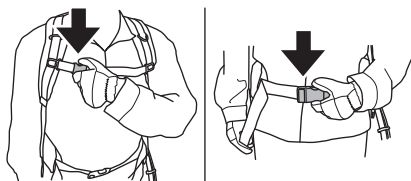

INSTRUÇÕES GERAIS DE SEGURANÇA

Equipamento de corte

Esta secção mostra como você, através de uma correcta manutenção e uso do equipamento de corte correcto, poderá:

- Reduzir as tendências da máquina a retrocesso.
- Conseguir máxima capacidade de corte.
- Aumentar a vida útil do equipamento de corte.

IMPORTANTE!

Use somente o equipamento de corte junto com a protecção recomendada! Veja o capítulo Especificações técnicas.

Veja nas instruções do equipamento de corte como carregar correctamente a corda e como escolher o diâmetro de corda certo.

Mantenha os dentes de corte da lâmina sempre bem e correctamente afiados! Siga as nossas recomendações. Veja também as instruções na embalagem da lâmina.



ATENÇÃO! Pare sempre o motor antes de trabalhar no equipamento de corte. Este continua a girar mesmo depois de se soltar o acelerador. Verifique se o equipamento de corte parou completamente e retire o cabo da vela de ignição antes de começar o trabalho nesse equipamento.



ATENÇÃO! Um equipamento de corte incorrecto ou uma lâmina erradamente limada aumentam o risco de acidentes.

Equipamento de corte

As lâminas e facas para erva destinam-se a roçar erva espessa.

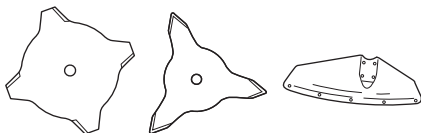

O cabeçote de recorte destina-se ao corte de relva.



Regras básicas



Use somente o equipamento de corte junto com a protecção recomendada! Veja o capítulo Especificações técnicas.

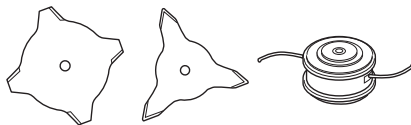

Mantenha os dentes de corte da lâmina correctamente afiados! Siga as nossas instruções e use o calibrador de lima recomendado. Uma lâmina mal afiada ou danificada aumenta os riscos de acidentes.

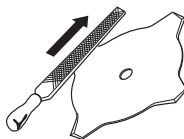

Verifique se o equipamento de corte está danificado ou com rachaduras. Um equipamento de corte danificado deve sempre ser substituído.



Limagem da faca e da lâmina para erva



- Veja as instruções na embalagem do equipamento de corte para limagem correcta. A lâmina e a faca limam-se com uma lima plana de grau simples.
- Lime todos os gumes igualmente para conservar o equilíbrio.

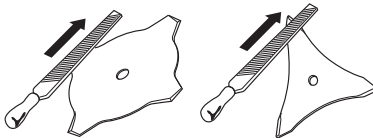

ATENÇÃO! Deite sempre fora lâminas encurvadas, empenadas, rachadas, partidas ou por qualquer outro modo danificadas. Nunca tente desempenar uma lâmina para a reutilizar. Use somente lâminas originais do tipo especificado.

INSTRUÇÕES GERAIS DE SEGURANÇA

Cabeçote de recorte

IMPORTANTE!

Certifique-se sempre de que a corda de corte seja enrolada firme e uniformemente no tambor, para evitar a ocorrência de vibrações prejudiciais à saúde na máquina.

- Use somente os cabeçotes e cordas de corte recomendados. Foram testados pelo fabricante para se adequarem a um determinado tamanho de motor. Isto é de especial importância quando se usar um cabeçote de recorte totalmente automático. Use somente o equipamento de corte recomendado. Ver Especificações técnicas.



- De modo geral, uma máquina pequena requer cabeçotes de recorte pequenos e vice-versa. Isto pelo facto de que, ao cortar com a corda, o motor tem de lançar a corda radialmente a partir do cabeçote de recorte e ainda vencer a resistência da relva a cortar.
- O comprimento da corda também é importante. Uma corda mais comprida requer maior potência do motor do que uma corda curta de igual diâmetro.
- Certifique-se de que a faca que se encontra na protecção de recorte esteja intacta. Ela é usada para cortar a corda ao comprimento certo.
- Para obter maior vida útil para a corda, esta pode ser posta de molho na água por uns dois dias. A corda torna-se então mais rija e dura mais.

MONTAGEM

Montagem do eixo flexível

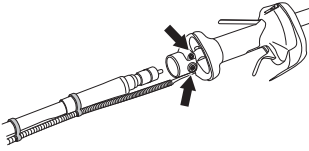

- Solte os dois parafusos do acoplamento do eixo.
- 
- Deslize o eixo flexível pelas aberturas na cablagem e encaixe o eixo flexível no acoplamento do eixo. Certifique-se de que o eixo está instalado correctamente, fazendo-o rodar e empurrando simultaneamente.
 - Aperte os dois parafusos.
 - Monte a capa do eixo motriz na cobertura do acoplamento de forma que o furo fique centrado com o freio na cobertura do acoplamento.

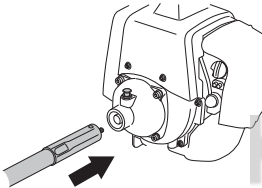

- Certifique-se de que o eixo está instalado correctamente, fazendo-o rodar e empurrando simultaneamente.
- Assegure-se de que o pino de bloqueio regressa à sua posição original, de modo que a manga do eixo motriz não consiga soltar-se da caixa da embraiagem.

Ligação do cabo do acelerador e dos fios do interruptor de paragem



- Coloque o fio do acelerador vindo da cablagem (A) e o fio do acelerador vindo do motor (B) na manga de plástico, tal como se mostra.

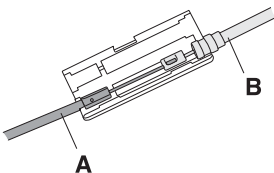

- Feche a manga de plástico.
- Ligue os fios do interruptor de paragem aos conectores correspondentes do motor. Tenha em atenção que a polaridade do fio não é importante.

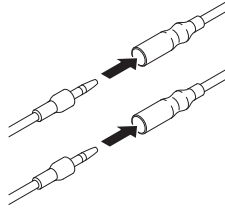

Montagem do punho em forma de J



- Encoste o punho contra o tubo. Tenha cuidado para que o punho fique montado abaixo da seta de marcação do tubo.

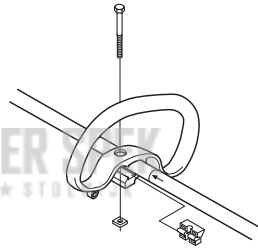

- Introduza o espaçador na ranhura do punho fechado.
- Monte a porca e o parafuso. Não aperte demasiado.
- O punho em forma de J é montado no punho fechado conforme a figura.

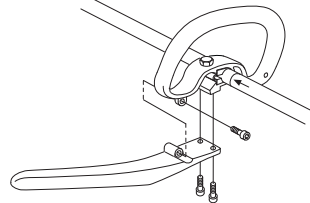

- Afine agora a posição para que o recortador tenha uma posição de trabalho cómoda. Aperte o parafuso/maçaneta.

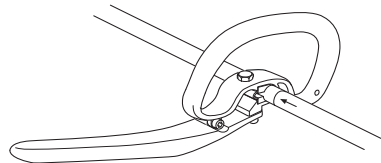

MONTAGEM



ATENÇÃO! Ao montar o punho em forma de J, só é permitido o uso de lâminas para erva/facas para erva ou do cabeçote de recorte/facas de plástico. A lâmina de serra nunca deve ser usada com o punho em forma de J.

Montagem da lâmina e cabeçote de recorte



ATENÇÃO! Ao montar o equipamento de corte, é de extrema importância que o accionador/flange de apoio se ajuste correctamente ao furo central do equipamento de corte. Se o equipamento de corte não estiver montado correctamente, poderá originar danos pessoais graves, com perigo de morte.

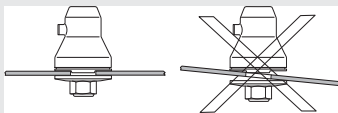

ATENÇÃO! Não pode ser utilizado, seja a que título for, equipamento de corte sem que esteja montada uma protecção aprovada. Veja no capítulo Especificações técnicas. Caso seja montada uma protecção errada ou defeituosa, isto pode causar sérios danos pessoais.

IMPORTANTE! Para trabalhar com a lâmina de serra ou relva, a máquina deve estar equipada com a direcção, protecção da lâmina e suporte correctos e adequados.

Montagem da guarda



NOTA! Ao usar cabeça aparadora/facas de plástico e protecção combinada, a guarda deve sempre estar montada. Ao usar disco para a relva e protecção combinada, a guarda deve ser desmontada.

A protecção da lâmina/protecção combinada (A) engancha no suporte do tubo e é fixada com um parafuso.

Enfie a guia da guarda no sulco da protecção combinada. Encaixe depois a guarda na protecção e fixe-a com os quatro fechos rápidos.

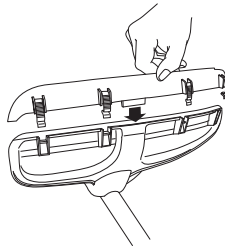

A extensão da guarda é fácil de remover com uma chave de fendas (ver figura).

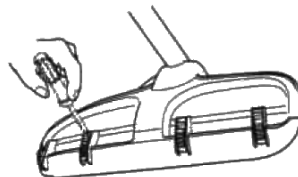

Montagem da protecção de lâmina, lâmina de relva e faca de relva



- A protecção da lâmina/protecção combinada (A) engancha no suporte do tubo e é fixada com um parafuso (L). Use a protecção de lâmina recomendada. Ver o capítulo Especificações técnicas. **NOTA!** Verifique se a guarda está desmontada.

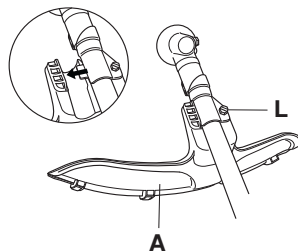

- Monte o accionador (B) na ponta do eixo de saída.
- Gire o eixo da lâmina até que um dos orifícios do accionador coincida com o orifício correspondente na caixa de engrenagens.
- Introduza o pino de freio (C) no orifício para frear o eixo.
- Coloque a lâmina (D), copo de apoio (E) e flange de apoio (F) no eixo de saída.
- Monte a porca (G). A porca é apertada ao binário de 35-50 Nm (3,5-5 kgm). Use a chave de caixa do jogo

MONTAGEM

de ferramentas. Mantenha o cabo da chave o mais próximo possível da protecção da lâmina. A porca aperta-se quando a chave é girada contra o sentido de rotação (CUIDADO! rosca à esquerda).

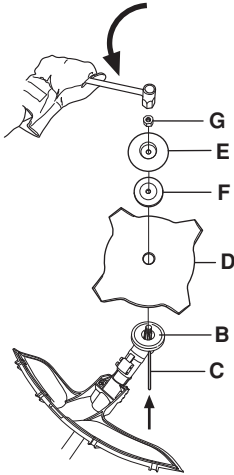

Montagem da protecção de recorte e do cabeçote de recorte



- Colocar a protecção de recorte (A) para trabalho com a cabeça de recorte. NOTA! Verifique se a guarda está montada.

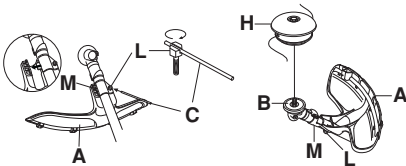

- A protecção de recorte/protecção combinada é engatada no tubo e fixada com um parafuso (L).
- Monte o accionador (B) na ponta do eixo de saída.
- Gire o eixo da lâmina até que um dos orifícios do accionador coincida com o orifício correspondente na caixa de engrenagens.
- Introduza o pino de freio (C) no orifício para frear o eixo.

- Atiraxe o cabeçote de recorte/facas de plástico (H) no sentido contrário ao da rotação.

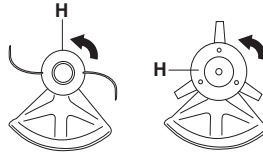

- A desmontagem é feita pela ordem inversa.

Montagem da protecção para transporte



- Insira a lâmina na protecção para transporte (A).
- Encaixe os dois fechos (B) nas ranhuras (C), para fixar a protecção de transporte.

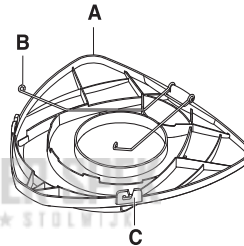

Ajuste do suporte e do roçador



Ajustamento da altura do suporte das costas

- Solte os dois fechos de engate que seguram o suporte das costas.

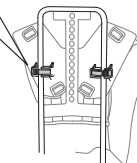
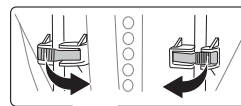

MONTAGEM

- Solte o suporte das costas da moldura, de um dos lados.

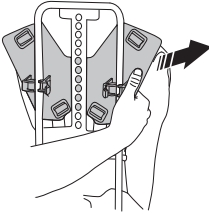

- Coloque o suporte das costas à altura pretendida e aperte-o. Assegure-se de que o pino fica alinhado com um dos orifícios na moldura, ver imagem.

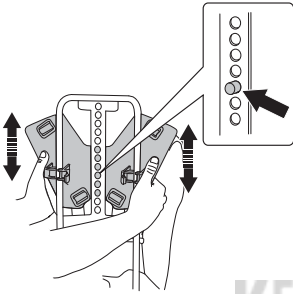

Ajuste do suporte

- Pegue no suporte.
- Aperte a correia de cintura de modo a fazê-la assentar com estabilidade.



- Aperte a correia de peito.



- Ajuste a correia de peito verticalmente, se necessário, e assegure-se de que assenta bem.

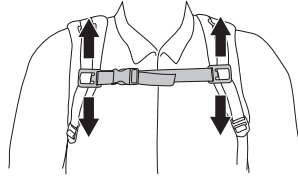

- Ajuste as correias dos ombros de modo a distribuir a carga homogeneamente pelos dois ombros.



- Solte ou aperte a correia de cintura de modo a que aprox. 70% da carga se apoie na cintura e 30% nos ombros.

KEES VAN DER SPEK
TUINMACHINES * STOLWIJK

MANEJO DE COMBUSTÍVEL

Segurança no manejo de combustível

Nunca arranque com a máquina:

- 1 Se derramou combustível sobre a máquina. Remova todo o líquido derramado e deixe que os restos de gasolina se evaporem.
- 2 Se derramou combustível sobre si próprio ou na sua roupa, troque de roupa. Lave as partes do corpo que estiverem em contacto com o combustível. Lave com água e sabonete.
- 3 Se a máquina tiver fuga de combustível. Controle regularmente se há fugas na tampa do depósito e nos tubos de combustível.

Transporte e armazenagem

- Guarde e transporte a máquina e o combustível de modo tal que não haja o risco de possíveis fugas e vapores entrarem em contacto com fontes de faíscas ou chama aberta, tais como máquinas e motores eléctricos, contactos/interruptores eléctricos ou mesmo caldeiras.
- Ao armazenar e transportar combustível, utilize recipiente especialmente destinado e aprovado para esse fim.
- Em armazenagem por tempo prolongado, o depósito de combustível da máquina deve ser esvaziado. Consulte o posto de abastecimento mais próximo sobre como proceder com o combustível excedente.
- Certifique-se de que a máquina foi cuidadosamente limpa e submetida a uma revisão completa antes de ser armazenada por tempo prolongado.
- A protecção para transporte do equipamento de corte deve sempre estar montada, durante o transporte ou armazenagem da máquina.
- Trave a máquina durante o transporte.



ATENÇÃO! O combustível e os vapores do combustível são muito inflamáveis e podem causar graves lesões em caso de inalação ou contacto com a pele. Seja portanto cauteloso ao manusear combustível e providencie de modo a haver boa ventilação durante o manuseamento de combustível.

Gasolina



NOTA! Use sempre mistura de óleo com gasolina de qualidade com um mínimo de 90 octanas (RON). Se a sua máquina estiver equipada com catalisador (ver capítulo Especificações técnicas), deverá usar sempre gasolina sem chumbo misturada com óleo. A gasolina com chumbo destrói o catalisador.

Sempre que esteja disponível gasolina ecológica, a chamada gasolina alquílica, esta deve ser utilizada.



- O índice de octano mínimo recomendado é 90 (RON). No caso do motor funcionar com gasolina com um índice de octano inferior a 90, o motor pode começar a "grilar". Isso pode causar um aumento de temperatura no motor que pode causar graves avarias no mesmo.
- Ao trabalhar continuamente em rotação alta, recomenda-se um índice de octano mais elevado.

Óleo de dois tempos

- Para obter o melhor resultado e rendimento, use óleo para motores a dois tempos HUSQVARNA, produzido especialmente para os nossos motores a dois tempos arrefecidos a ar.
- Não use nunca óleo para motores fora de borda a dois tempos e arrefecidos a água, também chamado 'óleo para foras de borda' (designado TCW).
- Nunca use óleo para motores a quatro tempos.
- Um óleo de baixa qualidade ou uma mistura de óleo/combustível demasiado rica podem aventurar o funcionamento do catalizador e reduzir-lhe a vida útil.
- Proporção de mistura
1:50 (2%) com óleo para motores a dois tempos HUSQVARNA.
1:33 (3%) com outros óleos para motores de dois tempos arrefecidos a ar, com homologação JASO FB/ISO EGB.



ATENÇÃO! Tenha cuidado ao manusear combustível. Pense nos riscos de incêndio, explosão e inalação.

Combustível

NOTA! A máquina está equipada com um motor de dois tempos e deve sempre funcionar com uma mistura de gasolina e óleo para motores de dois tempos. Para assegurar a mistura correcta é importante medir cuidadosamente a quantidade de óleo a ser misturada. No caso de pequenas quantidades de combustível a misturar, até pequenos erros na quantidade de óleo influem fortemente na proporção da mistura.

MANEJO DE COMBUSTÍVEL

Gasolina, litros	Óleo de dois tempos, litros	
	2% (1:50)	3% (1:33)
5	0,10	0,15
10	0,20	0,30
15	0,30	0,45
20	0,40	0,60

Mistura

- Misture sempre gasolina e óleo num recipiente limpo e aprovado para gasolina.
- Comece sempre por juntar metade da gasolina a ser misturada. Junte depois todo o óleo. Agite bem a mistura. Por fim, junte o restante da gasolina.
- Agite a mistura cuidadosamente antes de a despejar no depósito de combustível da máquina.

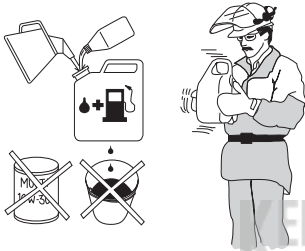

- Não misture combustível além do necessário para se consumir durante um mês, no máximo.
- Se a máquina não for usada por um longo período, esvazie o depósito de combustível e limpe-o.



ATENÇÃO! O silenciador com catalisador fica extremamente quente durante a utilização e após a paragem. Isto aplica-se inclusivamente ao funcionamento na marcha em vazio. Tome cuidado com os riscos de incêndio, especialmente ao manear próximo a materiais e/ou gases inflamáveis.

Abastecimento



ATENÇÃO! As medidas de precaução abaixo diminuem os riscos de incêndio:

Não fume nem ponha nenhum objecto quente nas proximidade do combustível.

Nunca abasteça com o motor em funcionamento.

Pare o motor e deixe arrefecer alguns minutos antes de abastecer.

Abra a tampa do depósito devagar, ao abastecer, para dar saída lenta aos gases se houver um excesso de pressão.

Aperte bem a tampa do depósito após abastecer.

Afaste sempre a máquina do local e da fonte de abastecimento, antes de arrancar.

- Use reservatórios de combustível com protecção contra enchimento excessivo.
- Seque bem à volta da tampa do depósito. Sujidades no depósito causam problemas de funcionamento.
- Certifique-se de que o combustível está bem misturado, agitando o recipiente antes de encher o depósito.



Min 3 m
(10 ft)



ARRANQUE E PARAGEM

Controlo antes de arrancar



- Nunca use a máquina sem protecção ou com protecção danificada.
- Todas as coberturas devem estar devidamente montadas e intactas antes do arranque da máquina.
- Verifique na lâmina se não há rachaduras na base dos dentes ou no furo central. O motivo mais comum de formação de rachaduras são cantos afiados na base dos dentes, criados por limagem ou por ter a lâmina sido usado com dentes cegos. Deite fora a lâmina se descobrir rachaduras.

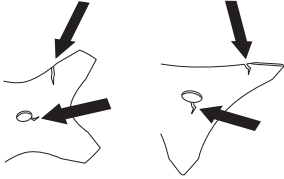

- Verifique o flange de apoio para que não haja nenhuma rachadura, devido a fadiga ou aperto excessivo. Deite fora o flange de apoio caso tenha rachaduras.

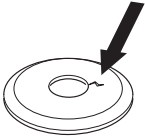

- Certifique-se de que a porca de freio não perca a sua força. O seu binário de bloqueio deve ser no mínimo de 1,5 Nm. O seu binário de aperto deve ser de 35-50 Nm.



- Verifique a protecção da lâmina quanto a danos e rachaduras. Substitua a protecção da lâmina se esta tiver sido sujeita a golpes ou apresentar rachaduras.

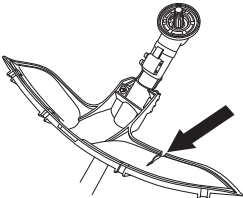

- Verifique o cabeçote de recorte e a protecção de recorte quanto a danos e rachaduras. Substitua o cabeçote de recorte ou a protecção de recorte se

tiverem sido sujeitos a golpes ou apresentarem rachaduras.

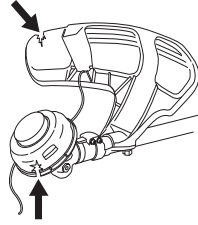

Arranque e paragem



ATENÇÃO! A cobertura da embraiagem, completa com o tubo, tem que estar montada antes da máquina arrancar, para que não possa soltar-se e causar lesões pessoais.

Afasto sempre a máquina do local e da fonte de abastecimento, antes de arrancar. Coloque a máquina numa base sólida. Assegure-se de que o equipamento de corte não possa tocar em nenhum objecto.

Não permita a presença de pessoas estranhas na área de trabalho, sob risco de danos pessoais sérios. A distância de segurança é de 15 metros.

Arranque



Ignição: Leve o contacto de paragem à posição de arranque.

Bomba de combustível: Premir a bolha de borracha da bomba de combustível repetidas vezes, até que o combustível comece a encher a bolha. Não é necessário encher a bolha completamente.

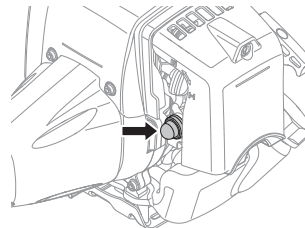

ARRANQUE E PARAGEM

Estrangulador: Ponha o comando na posição de estrangulador.

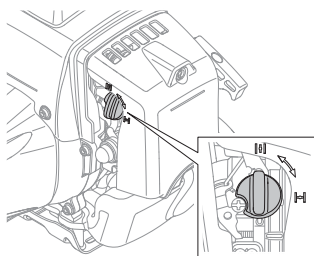

ATENÇÃO! Quando o motor é posto em marcha com o arranque a frio na posição de choke ou aceleração de arranque, o equipamento de corte começa imediatamente a girar.

Pressione o corpo da máquina contra o solo com a mão esquerda (NOTA! Não o faça com o pé!). Agarre depois a pega do arranque com a mão direita e puxe a corda lentamente até sentir resistência (o mecanismo de arranque começa a actuar) e em seguida puxe com movimentos rápidos e fortes. **Nunca enrole a corda de arranque na mão.**

Restabeleça imediatamente o arranque a frio quando houver explosão no motor e faça repetidas tentativas até o motor arrancar. Quando arrancar, acelere rapidamente ao máximo e a mistura de arranque desligar-se-á automaticamente.

NOTA! Não puxe inteiramente a corda de arranque nem solte a pega do arranque se estiver em posição totalmente distendida. Esta prática pode danificar a máquina.

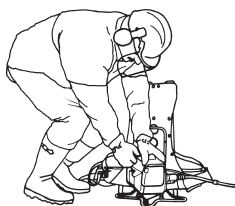

NOTA! Não colocar nenhuma parte do corpo na superfície marcada. Contacto com a mesma pode resultar em queimaduras na pele ou choque eléctrico se a protecção da vela estiver defeituosa. Use sempre luvas.

Nunca utilize uma máquina com a protecção da vela defeituosa.

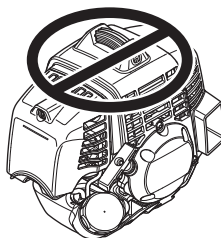

Paragem



O motor pára ao desligar a ignição.

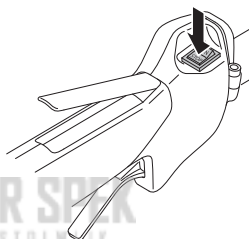

TÉCNICA DE TRABALHO

Instruções gerais de trabalho

IMPORTANTE!

Esta secção aborda regras básicas de segurança para o trabalho com o roçador e a recortadora.

Se você se sentir inseguro sobre o modo de prosseguir com o trabalho, consulte um especialista. Dirija-se ao seu revendedor ou à sua oficina autorizada.

Evite toda a forma de uso para a qual se sinta insuficientemente qualificado.

Antes de usar, você deverá compreender a diferença entre desbravamento florestal, roçadura de relva e recorte de relva.

Regras básicas de segurança



- 1 Observe a vizinhança:
 - Para assegurar-se de que pessoas, animais ou outro factor não possam interferir no seu controlo sobre a máquina.
 - Para evitar que pessoas, animais ou outros possam entrar em contacto com o equipamento de corte ou objectos soltos que possam ser arremessados à distância pelo equipamento de corte.
 - **NOTA!** Nunca use uma máquina sem que possa pedir ajuda em caso de acidente.
- 2 Inspeccione a área de trabalho. Remova objectos soltos tais como pedras, pedaços de vidro, pregos, arame, cordas, etc., que possam ser arremessados ou enredar-se no equipamento de corte.
- 3 Evite o uso em condições meteorológicas desfavoráveis. Por exemplo, em denso nevoeiro, chuva e vento fortes, frio intenso, etc. Trabalhar com mau tempo é cansativo e pode ocasionar situações perigosas, por exemplo, solo escorregadio, influência na direcção de abate das árvores, etc.
- 4 Certifique-se de que pode andar e estar de pé com segurança. Tenha cuidado com eventuais obstáculos em caso de um deslocamento inesperado (raízes, pedras, galhos, buracos, valas, etc.). Use de extrema precaução ao trabalhar em terreno inclinado.



- 5 Transporte sempre este soprador do tipo mochila com as correias de ombros durante a operação.
- 6 Mantenha bom equilíbrio e apoio para os pés.
- 7 Segure sempre a máquina com as duas mãos.
- 8 Tenha o equipamento de corte abaixo do nível da cintura.
- 9 Ao deslocar-se, desligue o motor. Em deslocamentos mais longos bem como durante transportes, use a protecção para transporte.
- 10 Nunca pouse a máquina com o motor em funcionamento sem que a tenha bem vigiada.



ATENÇÃO! Nem o utilizador da máquina nem qualquer outra pessoa deverão tentar afastar o material cortado enquanto o motor ou o equipamento de corte estiverem a rodar, dado que isso pode provocar graves ferimentos.

Faça parar o motor e o equipamento de corte antes de remover o material enrolado à volta do eixo da lâmina, caso contrário incorre-se no risco de ferimentos graves. A engrenagem angular pode estar quente durante e algum tempo depois do uso. Risco de queimaduras em caso de contacto directo.



ATENÇÃO! Cuidado com material arremessado. Use sempre protecção aprovada para os olhos. Nunca se incline sobre a protecção do equipamento de corte. Pedras, lixo, etc., podem ser projectados contra os olhos e causar cegueira ou ferimentos graves.

Mantenha estranhos ao trabalho afastados. Crianças, animais, espectadores e ajudantes deverão ficar fora da zona de segurança de 15 metros. Pare a máquina imediatamente se alguém se aproximar. Nunca balance a máquina em sua volta sem verificar se alguém se encontra atrás de si ou na zona de segurança.

Técnicas básicas de trabalho

Deixe o motor baixar para a marcha em vazio após cada momento de trabalho. Aceleração total por muito tempo, sem carga para o motor pode causar sérios danos ao motor.



ATENÇÃO! Por vezes prendem-se ramos ou galhos e erva entre a protecção e o equipamento de corte. Pare sempre o motor para efectuar a limpeza.

TÉCNICA DE TRABALHO



ATENÇÃO! As máquinas equipadas com lâminas de serra ou lâminas para a relva podem ser projectadas violentamente para o lado quando a lâmina entra em contacto com um objecto fixo. Isto chama-se arremesso da lâmina. O arremesso da lâmina pode ser suficientemente violento para projectar a máquina e/ou o operador em qualquer direcção e, eventualmente, perder o controlo sobre a máquina. O arremesso da lâmina pode ocorrer sem aviso prévio se a máquina bater em tronco oculto, emperrar ou ficar entalada. A ocorrência de arremesso da lâmina é mais provável em áreas onde é difícil ver o material que está a ser cortado.

Evite serrar no quadrante superior direito da lâmina. Devido à rotação da lâmina, poderá ocorrer um retrocesso justamente nesta área da lâmina, quando o contacto se faz com troncos mais grossos.

Roçar relva com a lâmina para erva



- Lâminas e facas para erva nunca devem ser usadas para caules lenhosos.
- Para todos os tipos de erva alta e espessa, usa-se a lâmina para erva.
- A relva é roçada com um movimento pendular lateral, em que o movimento da direita para a esquerda é a fase de roçar e o movimento da esquerda para a direita o retorno. Deixe a lâmina trabalhar com o lado esquerdo (entre as posições correspondentes às 8h e meio dia dos ponteiros do relógio).

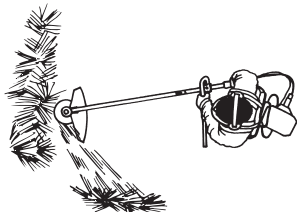

- Se inclinar a lâmina um pouco para a esquerda ao roçar, a relva acumula-se numa linha, facilitando a recolha, p. ex. com o ancinho.
- Procure trabalhar ritmicamente. Esteja bem plantado, com os pés afastados. Mova-se para a frente depois do movimento de retorno e fique bem plantado outra vez.
- Deixe o copo de apoio tocar levemente no solo. Assim protege a lâmina contra o contacto com o solo.

- Reduza o risco de se enroscar erva na lâmina, seguindo as regras seguintes:

1 Trabalhe sempre com aceleração total.

2 Evite a erva recém-cortada no movimento de retorno.

- Pare o motor, desprenda a correia de suporte e coloque a máquina no chão antes de recolher o material cortado.

Recorte de relva com o cabeçote de recorte



Recorte

- Mantenha o cabeçote de recorte um pouco acima do solo e incline-o angularmente. É a extremidade da corda que executa o trabalho. Deixe a corda trabalhar no seu próprio ritmo. Nunca pressione a corda contra materiais a serem removidos.



- A corda remove facilmente relva e ervas daninhas junto a paredes, vedações, árvores e canteiros mas também pode danificar cascas de árvores e arbustos sensíveis, bem como as estacas das vedações.
- Diminua o risco de danos à vegetação, encurtando para 10-12 cm a corda e reduzindo a rotação do motor.

Raspagem

- A técnica de raspagem remove toda a vegetação indesejável. Mantenha o cabeçote de recorte um pouco acima do solo e incline-o. Deixe a extremidade da corda tocar o solo à volta das árvores, estacas, estátuas, etc. **NOTA!** Esta técnica aumenta o desgaste das cordas.



- A corda desgasta-se mais rapidamente e tem de ser alimentada mais frequentemente em trabalhos contra pedras, tijolos, betão, vedações de metal, etc., do que em contacto com árvores e vedações de madeira.
- Ao recortar e raspar use aceleração menor que a total para que a corda dure mais e o cabeçote de recorte sofra menos desgaste.

Corte

- A recortadora é ideal para cortar relva em lugares de difícil acesso para o cortador de relva comum. Mantenha a corda paralela ao solo ao cortar. Evite

TÉCNICA DE TRABALHO

pressionar o cabeçote de recorte contra o solo já que isto poderá danificar o relvado e a alfaia.

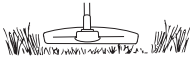

- Evite que o cabeçote de recorte tenha contacto permanente com o solo durante um corte normal. Tal procedimento pode causar danos e desgaste no cabeçote de recorte.

Varredura

- A acção de sopro da corda a girar pode ser utilizada para uma rápida e simples limpeza. Mantenha a corda paralela e acima da superfície a varrer e movimente a alfaia para a frente e para trás.

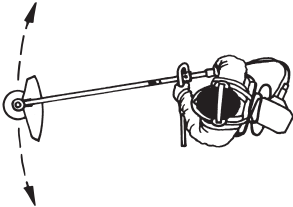

- Ao cortar e varrer, use aceleração total para um bom resultado.

KEES VAN DER SPEK
TUINMACHINES ★ STOLWIJK

Carburador

Ajustamento da marcha em vazio (T)

Verifique se o filtro do ar está limpo. O equipamento de corte não deve rodar quando a marcha em vazio está correctamente ajustada. Se for necessário afinar, feche (no sentido horário) o parafuso T, com o motor a funcionar, até o equipamento de corte começar a girar. Abra (no sentido anti-horário) o parafuso até o equipamento de corte parar. A rotação correcta na marcha em vazio é atingida quando o motor funcionar regularmente em todas as posições, com boa margem até à rotação em que o equipamento de corte começa a girar..

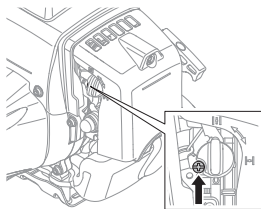

ATENÇÃO! Se não for possível ajustar a rotação na marcha em vazio, de modo a que o equipamento de corte pare, entre em contacto com o seu revendedor ou oficina autorizada. Não utilize a máquina até esta estar correctamente regulada ou devidamente reparada.

Filtro de ar



O filtro de ar deve ser limpo regularmente, removendo-se poeira e sujidades de modo a evitar:

- Distúrbios no carburador
- Problemas de arranque
- Diminuição de potência
- Desgaste inútil das peças do motor.
- Consumo de combustível fora do normal.

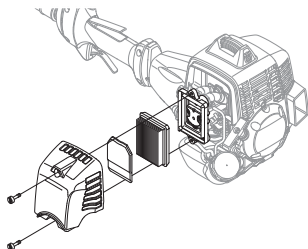

Limpe o filtro após 25 horas de funcionamento ou mais frequentemente em ambientes de muita poeira.

Limpeza do filtro de ar

Desmonte a cobertura do filtro de ar e remova o filtro. Lave-o bem com água quente e sabão. O filtro deverá estar seco ao montar novamente no lugar.

Um filtro de ar usado por longo tempo nunca pode ficar completamente limpo. Por isso o filtro deve, a intervalos regulares, ser trocado por um novo. **Um filtro danificado deve sempre ser substituído.**

Filtro de combustível

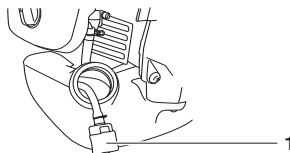

1 Filtro de combustível

Se a alimentação de combustível ao motor falhar, verifique a tampa do reservatório e o filtro do combustível, para verificar se há bloqueios.

Engrenagem angular



A engrenagem angular é lubrificada de fábrica com a quantidade de massa necessária. Antes da máquina entrar em funcionamento deve ser verificado se a engrenagem está cheia de massa a 3/4. Utilize a massa especial HUSQVARNA.

A massa lubrificante da caixa de engrenagens normalmente não necessita de ser substituída, a não ser no caso de eventuais reparações.

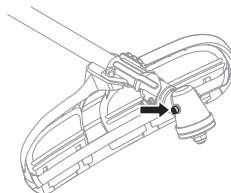

Vela de ignição



O funcionamento da vela de ignição é sensível a:

- Carburador incorrectamente regulado.
- Uma mistura incorrecta de óleo no combustível (óleo a mais ou de tipo errado).
- Filtro de ar sujo.

MANUTENÇÃO

Esses factores causam a formação de crostas nos eléctrodos da vela de ignição e podem ocasionar problemas no funcionamento e dificuldades em arrancar.

Se a potência da máquina for baixa, se for difícil de arrancar ou a marcha em vazio for inconstante: verifique sempre a vela de ignição, antes de tomar outras providências. Se a vela estiver suja, limpe-a e verifique se a folga entre os eléctrodos é de 0,6-0,7 mm. A vela de ignição deve ser trocada após um funcionamento de cerca de um mês ou mais cedo se necessário.

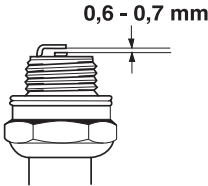

NOTA! Use sempre o tipo de vela de ignição recomendado! Uma vela de ignição incorrecta pode danificar o pistão/cilindro. Verifique se a vela de ignição não produz interferências de rádio.

Eixo motriz



O eixo-motor flexível é lubrificado com massa lubrificante para eixos-motores da Husqvarna. O eixo deve ser lubrificado pelo menos de 6 em 6 meses.

- Levante o freio que mantém a capa do eixo motriz na cobertura do acoplamento.

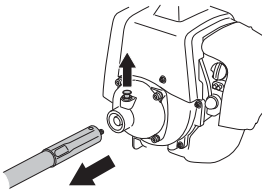

- Puxe a capa do eixo motriz para fora da cobertura do acoplamento.
- Extraia o eixo motriz da capa, sacudindo-o até sair ou puxando-o com um alicate.

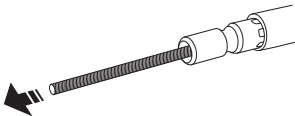

- Aplice massa lubrificante directamente da embalagem ao longo de todo o eixo. Espalhe com um pincel ou um pano.

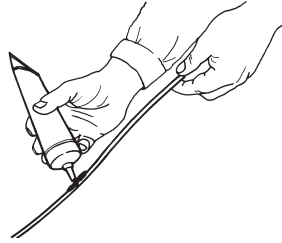

- Reponha o eixo na capa. Verifique se o eixo vai para a sua posição, girando-o ao mesmo tempo que o comprime para dentro.

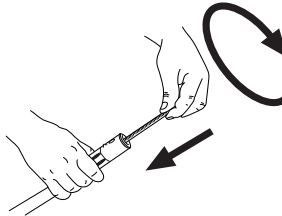

- Quando o eixo está montado correctamente na capa, a extremidade do eixo deve ficar cerca de 10 mm para fora do bordo da capa.

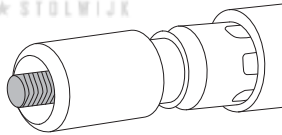

- Monte a capa do eixo motriz na cobertura do acoplamento de forma que o furo fique centrado com o freio na cobertura do acoplamento.

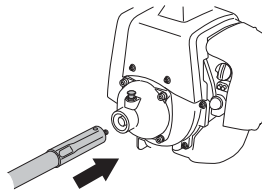

- Certifique-se de que o eixo está instalado correctamente, fazendo-o rodar e empurrando simultaneamente.

MANUTENÇÃO

Esquema de manutenção

Abaixo segue uma lista dos cuidados a ter com a máquina. A maioria dos pontos encontram-se descritos na secção Manutenção. O utente só pode efectuar trabalhos de manutenção e assistência do tipo descrito nestas instruções. Intervenções maiores devem ser efectuadas por uma oficina autorizada.

Manutenção	Controle diário	Controle semanal	Controle mensal
Limpe a máquina externamente.	X		
Verifique se a correia de suporte está intacta.	X		
Verifique se o bloqueio do acelerador e se o acelerador funcionam com segurança.	X		
Verifique se o punho e a direcção estão completos e devidamente fixos.	X		
Verifique se o contacto de paragem funciona.	X		
Verifique se o equipamento de corte não gira na marcha em vazio.	X		
Limpe o filtro de ar. Troque se necessário.	X		
Verifique se a protecção está em bom estado e sem rachaduras. Troque a protecção se esta foi sujeita a golpes ou se tem rachaduras.	X		
Verifique se a lâmina está bem centrada, bem afiada e não apresenta rachaduras. Uma lâmina descentrada causa vibrações que podem danificar a máquina.	X		
Verifique se o cabeçote de recorte está intacto e não apresenta rachaduras. Substitua o cabeçote de recorte se necessário.	X		
Verifique se o parafuso de bloqueio do equipamento de corte está correctamente apertado.	X		
Verifique se a protecção para transporte da lâmina está completa e se pode ser devidamente fixada.	X		
Verifique se os parafusos e porcas estão apertados.	X		
Verifique se não há fuga de combustível do motor, depósito ou tubagem de combustível.	X		
Verifique o dispositivo de arranque e a sua corda.		X	
Verifique se os isoladores de vibração estão danificados.		X	
Limpe a vela de ignição por fora. Desmonte e controle a distância entre os eléctrodos. Ajuste a distância para 0,6-0,7 mm ou substitua a vela de ignição. Verifique se a vela de ignição não produz interferências de rádio.		X	
Limpe o sistema de arrefecimento da máquina.		X	
Limpe o carburador exteriormente e o espaço à volta deste.		X	
Verifique se a engrenagem angular está cheia de massa lubrificante a 3/4. Ateste com massa especial se necessário.		X	
Limpe o silenciador.			X
Verifique se o filtro de combustível não está sujo e se o tubo de combustível não está gretado nem tem outros defeitos. Se necessário substituir.			X
Verifique todos os cabos e conexões.			X
Verifique a embraiagem, as molas da embraiagem e o tambor de acoplamento com vista a desgaste. Se necessário, substituir as peças numa oficina autorizada.			X
Substitua a vela de ignição. Verifique se a vela de ignição não produz interferências de rádio.			X
Lubrifique o eixo-motor com a massa especial Husqvarna para eixos-motores.	Faça-o todos os seis meses.		

ESPECIFICAÇÕES TÉCNICAS

Especificações técnicas

	553RBX
Motor	
Cilindrada, cm ³	50,6
Diâmetro do cilindro, mm	45,5
Curso do pistão, mm	31,1
Rotação em vazio, r/min.	2800
Rotação máxima recomendada, r/min.	13000
Rotação no eixo de saída, rpm	9285
Potência máx. do motor, de acordo com a ISO 8893, kW/ r/min	2,3/9500
Silenciador com catalisador	Não
Sistema de ignição	
Vela de ignição	NGK CMR7H
Folga dos eléctrodos, mm	0,6-0,7
Sistema de combustível/lubrificação	
Capacidade do depósito, litros	0,8
Peso	
Peso sem combustível, equipamento de corte e protecção, kg	12,1
Emissões de ruído	
(ver nota 1)	
Nível de potência sonora, medido em dB(A)	117
Nível de potência sonora, L _{WA} garantido dB(A)	118
Níveis sonoros	
(ver nota 2)	
Nível de pressão sonora equivalente, junto do ouvido do utente, medido conforme EN ISO 11806 e ISO 22868, dB(A)	
Equipado com cabeçote de recorte (original)	97
Equipado com lâmina de relva (original)	97
Níveis de vibração	
(ver nota 3)	
Níveis de vibração equivalente (a _{hw,eq}) nos punhos, medidos de acordo com a norma EN ISO 11806 e ISO 22867, m/s ²	
Equipado com cabeçote de recorte (original), esquerda/direita	2,7/3,3
Equipado com lâmina de relva (original), esquerda/direita	2,7/3,8
Nota 1: Emissões sonoras para as imediações, medidas sob forma de potência sonora (L _{WA}) conforme a directiva da CE 2000/14/CE. O nível de potência sonora registado para a máquina foi medido com o equipamento de corte original que debita o nível mais alto. A diferença entre a potência sonora garantida e medida é que a potência sonora garantida inclui também a dispersão no resultado da medição e as variações entre diferentes máquinas do mesmo modelo, de acordo com a Directiva 2000/14/CE.	
Nota 2: Os dados registados para o nível de pressão de ruído equivalente para a máquina tem uma dispersão estatística típica (desvio padrão) de 1 dB (A).	
Nota 3: Os dados registados para o nível de vibração equivalente têm uma dispersão estatística típica (desvio padrão) de 1 m/s ²	

ESPECIFICAÇÕES TÉCNICAS

Acessórios aprovados	Tipo	Protecção para equipamento de corte, Art. nº
Lâmina para erva/faca para erva	Multi 300-3 (Ø 300 3-dentes)	537 33 16-03
	Multi 275-4 (Ø 275 4-dentes)	537 33 16-03
Cabeçote de recorte	T45x (corda Ø 2,7 - 3,3 mm)	537 33 16-03
	T55x (corda Ø 2,7 - 3,3 mm)	537 33 16-03
Copo de apoio	Fixo	-

Certificado CE de conformidade (Válido unicamente na Europa)

Nós, **Husqvarna AB**, SE-561 82 Huskvarna, Suécia, telefone nº +46-36-146500, declaramos ser de nossa inteira responsabilidade que os produtos roçador **Husqvarna 553RBX** a que se refere esta declaração, com números de série do ano de 2012 e seguintes (o ano é claramente identificado na etiqueta de tipo, seguido de um número de série) está conforme a DIRECTRIZ DO CONSELHO a seguir mencionada:

- de 17 de Maio de 2006 "referente a máquinas" **2006/42/CE**
- de 15 de Dezembro de 2004 "referente a compatibilidade electromagnética" **2004/108/CEE**.
- de 8 de Maio de 2000 "referente à emissões sonoras para as imediações" **2000/14/CE**. Avaliação de conformidade efectuada de acordo com as disposições do Anexo V. Para informações referentes às emissões sonoras, ver o capítulo Especificações técnicas.

Foram respeitadas as normas seguintes: **EN ISO 12100:2010, CISPR 12:2007, ISO 14865:1998**.

O controle de tipo, facultativo, foi efectuada por SMP Svensk Maskinprovning AB, Fyrisborgsgatan 3, SE-754 50 Uppsala, Suécia por incumbência de Husqvarna AB.

O certificado tem o número: **SEC/12/2344**

Huskvarna, 8 de Fevereiro de 2012

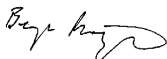

KEES VAN DER SPEK
TUINMACHINES * STOLWIJK

Bengt Frögelius, Chefe de Desenvolvimento (Representante autorizado da Husqvarna AB e responsável pela documentação técnica.)

ACLARACIÓN DE LOS SÍMBOLOS

Símbolos

¡ATENCIÓN! Una desbrozadora, quita arbustos o recortadora puede ser una herramienta peligrosa si se utiliza de manera errónea o descuidada, y provocar heridas graves o mortales al usuario o terceros. Es sumamente importante que lea y comprenda el contenido de este manual de instrucciones.

Lea detenidamente el manual de instrucciones y asegúrese de entender su contenido antes de utilizar la máquina.

Utilice siempre:

- Casco protector cuando existiera el riesgo de objetos que caen
- Protectores auriculares homologados
- Protección ocular homologada

Velocidad máxima en el eje de salida, rpm

Este producto cumple con la directiva CE vigente.

Cuidado con los objetos lanzados o rebotados.

Durante el trabajo, el usuario de la máquina debe procurar que ninguna persona o animal se acerque a más de 15 metros a la máquina.

Las máquinas equipadas con hojas de sierra u hojas para hierba pueden ser despedidas violentamente hacia un lado cuando la hoja entra en contacto con un objeto fijo. A este efecto se le llama lanzada de hoja. La hoja puede amputar un brazo o una pierna. Mantener siempre a las personas y animales a como mínimo 15 metros de distancia de la máquina.

Marcas de flechas que indican los límites para colocar la sujeción del mango.

Encendido; estrangulador: Ponga el estrangulador en la posición de estrangulamiento. Entonces, el botón de parada se desplazará automáticamente hacia la posición de arranque.

Bomba de combustible.



Utilice siempre guantes protectores homologados.

Utilice botas antideslizantes y seguras.

Indicado únicamente para equipo de corte flexible, no metálico, es decir cabezal de corte con hilo de corte.

Las emisiones sonoras en el entorno según la directiva de la Comunidad Europea. Las emisiones de la máquina se indican en el capítulo Datos técnicos y en la etiqueta.

Mantenga todas las partes de su cuerpo apartadas de las superficies calientes.

Los demás símbolos/etiquetas que aparecen en la máquina corresponden a requisitos de homologación específicos en determinados mercados.

Los controles y/o mantenimiento deben efectuarse con el motor parado, con el botón de parada en la posición STOP.

Utilice siempre guantes protectores homologados.

La máquina debe limpiarse regularmente.

Control visual.



Índice

ACLARACIÓN DE LOS SÍMBOLOS

Símbolos 130

ÍNDICE

Índice 131

Antes de arrancar, observe lo siguiente: 131

INTRODUCCIÓN

Apreciado cliente: 132

¿QUÉ ES QUÉ?

¿Qué es qué en la desbrozadora? 133

INSTRUCCIONES GENERALES DE SEGURIDAD

Importante 134

Equipo de protección personal 134

Equipo de seguridad de la máquina 135

Equipo de corte 138

MONTAJE

Montaje del eje propulsor flexible 140

Conexión del cable de acelerador y los hilos del interruptor de parada 140

Montaje del mango J 140

Montaje de la hoja y del cabezal de corte 141

Montaje de la protección para transportes 142

Ajuste del arnés y la desbrozadora 142

MANIPULACION DEL COMBUSTIBLE

Seguridad en el uso del combustible 144

Carburante 144

Repostaje 145

ARRANQUE Y PARADA

Control antes de arrancar 146

Arranque y parada 146

TÉCNICA DE TRABAJO

Instrucciones generales de trabajo 148

MANTENIMIENTO

Carburador 151

Filtro de aire 151

Filtro de combustible 151

Engranaje angulado 151

Bujía 151

Eje propulsor 152

Programa de mantenimiento 153

DATOS TÉCNICOS

Datos técnicos 154

Declaración CE de conformidad 155

Antes de arrancar, observe lo siguiente:

Lea detenidamente el manual de instrucciones.



¡ATENCIÓN! La exposición prolongada al ruido puede causar daños crónicos en el oído. Por consiguiente, use siempre protectores auriculares homologados.



¡ATENCIÓN! Bajo ninguna circunstancia debe modificarse la configuración original de la máquina sin autorización del fabricante. Utilizar siempre recambios originales. Las modificaciones y/o la utilización de accesorios no autorizadas pueden ocasionar accidentes graves o incluso la muerte del operador o de terceros.



¡ATENCIÓN! Una desbrozadora, quita arbustos o recortadora puede ser una herramienta peligrosa si se utiliza de manera errónea o descuidada, y provocar heridas graves o mortales al usuario o terceros. Es sumamente importante que lea y comprenda el contenido de este manual de instrucciones.

INTRODUCCIÓN

Apreciado cliente:

¡Felicidades por haber adquirido un producto Husqvarna! La historia de Husqvarna data del año 1689, cuando el Rey Karl XI encargó la construcción de una fábrica en la ribera del río Huskvarna para la fabricación de mosquetes. La ubicación junto al río Huskvarna era lógica dado que el río se utilizaba para generar energía hidráulica. Durante los más de 300 años de existencia de la fábrica Husqvarna, se han fabricado productos innumerables; desde estufas de leña hasta modernas máquinas de cocina, máquinas de coser, bicicletas, motocicletas, etc. En 1956 se introdujo el primer cortacésped motorizado, seguido de la motosierra en 1959; y es en este segmento en el que actualmente trabaja Husqvarna.

Husqvarna es hoy uno de los principales fabricantes del mundo de productos de bosque y jardín, con la calidad y las prestaciones como principal prioridad. La idea de negocio es desarrollar, fabricar y comercializar productos motorizados para silvicultura y jardinería, así como para las industrias de construcción y obras públicas. Husqvarna tiene como objetivo estar en la vanguardia por lo que respecta a ergonomía, facilidad de empleo, seguridad y consideración ambiental; motivo por el cual ha desarrollado una serie de detalles para mejorar los productos en estas áreas.

Estamos convencidos de que usted apreciará con satisfacción la calidad y prestaciones de nuestro producto por mucho tiempo en adelante. Con la adquisición de alguno de nuestros productos, usted dispone de asistencia profesional con reparaciones y servicio en caso de ocurrir algo. Si ha adquirido el producto en un punto de compra que no es uno de nuestros concesionarios autorizados, pregúnteles por el taller de servicio más cercano.

Esperamos que su máquina le proporcione plena satisfacción y le sirva de ayuda por mucho tiempo en adelante. Tenga en cuenta que este manual de instrucciones es un documento de valor. Siguiendo sus instrucciones (de uso, servicio, mantenimiento, etcétera) puede alargar considerablemente la vida útil de la máquina e incrementar su valor de reventa. Si vende su máquina, entregue el manual de instrucciones al nuevo propietario.

¡Gracias por utilizar un producto Husqvarna!

Husqvarna AB trabaja constantemente para perfeccionar sus productos y se reserva, por lo tanto, el derecho a introducir modificaciones en la construcción y el diseño sin previo aviso.

KEES VAN DER SPEK
TUINMACHINES ★ STOLWIJK

¿QUÉ ES QUÉ?

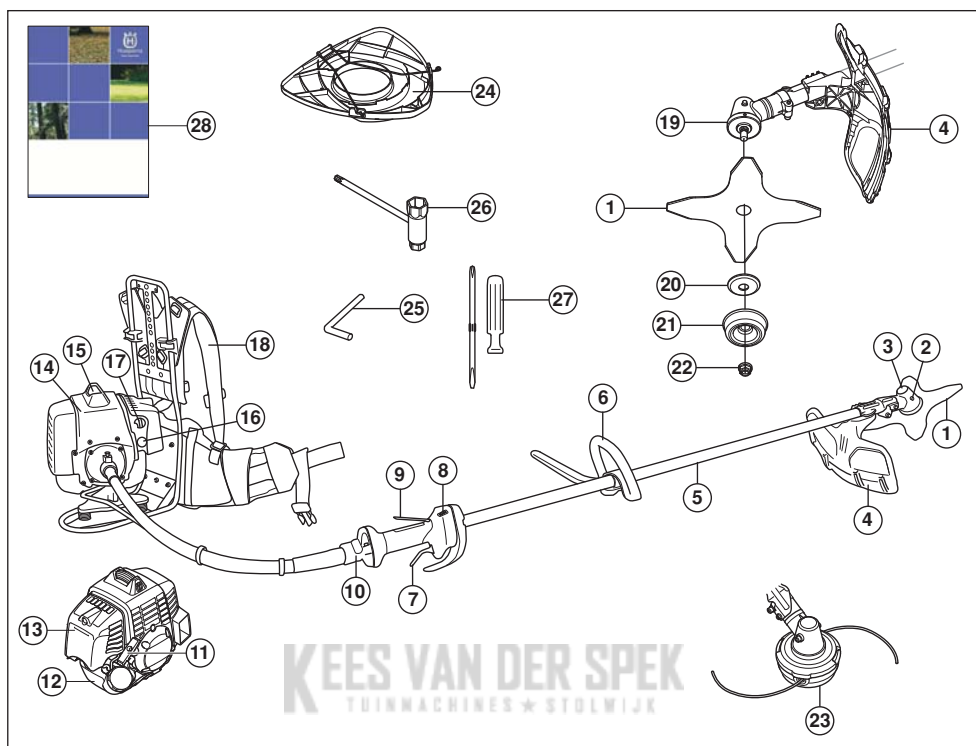

¿Qué es qué en la desbrozadora?

- | | |
|---|----------------------------------|
| 1 Hoja | 15 Capuchón de encendido y bujía |
| 2 Recarga de lubricante, engranaje angulado | 16 Bomba de combustible. |
| 3 Engranaje angulado | 17 Estrangulador |
| 4 Protección del equipo de corte | 18 Arnés |
| 5 Tubo | 19 Pieza de arrastre |
| 6 Mango cerrado | 20 Brida de apoyo |
| 7 Acelerador | 21 Cazoleta de apoyo |
| 8 Botón de parada | 22 Contratuerca |
| 9 Fiador del acelerador | 23 Cabezal de corte |
| 10 Acoplamiento del tubo | 24 Protección para transportes |
| 11 Empuñadura de arranque | 25 Pasador de seguridad |
| 12 Depósito de combustible | 26 Llave de la tuerca de hoja |
| 13 Cubierta del filtro de aire | 27 Destornillador |
| 14 Cubierta del cilindro | 28 Manual de instrucciones |

INSTRUCCIONES GENERALES DE SEGURIDAD

Importante

¡IMPORTANTE!

La máquina está destinada únicamente al corte de hierba y el desbroce de hierba.

Los únicos accesorios que Ud. puede acoplar al motor como fuente propulsora son los equipos de corte que nosotros recomendamos en el capítulo Datos técnicos.

Nunca utilice la máquina si está cansado, si ha ingerido alcohol o si toma medicamentos que puedan afectarle la vista, su capacidad de discernimiento o el control del cuerpo.

Utilice el equipo de protección personal. Vea las instrucciones bajo el título "Equipo de protección personal".

No utilice nunca una máquina que haya sido modificada de modo que ya no coincida con la configuración original.

No utilice nunca una máquina defectuosa. Siga las instrucciones de mantenimiento, control y servicio de este manual. Algunas medidas de mantenimiento y servicio deben ser efectuadas por especialistas formados y cualificados. Vea las instrucciones bajo el título Mantenimiento.

Todas las tapas, protecciones y empuñaduras deben estar montadas antes de arrancar la máquina. Comprobar que el sombrerete de la bujía y el cable de encendido están en perfecto estado para evitar el riesgo de sacudida eléctrica.

El usuario de la máquina debe asegurarse de que ninguna persona o animal se acerquen más de 15 metros durante el trabajo. Si varios usuarios trabajan en el mismo lugar, la distancia de seguridad debe equivaler, por lo menos, a dos longitudes de árbol, pero nunca ser menor de 15 metros.



¡ATENCIÓN! Esta máquina genera un campo electromagnético durante el funcionamiento. Este campo magnético puede, en determinadas circunstancias, interferir con implantes médicos activos o pasivos. Para reducir el riesgo de lesiones graves o letales, las personas que utilizan implantes médicos deben consultar a su médico y al fabricante del implante antes de emplear esta máquina.



¡ATENCIÓN! Si se hace funcionar el motor en un local cerrado o mal ventilado, se corre riesgo de muerte por asfixia o intoxicación con monóxido de carbono.



¡ATENCIÓN! No permita nunca que los niños utilicen la máquina ni permanezcan cerca de ella. Dado que la máquina tiene un contacto de parada con retorno por muelle y puede arrancar con poca velocidad y fuerza en la empuñadura de arranque, incluso niños pequeños pueden, en determinadas circunstancias, lograr la fuerza necesaria para arrancar la máquina. Ello puede comportar riesgo de daños personales graves. Por consiguiente, saque el capuchón de encendido cuando va a dejar la máquina sin vigilar.

Equipo de protección personal

¡IMPORTANTE!

Una desbrozadora, quita arbustos o recortadora puede ser una herramienta peligrosa si se utiliza de manera errónea o descuidada, y provocar heridas graves o mortales al usuario o terceros. Es sumamente importante que lea y comprenda el contenido de este manual de instrucciones.

Para trabajar con la máquina debe utilizarse un equipo de protección personal homologado. El equipo de protección personal no elimina el riesgo de lesiones, pero reduce su efecto en caso de accidente. Pida a su distribuidor que le asesore en la elección del equipo.



¡ATENCIÓN! Cuando use protección auditiva preste siempre atención a las señales o llamados de advertencia. Sáquese siempre la protección auditiva inmediatamente después de parar el motor.

CASCO

Casco protector cuando exista el riesgo de objetos que caen



PROTECCIÓN AUDITIVA

Se debe utilizar protección auditiva con suficiente capacidad de reducción sonora.



INSTRUCCIONES GENERALES DE SEGURIDAD

PROTECCIÓN OCULAR

Se debe utilizar siempre protección ocular homologada. Si se utiliza visor, deben utilizarse también gafas protectoras homologadas. Por gafas protectoras homologadas se entienden las que cumplen con la norma ANSI Z87.1 para EE.UU. o EN 166 para países de la UE.



GUANTES

Se deben utilizar guantes cuando sea necesario, por ejemplo al montar el equipo de corte.



BOTAS

Utilice botas antideslizantes y seguras.



VESTIMENTA

Use ropas de material resistente a los desgarros y no demasiado amplias para evitar que se enganchen en ramas, etc. Use siempre pantalones largos gruesos. No trabaje con joyas, pantalones cortos, sandalias ni los pies descalzos. No lleve el cabello suelto por debajo de los hombros.

PRIMEROS AUXILIOS

Tenga siempre a mano el equipo de primeros auxilios.



Equipo de seguridad de la máquina

En este capítulo se describen los componentes de seguridad de la máquina, su función y el modo de efectuar el control y el mantenimiento para garantizar un funcionamiento óptimo. En cuanto a la ubicación de estos componentes en su máquina, vea el capítulo Qué es qué.

La vida útil de la máquina puede acortarse y el riesgo de accidentes puede aumentar si el mantenimiento de la máquina no se hace de forma adecuada y si los trabajos de servicio y/o reparación no se efectúan de forma profesional. Para más información, consulte con el taller de servicio oficial más cercano.

¡IMPORTANTE! Todos los trabajos de servicio y reparación de la máquina requieren una formación especial. Esto es especialmente importante para el equipo de seguridad de la máquina. Si la máquina no pasa alguno de los controles indicados a continuación, acuda a su taller de servicio local. La compra de alguno de nuestros productos le garantiza que puede recibir un mantenimiento y servicio profesional. Si no ha adquirido la máquina en una de nuestras tiendas especializadas con servicio, solicite información sobre el taller de servicio más cercano.



¡ATENCIÓN! Nunca utilice una máquina que tenga un equipo de seguridad defectuoso. Efectúe el control y mantenimiento del equipo de seguridad de la máquina como se describió en este capítulo. Si su máquina no pasa todos los controles, entréguela a un taller de servicio para su reparación.

Fiador del acelerador

El fiador del acelerador está diseñado para impedir la activación involuntaria del acelerador. Cuando se oprime el fiador (A) en el mango (= cuando se agarra el mango), se desacopla el acelerador (B). Cuando se suelta el mango, el acelerador y el fiador vuelven a sus posiciones originales. Ambas funciones se efectúan con sistemas independientes de muelles de retorno. Con esta posición, el acelerador queda automáticamente bloqueado en ralentí.

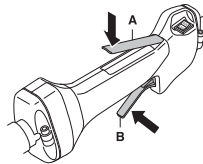

Compruebe que el acelerador esté bloqueado en la posición de ralentí cuando el fiador está en su posición inicial.

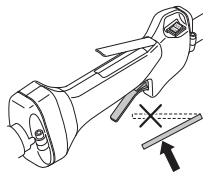

INSTRUCCIONES GENERALES DE SEGURIDAD

Apriete el fiador del acelerador y compruebe que vuelva a su posición de partida al soltarlo.

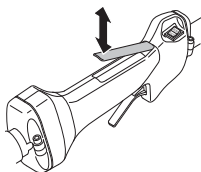

Compruebe que el acelerador y el fiador se muevan con facilidad y que funcionen sus muelles de retorno.

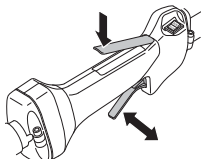

Consulte las instrucciones bajo el título Arranque. Ponga en marcha la máquina y acelere al máximo. Suelte el acelerador y controle que el equipo de corte se detenga y permanezca inmóvil. Si el equipo de corte gira con el acelerador en ralentí, se debe controlar la regulación del carburador para ralentí. Consulte las instrucciones bajo el título Mantenimiento.

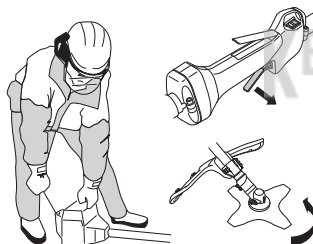

Botón de parada

El botón de parada se utiliza para parar el motor.

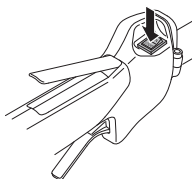

Arranque el motor y compruebe que se pare cuando se mueve el botón de parada a la posición de parada.

Protección del equipo de corte

Esta protección tiene por fin evitar que el usuario reciba el impacto de objetos desprendidos. La protección evita

también que el usuario entre en contacto con el equipo de corte.

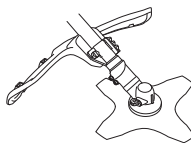

Controle que la protección no esté dañada y que no tenga grietas. Cambie la protección si ha estado expuesta a golpes o si tiene grietas.

Utilice siempre la protección recomendada para cada equipo de corte en particular. Consulte el capítulo Datos técnicos.



¡ATENCIÓN! Bajo ninguna circunstancia se puede utilizar un equipo de corte sin haber montado antes la protección recomendada. Consultar el capítulo Datos técnicos. Si se monta una protección incorrecta o defectuosa, esto puede causar daños personales graves.

Sistema amortiguador de vibraciones



Su máquina incorpora un sistema amortiguador diseñado para reducir al máximo posible las vibraciones y optimizar la comodidad de uso.

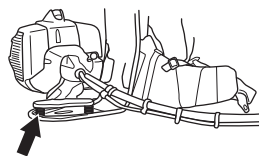

El uso de un hilo mal enrollado o de un equipo de corte roto o incorrecto (para más información sobre el tipo incorrecto o mal afilado, consulte las instrucciones bajo el título Afilado de la hoja) aumenta el nivel de vibraciones.

El sistema amortiguador de vibraciones de la máquina reduce la transmisión de vibraciones entre la parte del motor/equipo de corte y la parte de los mangos de la máquina.

Compruebe regularmente que los elementos antivibraciones no estén agrietados o deformados. Controle que los amortiguadores de vibraciones estén enteros y bien sujetos.

INSTRUCCIONES GENERALES DE SEGURIDAD



¡ATENCIÓN! La sobreexposición a las vibraciones puede producir lesiones vasculares o nerviosas en personas que padecen de trastornos circulatorios. Si advierte síntomas que puedan relacionarse con la sobreexposición a las vibraciones, consulte a un médico. Ejemplos de estos síntomas son entumecimiento, falta de sensibilidad, "hormigueo", "puntadas", dolor, pérdida o reducción de la fuerza normal, cambios en el color o la superficie de la piel. Generalmente, estos síntomas se presentan en los dedos, las manos y las muñecas. El riesgo puede ser mayor a bajas temperaturas.

Silenciador

El silenciador está diseñado para reducir al máximo posible el nivel sonoro y para apartar los gases de escape del usuario. El silenciador con catalizador también está diseñado para reducir las sustancias nocivas en los gases de escape.

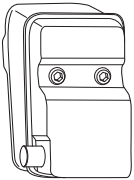

Nunca utilice una máquina que tenga un silenciador defectuoso.

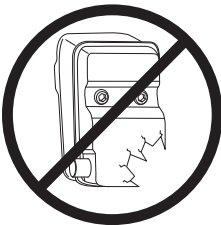

Compruebe regularmente que el silenciador esté firmemente montado en la máquina.

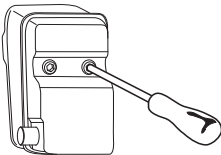

Si el silenciador de su máquina lleva rejilla apagachispas, límpiela a intervalos regulares. La obturación de la rejilla

produce el sobrecalentamiento del motor, con el riesgo consiguiente de averías graves.



¡ATENCIÓN! El silenciador con catalizador se calienta mucho durante el uso y permanece caliente aún luego de apagado el motor. Lo mismo rige para la marcha en ralentí. Su contacto puede quemar la piel. ¡Tenga en cuenta el peligro de incendio!



¡ATENCIÓN! En el interior del silenciador hay sustancias químicas que pueden ser cancerígenas. Evitar el contacto con estas sustancias si se daña el silenciador.



¡ATENCIÓN! Recuerde que: Los gases de escape del motor están calientes y pueden contener chispas que pueden provocar incendio. Por esa razón, ¡nunca arranque la máquina en interiores o cerca de material inflamable!

Contratuera

Para fijar determinados equipos de corte se utiliza una contratuera.



Para el montaje, apriete la tuerca girándola en sentido contrario al sentido de rotación del equipo de corte. Para el desmontaje, afloje la tuerca girándola en el sentido de rotación del equipo de corte. (NOTA: La tuerca tiene rosca a izquierdas.) Apriete la tuerca con la llave para tuerca de la hoja.

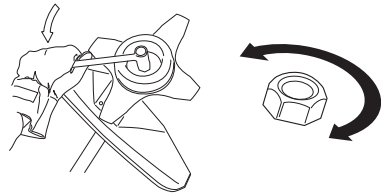

El bloqueo de nilón de la contratuera no debe estar tan gastado que se pueda apretar con los dedos. El bloqueo debe soportar por lo menos 1,5 Nm. La tuerca debe ser reemplazada luego de haberla apretado unas 10 veces.

INSTRUCCIONES GENERALES DE SEGURIDAD

Arnés



Controle que el arnés no esté dañado.

En caso de emergencia, suéltese de la máquina y del arnés siguiendo el procedimiento descrito a continuación.

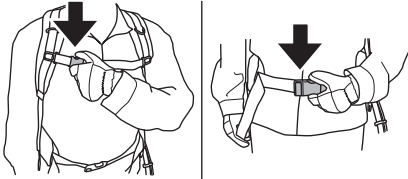

Equipo de corte

Este capítulo describe cómo Ud., con un mantenimiento correcto y utilizando el equipo de corte adecuado, podrá:

- Reducir la propensión a las reculadas de la máquina.
- Obtener un resultado de corte óptimo.
- Aumentar la duración del equipo de corte.

¡IMPORTANTE!

¡Utilice solamente el equipo de corte con la protección recomendada por nosotros! Consulte el capítulo Datos Técnicos.

Lea las instrucciones del equipo de corte para montar correctamente el hilo y elegir el diámetro de hilo correcto.

¡Mantenga los dientes de corte de la hoja afilados y en buen estado! Siga nuestras recomendaciones. Lea también las instrucciones en el envase de la hoja.



¡ATENCIÓN! Pare siempre el motor antes de trabajar con alguna parte del equipo de corte. Éste continúa girando incluso después de haber soltado el acelerador. Controle que el equipo de corte se haya detenido completamente y desconecte el cable de la bujía antes de comenzar a trabajar.



¡ATENCIÓN! Un equipo de corte defectuoso o una hoja mal afilada aumentan el riesgo de reculadas.

Equipo de corte

La hoja y la cuchilla para hierba están destinadas a desbrozar hierba más gruesa.

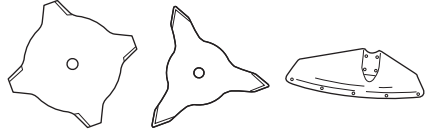

El cabezal de corte está destinado a recortar la hierba.



Reglas básicas



¡Utilice solamente el equipo de corte con la protección recomendada por nosotros! Consulte el capítulo Datos Técnicos.

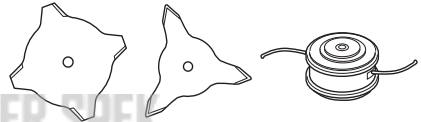

¡Mantenga los dientes de corte de la hoja afilados y en buen estado! Siga nuestras instrucciones y utilice el calibrador de limado recomendado. Una hoja mal afilada o dañada aumenta el peligro de accidentes.

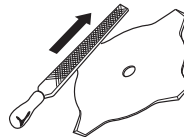

Revise el equipo de corte para ver si está dañado o agrietado. Un equipo de corte dañado debe ser siempre reemplazado.

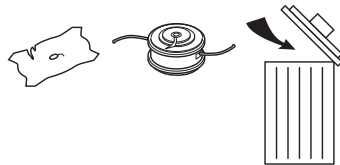

Afilado de la cuchilla y la hoja para hierba



- Para afilar correctamente el equipo de corte, lea las instrucciones en el envase. La hoja y la cuchilla se afilan con una lima plana de picadura sencilla.

INSTRUCCIONES GENERALES DE SEGURIDAD

- Lime todos los dientes por igual para conservar el equilibrio.

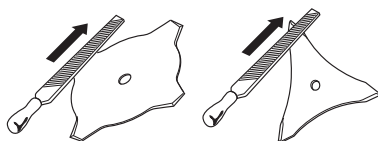

¡ATENCIÓN! Cambie siempre la hoja si la misma está doblada, torcida, agrietada, quebrada o dañada de algún otro modo. No trate nunca de enderezar una hoja torcida para volver a utilizarla. Utilice únicamente hojas originales del tipo recomendado.

Cabezal de corte

¡IMPORTANTE!

Observe siempre que el hilo de corte esté arrollado en forma firme y uniforme al rodillo, de lo contrario la máquina producirá vibraciones perjudiciales para la salud.

- Utilice únicamente los cabezales e hilos de corte recomendados. Han sido probados por el fabricante para un tamaño de motor especial. Esto es particularmente importante cuando se utiliza un cabezal de corte totalmente automático. Utilice únicamente el equipo de corte recomendado. Consulte el capítulo Datos Técnicos.



- En general, una máquina pequeña requiere un cabezal pequeño y viceversa. Esto se debe a que, al cortar con hilo, el motor debe lanzarlo radialmente hacia afuera desde el cabezal de corte y vencer la resistencia de la hierba que se va a cortar.
- El largo del hilo también es importante. Un hilo más largo requiere mayor potencia del motor que uno corto, con el mismo diámetro del hilo.
- Controle que el cuchillo que hay en la protección de la recortadora esté intacto. Se utiliza para cortar el hilo en el largo correcto.
- Para prolongar la vida útil del hilo, se puede poner en remojo un par de días. De esta manera el hilo se refuerza y dura más.

MONTAJE

Montaje del eje propulsor flexible

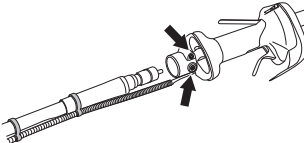

- Afloje dos tornillos del acoplamiento de eje.
- 
- Deslice el eje flexible a través de los lazos en el cableado y ajuste el eje flexible al acoplamiento de eje. Asegúrese de que el eje se acopla correctamente girándolo y empujándolo simultáneamente.
 - Apriete ambos tornillos.
 - Monte la carcasa del eje propulsor en la cubierta del embrague de manera que el orificio quede situado justamente debajo del botón de bloqueo de la cubierta del embrague.

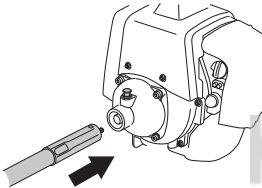

- Asegúrese de que el eje se acopla correctamente girándolo y empujándolo simultáneamente.
- Asegúrese de que el pasador de bloqueo vuelve a su posición inicial, de modo que el manguito del eje propulsor no pueda salirse del cárter de embrague.

Conexión del cable de acelerador y los hilos del interruptor de parada



- Coloque el cable del acelerador del cableado (A) y el cable del acelerador del motor (B) en el manguito de plástico, como muestra la imagen.

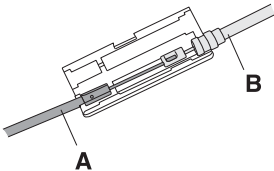

- Cierre el manguito de plástico.

- Conecte los cables del interruptor de parada en los conectores correspondientes del motor. Recuerde que la polaridad de los cables no es importante.

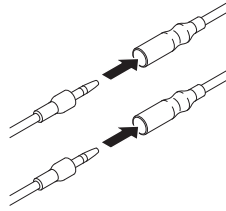

Montaje del mango J



- Coloque el mango contra el tubo. Preste atención a que el mango debe montarse debajo de la flecha en el tubo.

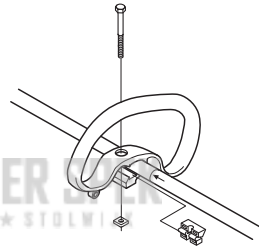

- Introducir el distanciador en la ranura del mango cerrado.
- Monte la tuerca y el tornillo. No los apriete demasiado.
- El mango J va montado en el mango cerrado con tres tornillos como muestra la figura.

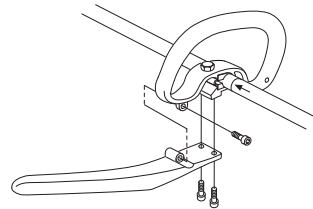

- Después, hacer un ajuste más exacto para obtener una posición de trabajo cómoda con la recortadora. Apretar el tornillo/la mariposa.

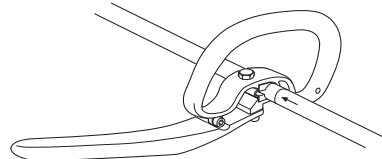

MONTAJE



¡ATENCIÓN! Al montar el mango J, deben utilizarse únicamente hojas/ cuchillas para hierba o cabezal de corte/ cuchillas de plástico. No utilizar nunca la hoja de sierra con el mango J.

Montaje de la hoja y del cabezal de corte



¡ATENCIÓN! Al montar el equipo de corte es sumamente importante que la guía de la pieza de arrastre/brida de apoyo quede bien colocada en el orificio central del equipo de corte. Un equipo de corte mal montado puede causar daños personales graves y/o mortales.

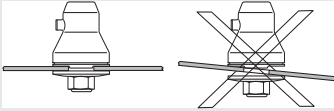

¡ATENCIÓN! Bajo ninguna circunstancia se puede utilizar un equipo de corte sin haber montado antes la protección recomendada. Consultar el capítulo Datos técnicos. Si se monta una protección incorrecta o defectuosa, esto puede causar daños personales graves.

¡IMPORTANTE! Para poder utilizar la hoja de sierra o de hierba, la máquina debe tener colocados el manillar, la protección de hoja y el arnés correctos.

Montaje del manto protector



¡NOTA! El manto protector debe estar siempre montado cuando se utiliza cabezal de recorte / cuchillas de plástico y protección combinada. Cuando se utiliza hoja para hierba y protección combinada, el manto protector debe estar desmontado.

La protección de la hoja/protección combinada (A) se engancha en la sujeción del tubo y se fija con un tornillo.

Introduzca la guía del manto protector en la ranura de la protección combinada. A continuación, fije el manto protector en la protección con los cuatro cierres rápidos.

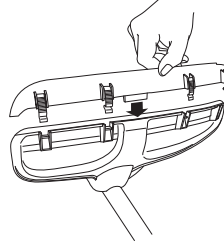

La extensión protectora se desmonta fácilmente con un destornillador; vea la figura.

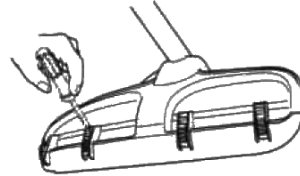

Montaje de la protección de hoja, hoja de hierba y cuchilla de hierba



- La protección de la hoja/protección combinada (A) se engancha en la sujeción del tubo y se fija con un tornillo (L). Utilice la protección de hoja recomendada. Vea el capítulo Datos técnicos. ¡NOTA! Compruebe que el manto protector está desmontado.

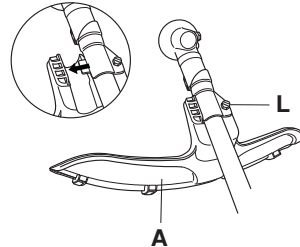

- Coloque la pieza de arrastre (B) en el eje de salida.
- Gire el eje de la hoja hasta que uno de los orificios de la pieza de arrastre coincida con un orificio de la caja de engranajes.
- Introduzca el pasador de seguridad (C) en el orificio para bloquear el eje.
- Coloque la hoja (D), la cazoleta de apoyo (E) y la brida de apoyo (F) en el eje de salida.
- Monte la tuerca (G). La tuerca debe apretarse con un par de 35-50 Nm (3,5-5 kpm). Utilice la llave tubular del juego de herramientas. Tome el mango de la llave

MONTAJE

lo más cerca posible de la protección de la hoja. La tuerca se aprieta girando la llave en sentido contrario a la rotación (NOTA: rosca izquierda).

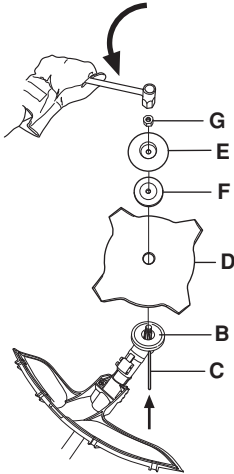

- Enrosque el cabezal de corte/las cuchillas de plástico (H) en el sentido contrario al de rotación.

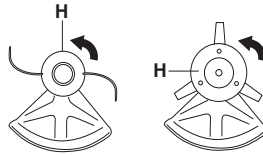

- El desmontaje se realiza en el orden inverso.

Montaje de la protección para transportes



- Introduzca el disco en el protector de transporte (A).
- Encaje los dos cierres (B) en las ranuras (C) para fijar el protector de transporte.

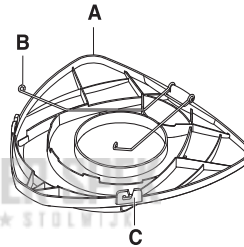

Ajuste del arnés y la desbrozadora



Ajuste de la altura de la placa de la espalda

- Suelte los dos cierres que sujetan la placa de la espalda.

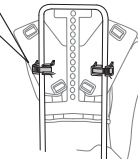
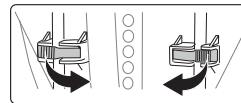

Montaje de la protección de la recortadora y el cabezal de corte



- Montar la protección de la recortadora (A) para trabajar con el cabezal de corte. ¡NOTA! Compruebe que el manto protector está montado.

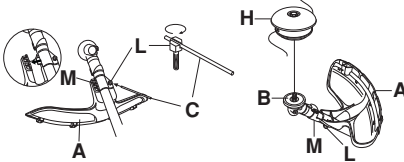

- La protección de la recortadora/protección combinada se engancha en la sujeción del tubo y se fija con un tornillo (L).
- Coloque la pieza de arrastre (B) en el eje de salida.
- Gire el eje de la hoja hasta que uno de los orificios de la pieza de arrastre coincida con un orificio de la caja de engranajes.
- Introduzca el pasador de seguridad (C) en el orificio para bloquear el eje.

MONTAJE

- Afloje la placa de la espalda del bastidor por un lado.

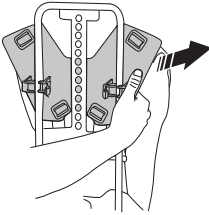

- Mueva la placa de la espalda hasta la altura deseada y apriétela. Asegúrese de que la clavija esté alineada con uno de los orificios del bastidor (consulte la imagen).

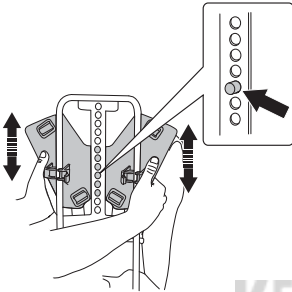

Ajuste del arnés

- Colóquese el arnés.
- Ajuste la correa de la cadera para que quede firme.



- Apriete la correa del pecho.



- Ajuste la correa del pecho verticalmente, si es necesario, y asegúrese de que se adapta bien.

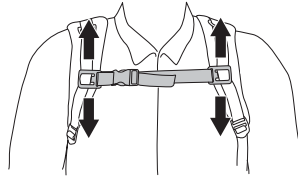

- Regule las correas portantes para que el peso se distribuya de forma pareja sobre los hombros.



- Afloje o apriete la correa de la cintura, de modo que aproximadamente el 70 % de la carga repose sobre su cintura y el 30 %, sobre sus hombros.

KEES VAN DER SPEK
TUINMACHINES * STOLWIJK

MANIPULACION DEL COMBUSTIBLE

Seguridad en el uso del combustible

Nunca arranque la máquina:

- 1 Si derramó combustible sobre la máquina. Seque cualquier residuo y espere a que se evaporen los restos de combustible.
- 2 Si se salpicó el cuerpo o las ropas, cambie de ropas. Lave las partes del cuerpo que han entrado en contacto con el combustible. Use agua y jabón.
- 3 Si hay fugas de combustible en la máquina. Compruebe regularmente si hay fugas en la tapa del depósito o en los conductos de combustible.

Transporte y almacenamiento

- Almacene y transporte la máquina y el combustible de manera que eventuales fugas o vapores no puedan entrar en contacto con chispas o llamas, por ejemplo, máquinas eléctricas, motores eléctricos, contactos eléctricos/interruptores de corriente o calderas.
- Para almacenar y transportar combustible se deben utilizar recipientes diseñados y homologados para tal efecto.
- Si la máquina se va a almacenar por un período largo, se debe vaciar el depósito de combustible. Pregunte en la estación de servicio más cercana qué hacer con el combustible sobrante.
- Antes del almacenaje prolongado, limpie bien la máquina y haga el servicio completo.
- La protección para transportes del equipo de corte siempre debe estar montada durante el transporte o almacenamiento de la máquina.
- Asegure la máquina durante el transporte.



¡ATENCIÓN! Sea cuidadoso al manejar el combustible. Piense en los riesgos de incendio, explosión e intoxicación respiratoria.

Carburante

¡NOTA! La máquina tiene un motor de dos tiempos, por lo que debe utilizarse siempre una mezcla de gasolina con aceite para motores de dos tiempos. Para obtener una mezcla con las proporciones correctas, debe medirse con precisión la cantidad de aceite que se mezclará. En la mezcla de pequeñas cantidades de combustible, los errores más insignificantes en la medición del aceite influyen considerablemente en las proporciones de la mezcla.



¡ATENCIÓN! El combustible y los vapores de combustible son muy inflamables y pueden causar daños graves por inhalación y contacto con la piel. Por consiguiente, al manipular combustible proceda con cuidado y procure que haya buena ventilación.

Gasolina



¡NOTA! Use siempre gasolina de buena calidad mezclada con aceite de como mínimo 90 octanos (RON). Si su máquina está equipada con catalizador (vea el capítulo Datos técnicos), debe usarse siempre gasolina sin plomo de buena calidad mezclada con aceite. La gasolina con plomo avería el catalizador.

Si hay disponible gasolina menos nociva para el medio ambiente, denominada gasolina de alquilato, se debe usar este tipo de gasolina.



- El octanaje mínimo recomendado es 90 (RON). Si se hace funcionar el motor con gasolina de octanaje inferior a 90, puede producirse clavazón. Esto aumenta la temperatura del motor, con el consiguiente riesgo de averías.
- Para trabajar durante mucho tiempo en altas revoluciones se recomienda el uso de gasolina con más octanos.

Aceite para motores de dos tiempos

- Para un resultado y prestaciones óptimos, utilice aceite para motores de dos tiempos HUSQVARNA, especialmente fabricado para motores de dos tiempos refrigerados por aire.
- No utilice nunca aceite para motores de dos tiempos fuera borda refrigerados por agua (llamado outboard oil), con designación TCW.
- No utilice nunca aceite para motores de cuatro tiempos.
- Un aceite de calidad deficiente o una mezcla de aceite/combustible demasiado rica puede perjudicar el funcionamiento del catalizador y reducir su vida útil.
- Mezcla
1:50 (2%) con aceite para motores de dos tiempos HUSQVARNA.
1:33 (3%) con otros aceites para motores de dos tiempos refrigerados por aire y clasificados para JASO FB/ISO EGB.

MANIPULACION DEL COMBUSTIBLE

Gasolina, litros	Aceite para motores de dos tiempos, litros	
	2% (1:50)	3% (1:33)
5	0,10	0,15
10	0,20	0,30
15	0,30	0,45
20	0,40	0,60

Mezcla

- Siempre haga la mezcla de gasolina y aceite en un recipiente limpio, homologado para gasolina.
- Primero, ponga la mitad de la gasolina que se va a mezclar. Luego, añada todo el aceite y agite la mezcla. A continuación, añada el resto de la gasolina.
- Agite bien la mezcla de combustible antes de ponerla en el depósito de combustible de la máquina.



- No mezcle más combustible que el necesario para utilizar un mes como máximo.
- Si no se ha utilizado la máquina por un tiempo prolongado, vacíe el depósito de combustible y límpielo.



¡ATENCIÓN! El silenciador del catalizador se calienta mucho, tanto durante el funcionamiento como después de la parada. Incluso funcionando éste en ralentí. Tenga presente el peligro de incendio, especialmente al manejar sustancias y/o gases inflamables.

Repostaje



¡ATENCIÓN! Las siguientes medidas preventivas reducen el riesgo de incendio:

No fume ni ponga objetos calientes cerca del combustible.

No haga nunca el repostaje con el motor en marcha.

Apague el motor y deje que se enfríe unos minutos antes de repostar.

Para repostar, abra despacio la tapa del depósito de combustible para evacuar lentamente la eventual sobrepresión.

Después de repostar, apriete bien la tapa del depósito de combustible.

Antes de arrancar, aparte siempre la máquina del lugar y de la fuente de repostaje.

- Utilice un recipiente de combustible con protección antirebose.
- Limpie alrededor de la tapa del depósito. Los residuos en el depósito ocasionan problemas de funcionamiento.
- Asegúrese de que el combustible esté bien mezclado sacudiendo el recipiente antes de llenar el depósito.

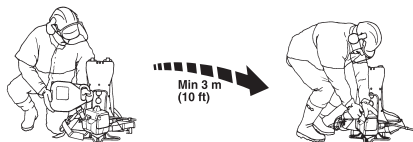

ARRANQUE Y PARADA

Control antes de arrancar



- Nunca utilice la máquina sin la protección o con una protección defectuosa.
- Todas las cubiertas deben estar correctamente montadas y en buenas condiciones antes de arrancar la máquina.
- Controle que la hoja no tenga grietas en la base de los dientes ni en el orificio central. El motivo más común de la aparición de grietas es que durante el limado se han formado esquinas agudas en la base de los dientes, o la hoja se utilizó con dientes desafilados. Cambie la hoja si descubre grietas.

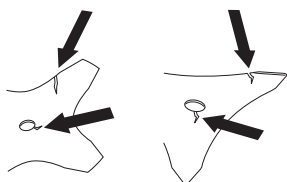

- Controle que la brida de apoyo no tenga grietas debido a fatiga del material o por estar demasiado apretada. Cambie la brida de apoyo si encuentra grietas.

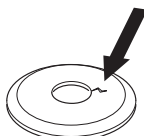

- Controle que la contratuerca no haya perdido la fuerza de bloqueo. El bloqueo de la tuerca debe tener un par de por lo menos 1,5 Nm. El par de apriete de la contratuerca debe ser de 35-50 Nm.



- Controle que la protección de la hoja no esté dañada ni presente grietas. Cambie la protección de la hoja si ha recibido golpes o está agrietada.

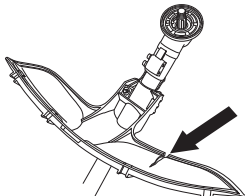

- Controle que el cabezal de corte y la protección de la recortadora no estén dañados ni presenten grietas.

Cambie el cabezal o la protección de la recortadora si han recibido golpes o están agrietados.

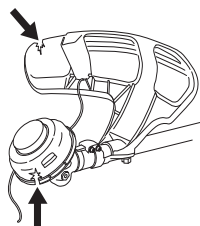

Arranque y parada



¡ATENCIÓN! Antes de arrancar la máquina debe montarse la cubierta del embrague completa con el tubo, de lo contrario el embrague puede zafar y provocar daños personales.

Antes de arrancar, aparte siempre la máquina del lugar y de la fuente de repostaje. Coloque la máquina sobre una base firme. Controle que el equipo de corte no pueda atascarse en algún objeto.

Asegúrese de que no haya personas desautorizadas en la zona de trabajo, de lo contrario se corre el riesgo de ocasionar graves daños personales. La distancia de seguridad es de 15 metros.

Arranque



Encendido: Coloque el mando de detención en posición de arranque.

Bomba de combustible: Presione varias veces la burbuja de goma de la bomba de combustible hasta que

ARRANQUE Y PARADA

comience a llenarse de combustible. No es necesario llenarla totalmente.

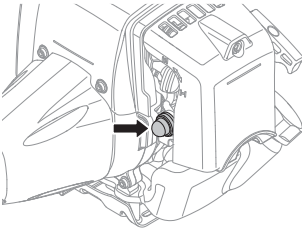

Estrangulador: Ponga el estrangulador en la posición de estrangulamiento.

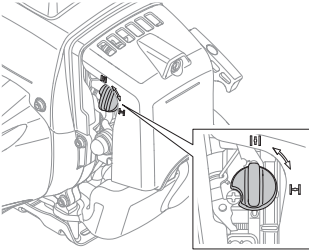

¡ATENCIÓN! Cuando el motor es arrancado con el estrangulador en la posición activada o de aceleración de arranque, el equipo de corte comienza a girar inmediatamente.

Presione el cuerpo de la máquina contra el suelo con la mano izquierda (ATENCIÓN: ¡No con el pie!). Agarre la empuñadura de arranque y tire despacio de la cuerda con la mano derecha, hasta sentir una resistencia (los dientes de arranque engranan), y después tire rápido y con fuerza. **Nunca enrosque el cordón de arranque alrededor de la mano.**

Al encender el motor, reponga inmediatamente el estrangulador a su posición inicial y repita el intento hasta que el motor arranque. Cuando el motor arranca, acelere rápidamente al máximo y la aceleración de arranque se desconecta automáticamente.

¡NOTA! No extraiga el cordón de arranque al máximo, y no suelte la empuñadura de arranque si ha extraído todo el cordón. Ello puede ocasionar averías en la máquina.

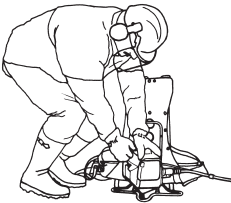

¡NOTA! No poner ninguna parte del cuerpo en la superficie marcada. El contacto puede causar quemaduras en la piel o sacudidas eléctricas si el excitador de ignición es defectuoso. Utilice siempre guantes protectores. No emplee nunca una máquina con un excitador de ignición defectuoso.

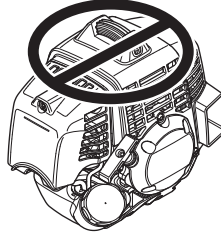

Parada



Para parar el motor, desconecte el encendido.

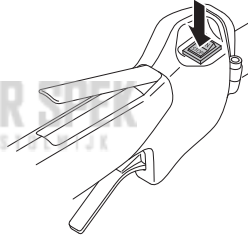

TÉCNICA DE TRABAJO

Instrucciones generales de trabajo

¡IMPORTANTE!

Esta sección trata reglas de seguridad fundamentales para el trabajo con la desbrozadora y la recortadora.

Cuando se vea en una situación insegura para continuar el trabajo, debe consultar a un experto. Póngase en contacto con su distribuidor o taller de servicio.

Evite todo uso para el cual no se sienta suficientemente calificado.

Antes del uso, Ud. debe haber entendido la diferencia entre desbroce forestal, desbroce de hierba y recorte de hierba.

Reglas básicas de seguridad



- 1 Observe el entorno para:
 - Comprobar que no hayan personas, animales, etc., que puedan influir en su control de la máquina.
 - Para evitar que personas, animales, etc. entren en contacto con el equipo de corte u objetos lanzados por el equipo de corte.
 - ¡NOTA! No use nunca una máquina si no tiene posibilidad de pedir auxilio si se produce un accidente.
- 2 Inspeccione la zona de trabajo. Quite todos los materiales sueltos como piedras, cristales rotos, clavos, alambres, cordones, etcétera, que puedan ser lanzados o enredarse en el equipo de corte.
- 3 No trabaje en condiciones atmosféricas desfavorables como niebla, lluvia intensa, tempestad, frío intenso, etc. El trabajo con mal tiempo es fatigoso y puede crear circunstancias peligrosas, como terreno resbaladizo, cambio imprevisto de la dirección de derribo de los árboles, etc.
- 4 Compruebe que pueda caminar y mantenerse de pie con seguridad. Vea si hay eventuales impedimentos para desplazamientos imprevistos (raíces, piedras, ramas, fosos, zanjas, etc.). Proceda con sumo cuidado al trabajar en terreno inclinado.



- 5 Durante el manejo, porte siempre esta sopladora de tipo mochila en su arnés de hombro.
- 6 Manténgase bien parado y con buen equilibrio.
- 7 Utilice siempre ambas manos para sujetar la máquina.
- 8 Mantenga el equipo de corte por debajo de la cintura.
- 9 Si va a trasladarse de un lugar a otro, apague primero el motor. Para desplazamientos largos y al transportar el equipo, se debe utilizar la protección para transportes.
- 10 No apoye nunca la máquina con el motor en marcha sin tenerla bajo control.



¡ATENCIÓN! Ni el usuario de la máquina ni ninguna otra persona debe intentar quitar la vegetación cortada cuando el motor o el equipo de corte aún están girando, dado que esto comporta riesgo de daños graves.

Pare el motor y el equipo de corte antes de quitar la vegetación que se ha enrollado en el eje de la hoja, porque de lo contrario pueden producirse daños. Durante el uso y poco después, el engranaje angulado puede estar caliente. El contacto con el mismo puede ocasionar quemaduras.



¡ATENCIÓN! Advertencia de objetos lanzados. Utilice siempre gafas protectoras homologadas. No se incline nunca sobre la protección del equipo de corte. Hay riesgo de lanzamiento de piedras, suciedad, etcétera, contra los ojos; causando ceguera o daños graves.

Mantenga alejados a los terceros. Los niños, animales, curiosos y ayudantes deben mantenerse fuera de la zona de seguridad de 15 metros. Pare la máquina inmediatamente si alguien se acerca. Nunca gire con la máquina si no ha verificado antes que la zona de seguridad atrás de Ud. está vacía.

Técnica básica de trabajo

Después de cada momento de trabajo reduzca siempre la velocidad del motor a ralentí. Un tiempo demasiado largo a máxima velocidad sin que el motor esté cargado puede averiar seriamente el motor.



¡ATENCIÓN! A veces, se atascan ramas o hierba entre la protección y el equipo de corte. Antes de retirarlos, pare siempre el motor.

TÉCNICA DE TRABAJO



¡ATENCIÓN! Las máquinas equipadas con hojas de sierra u hojas para hierba pueden ser despedidas violentamente hacia un lado cuando la hoja entra en contacto con un objeto fijo. A este efecto se le llama lanzada de hoja. Una lanzada de hoja puede tener violencia suficiente para lanzar la máquina y/o el operador en cualquier dirección, e incluso hacer perder el control de la máquina. La lanzada de hoja se puede producir inadvertidamente si la máquina toca un obstáculo, se para o se adhiere. La lanzada de hoja tiene mayores probabilidades de ocurrir en zonas en las que es difícil ver el material que se corta.

Evite cortar con la zona de corte de la hoja entre las 12 y 3 horas. Por la velocidad de rotación de la hoja pueden producirse reculadas justo en esta zona de corte de la hoja, cuando se intenta cortar troncos más gruesos.

Desbroce de hierba con hoja para hierba



- Las hojas y cuchillas para hierba no deben utilizarse para tallos leñosos.
- Para todo tipo de hierba alta o gruesa se utiliza la hoja para hierba.
- Corte la hierba con un movimiento de barrido pendular, donde el movimiento de derecha a izquierda es el de desbroce y el de izquierda a derecha, el de retorno. Haga trabajar a la parte izquierda de la hoja (entre las 8 y las 12).

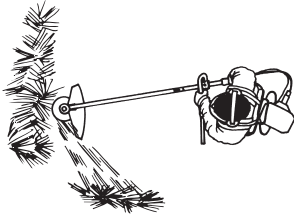

- Si al desbrozar la hierba la hoja es inclinada un poco hacia la izquierda, la hierba se acumula en una hilera que es más fácil de juntar posteriormente, por ejemplo al rastrillar.
- Trate de trabajar siguiendo un ritmo. Párese firmemente con las piernas abiertas. Avance después del movimiento de retorno y párese nuevamente con firmeza.
- Deje que la cazoleta de apoyo toque ligeramente el suelo. Su función es evitar que la hoja corte en el suelo.

- Para evitar que la vegetación cortada se enrolle en la hoja, haga lo siguiente:

1 Trabaje siempre a máxima velocidad.

2 Durante el movimiento de retorno, evite barrer sobre lo que acaba de cortar.

- Pare el motor, afloje el arnés y apoye la máquina en el suelo antes de recoger la vegetación cortada.

Recorte de hierba con el cabezal de corte



Recorte

- Mantenga el cabezal de corte justo por encima del suelo, en posición inclinada. Es la punta del hilo la que realiza el trabajo. Deje que el hilo trabaje con su propio ritmo. Nunca lo presione contra la vegetación que quiere segar.

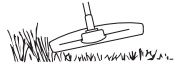

- El hilo corta con facilidad la hierba y las malas hierbas que hay contra paredes, cercas, árboles y arriates, pero también puede dañar la corteza delicada de árboles y arbustos, y postes de cercas.
- Disminuya el peligro de daños en las plantas acortando el hilo a 10-12 cm y disminuyendo las revoluciones del motor.

Raspado

- La técnica de raspado corta toda la vegetación no deseada. Mantenga el cabezal de corte justo por encima del suelo, en posición inclinada. Deje que la punta del hilo golpee el suelo alrededor de árboles, columnas, estatuas, etc. ATENCIÓN: Esta técnica aumenta el desgaste del hilo.



- El hilo se desgasta más rápido y se debe alimentar más seguido al trabajar contra piedras, ladrillos, hormigón, cercas de metal, etc. que al estar en contacto con árboles y cercas de madera.
- Al recortar y raspar debe utilizar una velocidad un poco menor que la aceleración máxima para que el hilo dure más y el cabezal de corte se desgaste menos.

Corte

- La recortadora es ideal para cortar en lugares que son difícilmente accesibles para un cortacésped común. Al cortar, mantenga el hilo paralelo al suelo.

TÉCNICA DE TRABAJO

Evite presionar el cabezal de corte contra el suelo para no dañar el césped ni el equipo.

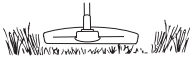

- Durante el corte normal evite que el cabezal de corte esté en contacto continuo con el suelo. Un contacto continuo de este tipo puede causar daños y desgaste en el cabezal de corte.

Barrido

- El efecto ventilador del hilo giratorio puede utilizarse para una limpieza rápida y sencilla. Mantenga el hilo paralelo y por encima de la superficie a barrer y mueva la máquina de un lado a otro.

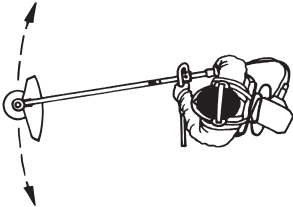

- Al cortar y barrer debe utilizar la aceleración máxima para obtener un buen resultado.

KEES VAN DER SPEK
TUINMACHINES ★ STOLWIJK

Carburador

Regulación de la marcha en ralentí (T)

Controle que el filtro de aire esté limpio. Cuando la marcha en ralentí está correctamente regulada, el equipo de corte no debe rotar. Si es necesario ajustar, cierre (sentido horario) el tornillo T con el motor en marcha hasta que el equipo de corte comience a girar. Abra (sentido antihorario) el tornillo hasta que el equipo de corte se detenga. Se ha logrado el régimen correcto de marcha en ralentí cuando la marcha del motor sea uniforme en todas las posiciones, con un amplio margen hasta el régimen en que el equipo de corte comienza a girar.

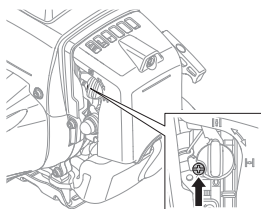

¡ATENCIÓN! Si no puede regular el régimen en ralentí para que el equipo de corte deje de girar, consulte a su distribuidor/taller de servicio. No utilice la máquina hasta que no esté correctamente regulada o reparada.

Filtro de aire



El filtro de aire debe limpiarse regularmente de polvo y suciedad para evitar:

- Fallos del carburador
- Problemas de arranque
- Reducción de la potencia
- Desgaste innecesario de las piezas del motor.
- Un consumo de combustible excesivo.

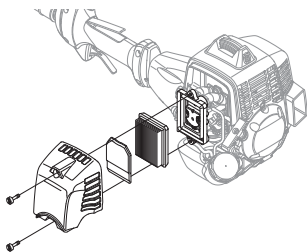

Limpie el filtro cada 25 horas de funcionamiento o más seguido si trabaja en un entorno muy polvoriento.

Limpieza del filtro de aire

Desmonte la cubierta del filtro de aire y retire el filtro. Lávelo en agua jabonosa caliente. Controle que el filtro esté seco antes de volver a montarlo.

Un filtro utilizado durante mucho tiempo no puede limpiarse del todo. Por tanto, hay que cambiarlo a intervalos regulares. **Un filtro de aire averiado debe cambiarse.**

Filtro de combustible

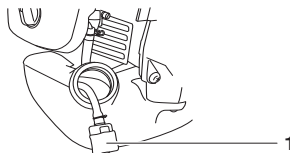

1 Filtro de combustible

Quando el motor se quede sin suministro de combustible, compruebe la tapa y el filtro del combustible para verificar si están obstruidos.

Engranaje angulado



El engranaje angulado se entrega de fábrica con la cantidad adecuada de grasa. No obstante, antes de empezar a utilizar la máquina, verifique que el engranaje esté lleno con grasa hasta las 3/4 partes. Use grasa especial de HUSQVARNA.

Generalmente, el lubricante en el cuerpo del engranaje no requiere cambiarse excepto cuando se realizan reparaciones.

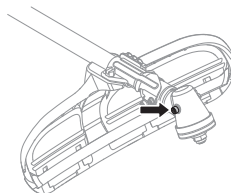

Bujía



Los factores siguientes afectan al estado de la bujía:

- Carburador mal regulado.
- Mezcla de aceite inadecuada en el combustible (demasiado aceite o aceite inadecuado).
- Filtro de aire sucio.

MANTENIMIENTO

Estos factores producen revestimientos en los electrodos de la bujía que pueden ocasionar perturbaciones del funcionamiento y dificultades de arranque.

Si la potencia de la máquina es demasiado baja, si es difícil arrancar la máquina o si el ralentí es irregular: revise primero la bujía antes de tomar otras medidas. Si la bujía está muy sucia, límpiela y compruebe que la separación de los electrodos sea de 0,6-0,7 mm. La bujía debe cambiarse aproximadamente después de un mes de funcionamiento o más a menudo si es necesario.

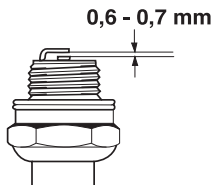

¡NOTA! ¡Utilice siempre el tipo de bujía recomendado! Una bujía incorrecta puede arruinar el pistón y el cilindro. Asegúrese de que la bujía tenga supresión de perturbaciones radioeléctricas.

Eje propulsor



El eje motor flexible está lubricado con grasa para ejes motores de Husqvarna. El eje debe lubricarse como mínimo cada 6 meses.

- Levante el botón de bloqueo que sostiene la carcasa del eje propulsor en la cubierta del embrague.

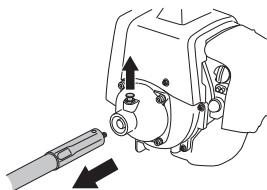

- Retire la carcasa del eje propulsor de la cubierta del embrague.
- Retire el eje propulsor de la carcasa sacudiéndolo o extrayéndolo con unas tenazas.

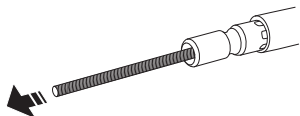

- Aplique la grasa del tubo a lo largo de todo el eje. Extiéndala con algodón o con un trapo.

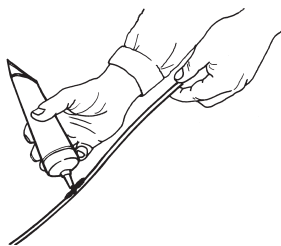

- Vuelva a colocar el eje propulsor en la carcasa. Cerciñese de que el eje se enganche girándolo al tiempo que se lo empuja hacia abajo.

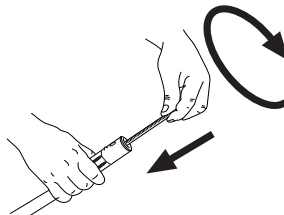

- Cuando el eje está correctamente montado en la carcasa, la punta del eje debe quedar unos 10 mm fuera del borde de la carcasa.

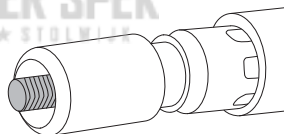

- Monte la carcasa del eje propulsor en la cubierta del embrague de manera que el orificio quede situado justamente debajo del botón de bloqueo de la cubierta del embrague.

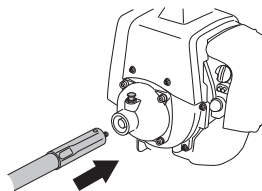

- Asegúrese de que el eje se acopla correctamente girándolo y empujándolo simultáneamente.

MANTENIMIENTO

Programa de mantenimiento

A continuación incluimos una lista con los puntos de mantenimiento a efectuar en la máquina. La mayoría de los puntos se describen en el capítulo "Mantenimiento". El usuario sólo puede efectuar los trabajos de mantenimiento y servicio descritos en este manual. Los trabajos de mayor envergadura debe efectuarlos un taller de servicio oficial.

Mantenimiento	Mantenimiento diario	Mantenimiento semanal	Mantenimiento mensual
Limpe la parte exterior de la máquina.	X		
Controle que el arnés no esté dañado.	X		
Controle que los casquillos aislantes de las vibraciones no estén dañados.	X		
Compruebe que la empuñadura y el manillar estén intactos y bien fijos.	X		
Controle que el mando de detención funcione.	X		
Controle que el equipo de corte no gire en ralentí.	X		
Limpe el filtro de aire. Cámbielo si es necesario.	X		
Controle que la protección no esté dañada y que no tenga grietas. Cambie la protección si ha estado expuesta a golpes o si tiene grietas.	X		
Controle que la hoja esté correctamente centrada, tenga buen filo y no presente grietas. Una hoja descentrada provoca vibraciones que pueden dañar la máquina.	X		
Controle que el cabezal de corte no esté dañado ni tenga grietas. Cambie el cabezal de corte si es necesario.	X		
Compruebe que la tuerca de seguridad del equipo de corte está adecuadamente apretada.	X		
Controle que la protección para transportes de la hoja esté en buen estado y que se pueda fijar correctamente.	X		
Compruebe que los tornillos y las tuercas estén apretados.	X		
Controle que no haya fugas de combustible del motor, del depósito o de los conductos de combustible.	X		
Controle el mecanismo de arranque y la cuerda del mismo.		X	
Compruebe que estén intactos los aisladores de vibraciones.		X	
Limpe la bujía por fuera. Quítela y controle la distancia entre los electrodos. Ajuste la distancia a 0,6-0,7 mm o cambie la bujía. Controle que la bujía tenga supresión de perturbaciones radioeléctricas.		X	
Limpe el sistema de refrigeración de la máquina.		X	
Limpe el exterior del carburador y la zona alrededor del mismo.		X	
Controle que el engranaje angulado tenga grasa hasta las 3/4 partes. Si es necesario llene con grasa especial.		X	
Limpe el silenciador.			X
Compruebe que el filtro de combustible no está sucio y que la manguera de combustible no tiene grietas ni otros defectos. Cambie el componente que sea necesario.			X
Revise todos los cables y conexiones.			X
Compruebe si están desgastados el embrague, los muelles de embrague y el tambor embrague. Cambie los componentes que sea necesario en un taller de servicio oficial.			X
Cambie la bujía. Controle que la bujía tenga supresión de perturbaciones radioeléctricas.			X
Lubrique el eje motor con grasa para ejes motores de Husqvarna.	Esta operación se hace cada seis meses.		

DATOS TECNICOS

Datos técnicos

	553RBX
Motor	
Cilindrada, cm ³	50,6
Diámetro del cilindro, mm	45,5
Carrera, mm	31,1
Régimen de ralentí, r.p.m.	2800
Régimen máximo de embalamiento recomendado, r.p.m.	13000
Velocidad en el eje de salida, rpm	9285
Potencia máxima del motor según ISO 8893, kW/ r.p.m.	2,3/9500
Silenciador con catalizador	No
Sistema de encendido	
Bujía	NGK CMR7H
Distancia de electrodos, mm	0,6-0,7
Sistema de combustible y lubricación	
Capacidad del depósito de gasolina, litros	0,8
Peso	
Peso sin combustible, equipo de corte y protección, kg	12,1
Emisiones de ruido	
(ver la nota 1)	
Nivel de potencia acústica medido dB(A)	117
Nivel de potencia acústica garantizado L _{WA} dB(A)	118
Niveles acústicos	
(vea la nota 2)	
Nivel de presión sonora equivalente en la oreja del usuario, medido según EN ISO 11806 e ISO 22868, dB(A):	
Equipada con cabezal de corte (original).	97
Equipada con hoja para hierba (original).	97
Niveles de vibraciones	
(vea la nota 3)	
Niveles de vibración equivalentes (a _{hv, eq}) en las empuñaduras, medidos según la norma EN ISO 11806 e ISO 22867, m/s ² .	
Equipada con cabezal de corte (original), izquierda / derecha.	2,7/3,3
Equipada con hoja para hierba (original), izquierda / derecha.	2,7/3,8

Nota 1: Emisiones sonoras en el entorno medidas como potencia acústica (L_{WA}) según la directiva CE 2000/14/CE. El nivel referido de potencia sonora de la máquina se ha medido con el equipo de corte original que produce el nivel más elevado. La diferencia entre la potencia sonora garantizada y medida es que la potencia sonora garantizada también incluye la dispersión en el resultado de la medición y las variaciones entre diferentes máquinas del mismo modelo, según la Directiva 2000/14/CE.

Nota 2: Los datos referidos del nivel de presión sonora equivalente de la máquina tienen una dispersión estadística habitual (desviación típica) de 1 dB (A).

Nota 3: Los datos referidos del nivel de vibración equivalente poseen una dispersión estadística habitual (desviación típica) de 1 m/s².

DATOS TECNICOS

Accesorios homologados	Tipo	Protección para el equipo de corte, Art. nº.
Hoja para hierba/cuchilla para hierba	Multi 300-3 (Ø 300 3 dientes)	537 33 16-03
	Multi 275-4 (Ø 275 4 dientes)	537 33 16-03
Cabezal de corte	T45x (hilo Ø 2,7-3,3 mm)	537 33 16-03
	T55x (hilo Ø 2,7-3,3 mm)	537 33 16-03
Cazoleta de apoyo	Fija	-

Declaración CE de conformidad (Rige sólo para Europa)

Nosotros, **Husqvarna AB**, SE-561 82 Huskvarna, Suecia, tel. +46-36-146500, declaramos que las desbrozadoras **Husqvarna 553RBX** a partir del número de serie del año 2012 en adelante (el año se indica claramente en la placa de identificación, seguido del número de serie), cumplen con las siguientes disposiciones de la DIRECTIVA DEL CONSEJO:

- **2006/42/CE** «relativa a máquinas» del 17 de mayo de 2006.
- **2004/108/CEE**, "referente a compatibilidad electromagnética", del 15 de diciembre de 2004.
- **2000/14/CE**, "sobre emisiones sonoras en el entorno" del 8 de mayo de 2000. Declaración de conformidad efectuada según el anexo V. Para más información sobre las emisiones sonoras, consulte el capítulo Datos técnicos.

Se han aplicado las siguientes normas: **EN ISO 12100:2010, CISPR 12:2007, ISO 14865:1998.**

SMP Svensk Maskinprovning AB, Fyrisborgsgatan 3, SE-754 50 Uppsala, Suecia, ha efectuado un ensayo de tipo voluntario para Husqvarna AB.

El certificado tiene el número: **SEC/12/2344**

Huskvarna, 8 de febrero de 2012

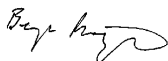

KEES VAN DER SPEK
TUINMACHINES * STOLWIJK

Bengt Frögelius, Jefe de Desarrollo (Presentante autorizado de Husqvarna AB y responsable de la documentación técnica.)

SEMBOLLERİN AÇIKLANMASI

Semboller

UYARI! Bir taş kesme testeresi, çalı budayıcısı veya kesicinin dikkatsiz veya yanlış kullanılması, bu araçları kullanan kişilerin veya diğer insanların ölümüne veya tehlikeli bir şekilde yaralanmalarına yol açabilir. Burada size sunulan, kullanma talimatını okumanız ve içeriğini anlamınız çok önem taşımaktadır.

Makineyi kullanmadan önce kullanım kılavuzunu iyice okuyarak içeriğini kavrayınız.

Her zaman kullanılması gereken malzemeler:

- Testere kullanılırken koruma başlığı kullanmak risklidir, başlığın testerenin üzerine düşmesi tehlikesi vardır
- Onanmış koruyucu kulaklık
- Gözlerin korunması onaylanmıştır

Maksimum hareket eden omuz üzerindeki devir sayısı, rpm.

Bu ürün geçerli CE direktiflerine uygundur.

Testereyle çalışmaya başlarken sakın olmaya özen gösteriniz.

Makineyi kullanan kişi, çalışma esnasında kendisine insanların veya hayvanların 15 metreden daha fazla yaklaşmasına izin vermemelidir.

Testere bıçağı veya çim bıçağı takılı makineler, bıçak sabit bir nesneye temas ettiğinde şiddetle yan tarafa savrulabilir. Buna bıçak savrulması denir. Bıçak, kol veya bacağı kopmasına neden olabilir. İnsanların ve hayvanların makineden daima en az 15 metre uzakta kalmalarını sağlayın.

Söğütlerden oluşan sınırlar, elle tutularak yerleştirilmelidir.

Ateşleme; jikle: Jikle ayarını jikle durumuna getiriniz. Bu durumda stop kontağı otomatik olarak start pozisyonuna gelir.

Yakıt pompası.



Her zaman onanmış koruyucu eldivenler kullanılmalıdır.



Kaygan olmayan ve sağlam çizmeler kullanınız.



Kesme teçhizatı bükülgen özelliği olan metalden oluşmamalıdır; örn: ayar başlığı ve ayar halatı bu özellikte olmalıdır.



Çevreye verdiği gürültü emisyonları Avrupa Birliği'nin direktiflerine uygundur. Makinenin emisyonları Teknik bilgiler bölümünde ve etikette belirtilmiştir.



Vücudunuzun tüm bölümlerini sıcak yüzeylerden uzakta tutun.



Makina üzerindeki diğer semboller/etiketler kimi pazarlarda onay almak için gerekli özel koşullarla ilgilidir.

Kontrol ve/veya bakım, motor durdurulduktan ve STOP durumuna getirildikten sonra yapılmalıdır.



Her zaman onanmış koruyucu eldivenler kullanılmalıdır.



Düzenli aralıklarla temizlik gerekmektedir.



Gözle bakarak kontrol.



İÇİNDEKİLER

İçindekiler

SEMBOLLERİN AÇIKLANMASI

Semboller 156

İÇİNDEKİLER

İçindekiler 157

Başlamadan önce aşağıdaki konulara dikkat ediniz: 157

GİRİŞ

Değerli Müşterimiz, 158

NE NEDİR?

Arazi testeresi nedir? 159

GENEL GÜVENLİK AÇIKLAMALARI

Önemli 160

Kişisel koruyucu araçlar 160

Makinenin güvenlik donanımı 161

Kesici gereçler 163

MONTAJ

Esnek hareket milini takma 165

Gaz kablosunu ve durdurma düğmesi kablolarını takma 165

J-tutamağı takma 165

Keskin alet ağızlarının ve başlıklarının montaj işlemi .. 166

Nakliye koruyucusunu takma 167

Temizlik testeresine kayış uyumu 167

YAKIT KULLANIMI

Yakıt güvenliği 169

Çalıştırıcı 169

Yakıt ikmali 170

ÇALIŞTIRMA VE DURDURMA

Başlamadan önce kontrol yapınız. 171

Çalıştırma ve durdurma 171

ÇALIŞMA TEKNİKLERİ

Genel çalışma açıklamaları 173

BAKIM

Karbüratör 175

Hava filtresi 175

Yakıt filtresi 175

Debriyajlar 175

Buji 175

Tahrik mili 176

Bakım şeması 177

TEKNİK BİLGİLER

Teknik bilgiler 178

Uygunluk konusunda AB deklarasyonu 179

Başlamadan önce aşağıdaki konulara dikkat ediniz:

Kullanım kılavuzunu dikkatle okuyunuz.



UYARI! Kesme işlemi yaparken uzun süre gürültüye maruz kalma, duyma bozukluğuna yol açabilir. Bu nedenle daima onaylanmış bulunan, gürültüye karşı koruma cihazı kullanınız.



UYARI! İmalatçının izni olmaksızın makinenin orijinal yapısı hiçbir biçimde değiştirilemez. Her zaman orijinal yedek parça kullanılmalıdır. Yetkili olmayan kişiler tarafından yapılan değişiklikler ve/veya orijinal olmayan parçalar, kullanıcının yaralanmasına ya da ölümüne neden olabilir.



UYARI! Bir taş kesme testeresi, çalı budayıcısı veya kesicinin dikkatsiz veya yanlış kullanılması, bu araçları kullanan kişilerin veya diğer insanların ölümüne veya tehlikeli bir şekilde yaralanmalarına yol açabilir. Burada size sunulan, kullanma talimatını okumanız ve içeriğini anlamınız çok önem taşımaktadır.

KEES VAN DER SPEK
NEDERLANDS
STOLWIJK

GİRİŞ

Değerli Müşterimiz,

Bir Husqvarna ürünü aldığınız için sizi kutlarız. Husqvarna, İsveç Kralı XI. Karl'ın ağızdan dolma tüfek yapımı için Husqvarna nehri kıyısında bir fabrika kurulmasını emrettiği 1689 yılından bu yana olan birikimin ve geleneğin ürünüdür. Su gücüyle çalışan bir fabrika için Husqvarna nehrinin sularından yararlanmak amacıyla yapılan yer seçimi de son derece mantıklıydı. 300 yılı aşkın ömrü süresince Husqvarna fabrikası, odun sobasından modern mutfak malzemelerine, dikiş makinelerine, bisikletlere, motosikletlere kadar birçok farklı ürün imal etmiştir. İlk motorlu çim biçme makineleri 1956 yılında üretilmeye başlandı ve bunun ardından 1959'da zincirli testerele geldi; Husqvarna'nın bugün uzmanlaştığı alan da bu oldu.

Günümüzde artık Husqvarna, en büyük önceliği kalite olan, dünyanın en önde gelen orman ve bahçe ekipmanı üreticisidir. Misyonumuz, ormancılık ve bahçeciliğin yanı sıra inşaat sektörü için de motorla çalışan ekipmanlar geliştirmek, üretmek ve pazarlamaktır. Husqvarna'nın amacı, ergonomik, kullanılabilirlik, güvenlik ve çevre koruması konularında da her zaman en önde olmaktır. İşte bu nedenle, çalıştığımız bu alanlarda sizlere farklı özellikleri olan ürünler geliştirmiş bulunmaktayız.

Ürünlerimizi kalite ve performans açısından büyük bir memnuniyetle uzun yıllar kullanacağınıza inancımız tamdır. Ürünlerimizden herhangi birini satın almanız, gerektiğinde profesyonel onarım ve servis hizmetlerine ulaşmanızı sağlar. Makinenizi satın aldığımız yer yetkili bayilerimizden biri değilse, size en yakın servis istasyonunun adresini isteyin.

Dileğimiz, ürünümüzden memnun kalmanız ve uzun yıllar kullanmanızdır. Bu kullanım kılavuzunu değerli bir belge olarak koruyun. İçinde önerilenleri (kullanım, servis, bakım, vs.) yerine getirerek makinenizin ömrünü uzatabilir ve elden düşme satış değerini artırabilirsiniz. Bir gün makinenizi satarsanız, yeni sahibine kullanım kılavuzunu da vermeyi ihmal etmeyin.

Husqvarna ürünlerini kullandığımız için teşekkür ederiz.

Husqvarna AB ürünlerini sürekli olarak geliştirmeye çalışmaktadır, bu yüzden ürünlerin biçim ve görünüşleri konusunda önceden haber vermeksizin değişiklik yapma hakkımız saklıdır.

KEES VAN DER SPEK
TUINMACHINES ★ STOLWIJK

NE NEDİR?

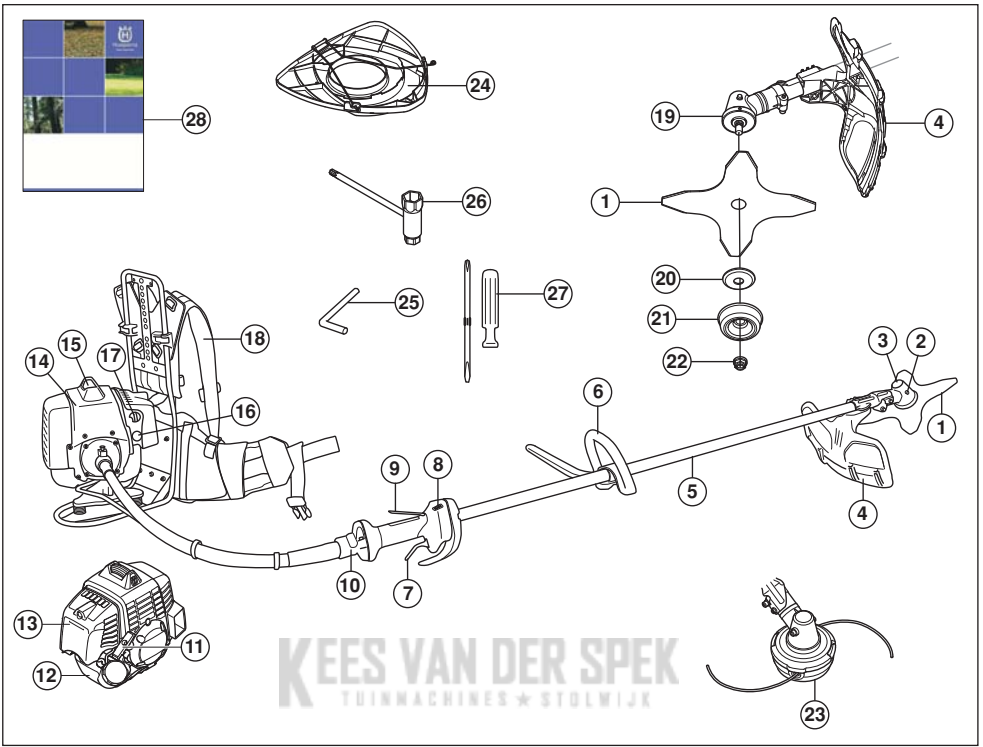

Arazi testeresi nedir?

- 1 Keskin aletlerde ağız kısmı
- 2 Cihaza yağ doldurma, debriyajlar
- 3 Debriyajlar
- 4 Kesme cihazlarının korunması
- 5 Teçhizat borusu
- 6 Tutamak
- 7 Gaz ayarı
- 8 Stop düğmesi
- 9 Kelebek kilidi
- 10 Bağlantı borusu
- 11 Çalıştırma tutacağı
- 12 Yakıt deposu
- 13 Hava filtresi
- 14 Silindir kapağı
- 15 Buji kapağı ve buji
- 16 Yakıt pompası.
- 17 Şok ayar kolu
- 18 Kayış
- 19 Yardımcı araçlar
- 20 Yırılmaya karşı destek cihaz
- 21 Destek fincanı
- 22 Kilit cıvata somunları
- 23 Kesme başlığı
- 24 Taşıma ile ilgili korumalar
- 25 Kilit çubuğu
- 26 Kesici aletlerde kullanılan cıvata somun anahtar
- 27 Tornavida
- 28 Kullanım kılavuzu

GENEL GÜVENLİK AÇIKLAMALARI

Önemli

ÖNEMLİ!

Bu makine sadece çimleri kırmak ve çimlerde alan açmak için tasarlanmıştır.

Kesme cihazları için motor parçası olarak kullanabileceğiniz araç-gereçlerin kaynaklarını size tavsiyede bulunduğumuz Teknik veri bölümünde bulabilirsiniz.

Yorgun ya da içkili iken ya da görüş, karar verme ve bedensel denetim yeteneklerinizi etkileyebilecek olan bir ilaç almışsanız makineyi asla kullanmayınız.

Kişisel koruyucu araçlar kullanınız. Kişisel koruyucu araçlar bölümüne bakınız.

Artık orijinal imalatına benzerliği kalmayacak biçimde yapısal değişikliğe uğratılmış bir makineyi asla kullanmayınız.

Hatalı bir makineyi asla kullanmayınız. Elinizdeki broşürde bulunan bakım, denetim ve servisle ilgili açıklamaları izleyiniz. Kimi bakım ve servis önlemleri, deneyimli ve kalifiye ustalar tarafından yapılmalıdır. Bakım bölümüne bakınız.

Çalıştırmadan önce tüm kapaklar, siperler ve tutamaklar takılmalıdır. Elektrik çarpması riskini engellemek için buji kapağının ve ateşleme kablosunun hasarsız olduğundan emin olun.

Makineyi kullanan kişi, çalışma sırasında, makineye insan veya hayvanların 15 metreden daha fazla yaklaşmamasına dikkat etmelidir. Eğer bir çalışma bölgesinde bir çok kişi bir arada çalışıyorsa, güvenlik mesafesi çalışma bölgesinin iki katı uzaklığında olmalı veya en az 15 metre olmalıdır.



UYARI! Bu makine, çalışması sırasında bir elektromanyetik alan oluşturur. Bu alan, bazı koşullarda aktif veya pasif tıbbi implantlarda girişime neden edebilir. Ciddi veya ölümcül yaralanma riskini azaltmak için, tıbbi implantlar takılı kişilerin, bu makineyi çalıştırmadan önce doktorlarına ve tıbbi implant üreticisine danışmanlarını öneririz.



UYARI! Motorun kapalı veya havalandırması iyi olmayan yerlerde çalıştırılması havasızlıktan boğulmaya veya karbon monoksit zehirlenmesine yol açabilir.



UYARI! Hiçbir zaman çocukların makineyi kullanmalarına veya yakınında olmalarına izin vermeyin. Makede yaylı durdurma anahtarı olduğundan ve çalıştırma elçigine uygulanabilecek az bir güç ve hızlı çalıştırılabileceğinden, bazı koşullarda küçük çocuklar bile makinenin çalışması için gereken gücü bulabilirler. Bu da ciddi yaralanmalara yol açabilir. Bu nedenle makine yakın gözetiminiz altında olmadığı zaman buji kapağını çıkarın.

Kişisel koruyucu araçlar

ÖNEMLİ!

Bir taş kesme testeresi, çalı budayıcısı veya kesicinin dikkatsiz veya yanlış kullanılması, bu araçları kullanan kişilerin veya diğer insanların ölümüne veya tehlikeli bir şekilde yaralanmalarına yol açabilir. Burada size sunulan, kullanma talimatını okumanız ve içeriğini anlamınız çok önem taşımaktadır.

Makineyi her kullandığınızda, onaylanmış kişisel koruyucu araçlar kullanmalısınız. Kişisel koruyucu araçlar sakatlanma tehlikesini ortadan kaldırmazlar da, herhangi bir kazanın meydana gelmesi durumunda yaralanma derecesini azaltırlar. Uygun kişisel koruyucu araçlar seçmekte satıcınızın yardımını isteyiniz.



UYARI! Gürültüye karşı koruma cihazı kullanılırken, uyarı sinyallerine ve seslerine karşı daima dikkatli olunuz. Motor durdurulduktan hemen sonra, gürültüye karşı koruma cihazını çıkartınız.

MİĞFER

Testere kullanılırken koruma başlığı kullanmak risklidir, başlığın testerenin üzerine düşmesi tehlikesi vardır



GÜRÜLTÜYE KARŞI KORUMA CİHAZI

Gürültüye karşı koruma cihazı, yeterli bir susturucu etkisi sağlıyorsa kullanılmalıdır.



GÖZ KORUMA CİHAZI (GÖZLÜK)

Daima onaylanmış bulunan göz koruma cihazları kullanı lmalı dır. Miğferin ön parçası nda kullanı lan koruma gözlüğü de mutlaka onaylanmış olmalı dır. Koruma gözlüğünün onaylanması ş olması demek, ABD'nin ANSI Z 87.1. standartları na veya AB ülkelerinin EN 166 standartları için aranan şartlara uygun olması anlamı na gelir.

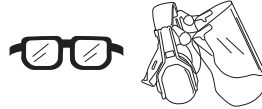

ELDİVENLER

Eldivenler ihtiyaç duyulduğu zaman kullanılabilir, Örn: kesme cihazlarının monte işlemlerinde mutlaka kullanılmalıdır.



GENEL GÜVENLİK AÇIKLAMALARI

ÇİZMELER

Kaygan olmayan ve sağlam çizmeler kullanınız.



ELBİSELER

Kesme işlemini yaparken yırtılmaya dayanıklı elbiseler kullanınız, çalılıklara ve dallara kolayca takılma riski taşıyan geniş elbiseler giymekten kaçınınız. Daima sağlam ve dayanıklı uzun paçalı pantolonları kullanınız. Kesme işlemini yaparken ziynet eşyası takmayınız, kısa pantolon veya sandalet giymeyiniz ve çıplak ayakla çalışmayınız. Saçlarınızın omuzlarınızda doğru sarkmamasına özen gösteriniz.

İLK SARGI

İlk yardım çantası her zaman kolay ulaşılabir yerde olmalıdır.



Makinenin güvenlik donanımı

Bu bölümde, makinenin güvenlik donanımı konusunda ayrıntıların neler olduğu, bunların hangi işlemlere sahip bulunduğu ve doğru çalışıp çalışmadığına emin olmak için kontrol ve bakımının nasıl gerçekleştirileceği açıklanmaktadır. Bu teçhizatın makinenin neresinde olduğunu görmek için Ne nedir? bölümüne bakınız.

Makine doğru bir şekilde kullanılmaz ve gerekli onarımlar ve bakımlar yetkili servis ve bilirkişiler tarafından yapılmazsa, o taktirde makinenin ömrünün uzunluğu kısalsabilir ve kaza riski artabilir. Eğer daha fazla bilgiye ihtiyaç duyuyorsanız, en yakın servis istasyonuna başvuruda bulununuz.

ÖNEMLİ! Makinenin her türlü servis ve onarımı özel eğitim gerektirmektedir. Bu, özellikle makinenin güvenlik donanımıyla ilgilidir. Eğer makineniz aşağıdaki listede yer alan denetimlerden herhangi birinde takılırsa, servis atelyenize başvurunuz. Ürünlerimizden herhangi birini satın aldığınızda, profesyonel tamir ve servis sunacağımızı garanti ederiz. Makineyi size satan satıcı servis satıcısı değilse, en yakın servis temsilcisinin adresini vermesini isteyiniz.



UYARI! Bozuk güvenlik gereçlerine sahip bir makineyi asla kullanmayınız. Bu bölümde belirtilen kontrolleri ve bakım önlemlerini uygulayınız. Makineniz bu denetimlerden herhangi birisinde takılırsa onarım için servis ajanınıza başvurunuz.

Kelebek kilidi

Kelebek kilidi, istenmeyen durumlarda gaz ayarının etkinleşmesini önlemek için yapılmıştır. Dügmeye (A) basınca (elinizi kulpa bastırınca) gaz ayarı (B) devreden çıkar. Elinizi

kaldırdığınızda ise hem gaz ayarı hem de gaz ayarlama düğmesi eski durumuna döner. Bu hareket iki tane bağımsız dönüş yayı tarafından kontrol edilir. Bu düzenleme sayesinde, elinizi kulptan kaldırdığınızda kelebek kontrolü otomatik olarak çalışmama durumunda kilitlenir.

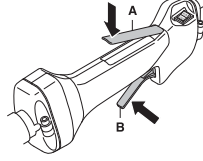

Gaz ayarlama düğmesi asıl konumunda iken gaz ayarının boşta olduğunu denetleyiniz.

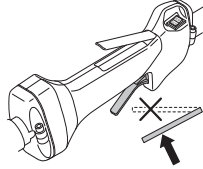

Kelebek kilidine basınız ve bıraktığınız zaman yeniden asıl konumuna geldiğini denetleyiniz.

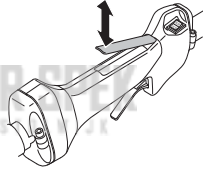

Gaz ayarının ve kelebek kilidinin rahat çalışmakta olduğunu ve dönüşüm makası sisteminin çalıştığını denetleyiniz.

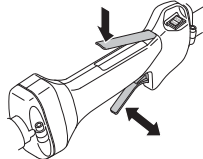

Başlangıç bölümündeki talimatlara bakınız. Makineyi çalıştırınız ve tam gaz veriniz. Makinedeki gaz ayar kolunu bırakınız ve cihazı durduğunu (hareket etmediğini) kontrol ediniz. Eğer makine, gaz ayar kolu boşta iken hareket ediyorsa, o taktirde karbüratörün boşta iken ayarı yapılacaktır. Başlığın altındaki bakım bölümündeki talimatlara bakınız.

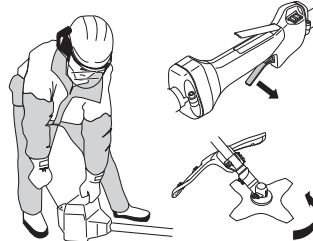

GENEL GÜVENLİK AÇIKLAMALARI

Stop düğmesi

Stop düğmesi, motoru durdurmak için kullanılır.

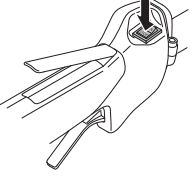

Motoru çalıştırınız ve stop düğmesi stop durumuna getirildiğinde motorun durduğunu denetleyiniz.

Kesme cihazlarının korunması

Bu tür bir koruma, çalışma esnasında kullanıcıya herhangi bir maddenin sıçramasını engeller. Koruma önlemi, aynı zamanda kullanıcının makineyle olan ilişkisini de engeller.

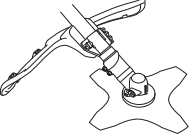

Koruma bölümünün zarar görmemiş olduğundan ve çatlamış veya delinmiş olduğundan emin olunuz. Koruma bölümünde çatlaklar ve yarıklar meydana gelmişse hemen değiştiriniz.

Özel kesim cihazları için daima tavsiye edilen korumaları kullanınız. Teknik veri bölümüne bakınız.



UYARI! Herhangi bir kesme cihazı için, belli bir takım koşullar oluşmamişsa, o taktirde ilgili cihaz, koruma montajı olmayacak şekilde kullanılabilir. Teknik veri bölümüne bakınız. Yanlış veya aktif olmayan koruma montajı, ciddi bir şekilde insanların yaralanmasına neden olabilir.

Titreşimden arındırma sistemi



Makineniz, elden geldiğince, titreşimsiz ve kolay bir kullanıma için tasarlanmıştır. Titreşimden arındırma sistemi ile donatılmıştır.

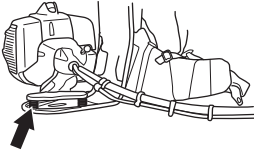

Yanlış sarılan bir halat veya keskin olmayan bir cihazın kullanılması (yanlış tip veya yanlış eğelenmiş bunun için talimatlar bölümündeki eğeleme ve kesme bakınız) titreşimleri artırır.

Makinenizin titreşimden arındırma sistemi, titreşimin motor birimi/kescici araç ile makinenizin sapı arasındaki iletişimini önlemektedir.

Materyal çatlağı ve bozulmalardan sonra titreşimden arındırma elemanını düzenli olarak denetleyiniz. Titreşim engelleyici cihazın tam olduğunu, sabit ve sağlam olarak sıkıca bağlı olduğunu kontrol ediniz.



UYARI! Titreşimlere maruz kalmak, kan dolaşımı bozukluğu bulunan kişilerde, kan damarı veya sinirsel hastalıklara neden olabilir. Titreşimden meydana gelen herhangi bir rahatsızlık durumunda, doktora gidiniz. Örne: bu tür semptomlar, uyuşukluk, duyarlılığı yitirme, gıdıklanmalar, batmalar, ağrılar veya normal gücünü yitirme, derinin yüzeyinin veya renginin değişimi gibi ortaya çıkabilmektedir. Bu tür semptomlar alışı geldiği şekilde, parmaklarda, ellerde veya bileklerde görülür. Düşük ısıda riskler daha fazla artabilir.

Susturucu

Susturucu, olanak elverdiğince, motor saçınlarından kullanıcıyı korumak üzere ve sesin düzeyini düşürmek için yapılmıştır. Katalizatör ile donatılmış susturucu, aynı zamanda gazın içinde bulunan zararlı maddeleri en aza indirmek için donatılmıştır.

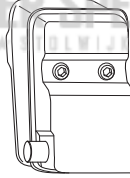

Susturucusu aşınmış bir makineyi asla kullanmayınız.



Susturucunun makinenin içine oturmuş olduğunu düzenli olarak denetleyiniz.

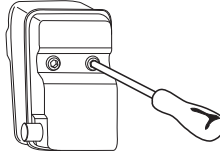

GENEL GÜVENLİK AÇIKLAMALARI

Eğer makinenizin susturucusu kıvılcım tutma ağına sahip ise o da düzenli olarak temizlenmelidir. Yanlış yerleştirilmiş bir ağı motorun ısınmasına ve ciddi biçimde arızalanmasına yol açar.



UYARI! Katalizatör susturucusu çok ısır, bu nedenle makinenin kullanımı sona erdikten sonra sıcaklığı hemen kaybolmaz. Susturucunun ısınması, makine boşta çalışırken de devam eder. Susturucuya dokunmak, deride yaralanmalara neden olabilir. Yanma tehlikesine karşı dikkatli olunuz.



UYARI! Susturucunun içinde kanserojen olabilecek kimyasal maddeler bulunmaktadır. Susturucunun hasar görmesi durumunda bu maddelere temas etmeyin.



UYARI! Düşününki: Egzos dumanları sıcaktır ve yangına neden olabilecek kıvılcımlar da taşıyabilmektedir. Bu nedenle hiçbir biçimde makineyi kapalı yerde ve kolay tutuşabilir maddelerin yakınında çalıştırmayınız!

Kilit cıvata somunları

Bu tip kesici aletlerde sabitleme işlemleri için kilit cıvata somunları kullanılır.



Montaj sırasında cıvata somunlarını, kesme cihazlarının dönme yönüne doğru sıkınız. Sökme sırasında, cıvata somunlarını kesme cihazlarının dönme yönünde sökünüz. (DİKKAT! Cıvata somunları sola doğru yivlidir.) Anahtar kullanarak somunu sıkın.

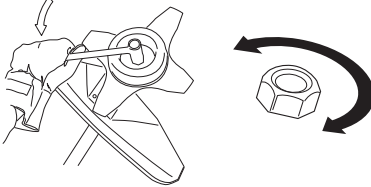

Kilit cıvata somunlarının naylondan yapılmış kilitleri aşınmış olmamalı, elle sıkılabilir durumda olmalıdır. Kilitleme bölümü en az 1,5 Nm'lik bir mesafede olmalıdır. Cıvata somunları ortalama 10 kez vidalandıktan sonra değiştirilecektir.

Kayış

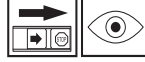

Kayışların zarar görmemiş olduğundan emin olunuz.

Acil bir durumda, kendinizi makineden ve taşıma askısından aşağıdaki yöntemle kurtarın.

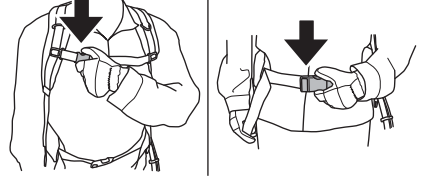

Kesici gereçler

Bu bölüm, aşağıdaki amaçları gerçekleştirmek için uygun kesici gereçlerin seçim ve bakımını nasıl yapacağınızı anlatmaktadır:

- Makinenin geri tepme eğilimini azaltmak.
- En yüksek kesim yeteneğini elde etmek.
- Kesici gereçlerin ömrünü uzatmak.

ÖNEMLİ!

Kesim cihazıyla beraber aynı zamanda bizim tavsiye ettiğimiz koruma cihazını birlikte kullanınız. Teknik veri bölümüne bakınız.

Halatların somut bir şekilde doldurulması ve doğru bir alat birimi seçimi için kesim teçhizatları bölümüne bakınız.

Kesici aletlerin ağız bölümündeki kesme dişlerini çok iyi ve somut bir keskinlikte tutunuz! Lütfen tavsiyelerimize uyunuz. Aynı zamanda, Kesici aletlerin ağız bölümlerinin paketlenmesi ile ilgili talimatlara bakınız.



UYARI! Herhangi bir kesme cihazıyla çalışmaya başlamadan önce daima motoru durdurunuz. Bu işlem aynı zamanda gaz ayar kolunun serbest bırakılması için de geçerlidir. Kesme cihazıyla çalışmaya başlamadan önce, cihazın tamamen durduğunu ve kablosunun ateşleme sisteminden çekilmiş olduğunu kontrol ediniz.



UYARI! Yanlış kullanılan bir kesim cihazı veya yanlış eğelenmiş bir kesme cihazı ağız, cihazın aşırı derecede çalışmasına neden olabilir.

GENEL GÜVENLİK AÇIKLAMALARI

Kesici gereçler

Çim biçme makinesi ve çim biçme bacağı, yüksek ve büyük otların biçme işlemlerinde kullanılır.



Kesme başlığı, çimlerin biçilmesi için kullanılmaktadır.



Temel kurallar



Kesim cihazıyla beraber aynı zamanda bizim tavsiye ettiğimiz koruma cihazınızı birlikte kullanınız. Teknik veri bölümüne bakınız.

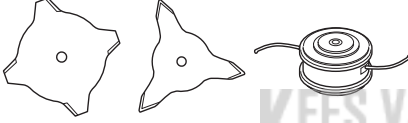

Kesici aletin keskin ağzının dişlerini somut ve iyi bir keskinlikte olmasına sağladık. Bizim talimatlarımıza uyunuz ve bizim tavsiye ettiğimiz araç-gereçleri kullanınız. Yanlış bir şekilde eğelenmiş veya zarar görmüş bir kesici alet kazalara neden olabilir.

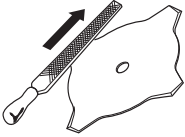

Kesme cihazlarının zarar görüp görmediğini ve çatlama olup olmadığını kontrol ediniz. Zarar görmüş olan kesme cihazı daima değiştirilecektir.

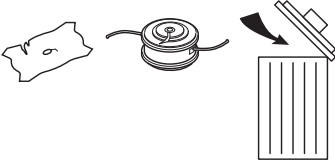

Çim biçme makinelerinin ve çim bıçaklarının eğelenmesi



- Kesme cihazlarının somut bir şekilde eğelenmesi ve paketlenmesi bölümüne bakınız. Kesme cihazı ve bıçaklar tek yönlü düz bir eğe ile eğelenecektir.
- Kesici aletlerin keskin ağzılarını eşit ölçüde eğelleyiniz ve bu şekilde dengeyi sağlayınız.

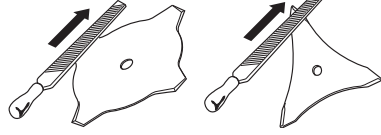

UYARI! Eğik, kırık veya zarar görmüş testereleri iskartaya çıkararak atınız. Eğik ve kırık bir testereyi asla yeni bir işlem için kullanmayınız. Yalnızca talimatta yazılı bulunan tipteki orijinal kesicileri kullanınız.

Kesme başlığı

ÖNEMLİ!

Kesme halatının, silindiri daima sert ve eşit bir şekilde sarmasına dikkat ediniz, aksi takdirde makineyi tehlikeli bir şekilde yıpratabilecek titreşimler meydana gelebilir.

- Yalnızca tavsiye edilen kesme halatlarını ve kesme başlıklarını kullanınız. Bu araçlar, belli bir motor büyüklüğüne uygun olması açısından üretici tarafından test edilmiştir. Otomatik bir kesme başlığının kullanılması özel olarak önem taşımaktadır. Yalnızca tavsiye edilen kesim teçhizatlarını kullanınız. Teknik veri bölümüne bakınız.



- Genel olarak küçük makinelerde, küçük kesme başlıkları istenmektedir. Kesme halatı nedeniyle, motor, halatı, kesme başlığından dışarıya fırlatmakta ve aynı zamanda kesilen çime karşı koymak zorunda kalmaktadır.
- Halatın uzunluğu da aynı şekilde önem taşımaktadır. Uzun bir halat, aynı çapta olan daha kısa bir halatın gerek duyduğu motor gücünden daha fazla bir motor gücü gerektirir.
- Bıçağın kesme koruma bölümüne bozulmayacak bir şekilde oturmasına dikkat ediniz. Bu, halatların doğru bir şekilde kesme işlemlerinde kullanılır.
- Halatların daha uzun bir süreyle kullanılabilmesini sağlamak için birkaç gün suyun içinde tutunuz. Bu şekilde halat daha dayanıklı ve kullanışlı olacaktır.

Esnek hareket milini takma



- Mil bağlantısındaki iki vidayı gevşetin.

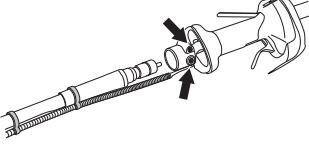

- Esnek mili, kablolardaki halkalardan kaydırın ve esnek mili, mil bağlantısına takın. Mili iterken aynı zamanda döndürerek doğru şekilde geçtiğinden emin olun.
- Dört vidayı sıkın.
- Delik, kavrama kapağının üstündeki kilitleme düğmesinin doğrudan altına yerleşecek şekilde, hareket mili rakorumu kavrama kapağına takın.

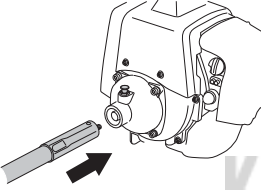

- Mili iterken aynı zamanda döndürerek doğru şekilde geçtiğinden emin olun.
- Kilit piminin orijinal konumuna geri dönerek, hareket mili rakorumun kavrama muhafazasından çıkmasını sağlayın.

Gaz kablosunu ve durdurma düğmesi kablolarını takma



- Kablodan (A) gaz telini ve motordan (B) gaz telini, plastik rakora gösterildiği gibi yerleştirin.

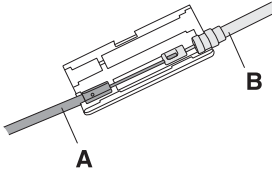

- Plastik rakoru kapatın.

- Durdurma düğmesi kablolarını motordaki ilgili konektörlere takın. Kablo kutuplarının önemli olmadığını unutmayın.

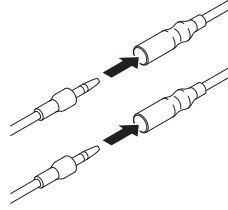

J-tutamağı takma



- Gidonu borunun üstüne yerleştirin. Elçiğin borunun üstündeki okun altına takılması gerektiğine dikkat edin.

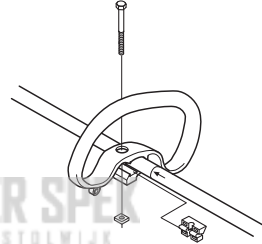

- Vida başlarındaki kanalları tutamakta bulunan boşluğa doğru itiniz
- Somunu ve vidayı takın. Gereğinden fazla sıkmayın.
- J-tutamağı, gösterildiği gibi üç vida kullanarak yarım daire şeklindeki tutamağa takın.

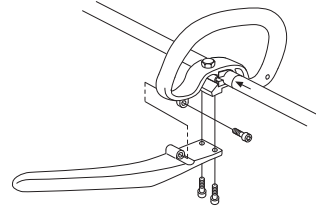

MONTAJ

- Şimdi, kesicinin en iyi çalışmayı yürütecek şekilde bir ayar yapınız. Vidaları sıkınız.

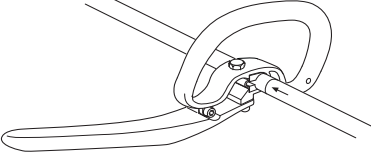

UYARI! J-tutamak takılıken sadece çim biçme makineleri/çim bıçakları veya kesici başlıklar/plastik bıçaklar kullanılabilir. J-tutamakla asla testere bıçakları kullanılmamalıdır.

Keskin alet ağzlarının ve başlıklarının montaj işlemi



UYARI! Kesme cihazlarının monte işlemlerinde ayrıca, destek aracının kesme cihazı içinde doğru bir şekilde monte edilmesi de önem taşımaktadır. Kesme cihazının yanlış monte edilmesi, ciddi bir şekilde, hayatı tehlikeye düşürerek yaralanmalara neden olabilir.

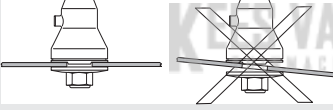

UYARI! Herhangi bir kesme cihazı için, belli bir takım koşullar oluşmamişsa, o takdirde ilgili cihaz, koruma montajı olmayacak şekilde kullanılabilir. Teknik veri bölümüne bakınız. Yanlış veya aktif olmayan koruma montajı, ciddi bir şekilde insanların yaralanmasına neden olabilir.

ÖNEMLİ! Testere veya çim kesici kullanabilmek için, makinenin doğru bir dümen, keskin ağız koruyucu ve kayışla donatılmış olması gerekmektedir.

Muhafaza uzatma parçasının takılması



DİKKAT! Kesici başlık/plastik bıçaklar ve kombinasyon muhafazası kullanılırken muhafaza uzatma parçası mutlaka takılmalıdır. Çim biçme ağız ve kombinasyon muhafazası kullanılırken muhafaza uzatma parçası mutlaka sökülmelidir.

Kesici ağız koruma kısmı/iki amaçlı koruma kısmı (A) bir çengel ile araca sabitlenir ve bir vida ile sağlanmaktadır.

Muhafaza uzatma parçası kılavuzunu, kombinasyon muhafazasındaki yuvaya takın. Ardından, dört hızlı sabitleme

parçasını kullanarak muhafaza uzatma parçasını muhafaza üzerindeki konumuna takın.

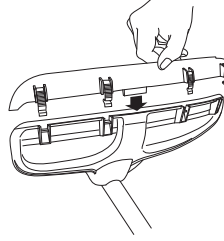

Koruyucunun uzatma parçası, ilgili resimde de görüldüğü gibi tornavida yardımıyla kolayca çıkarılabilir.

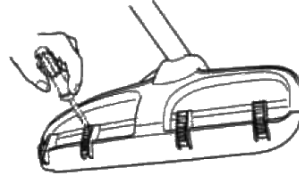

Kesici ağız koruyucu, çim biçme ağız ve çim biçme aracının keskin ağızlarının korumasının montajı



- Kesici ağız koruma kısmı/iki amaçlı koruma kısmı (A) bir çengel ile araca sabitlenir ve bir vida ile sağlanmaktadır (L). Daima tavsiye edilen keskin ağız korumasını kullanınız. Teknik bilgiler bölümüne bakınız. **DİKKAT!** Muhafaza uzatma parçasının söküldüğünden emin olun.

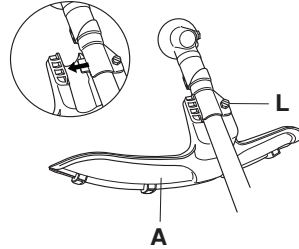

- Beraber getirilen (B) cihazını sırt kısmına monte ediniz.
- Cihazın keskin kısmının sırt kısmını makas (bağlantı) yerindeki deliğe uygun gelinceye kadar döndürünüz.
- Kilit çubuğunu (C) cihazın sırt (dingil) kısmını kilitleyecek şekilde deliğin içine iterek sokunuz.
- Kesiciyi (D) ve destek fincanlarını (E) ve yırtma desteğini (F) dingiller üzerine monte ediniz.
- Cıvata somunlarını monte ediniz (G). Cıvata somunları 35-50 Nm (3,5-5 kpm) büyüklüğündeki anahtarla sıkılmalıdır. Araç, gereçlerin içinden somun anahtarını kullanınız. Somun anahtarının sapını, kesici başlığa mümkün olduğu kadar yakın tutunuz. Anahtar, eksen üzerinde bulunan

MONTAJ

dönme yönüne doğru götürüldüğünde cı vata somunu sıkı malıdır (DİKKAT! sol yönde vidalanmalıdır).

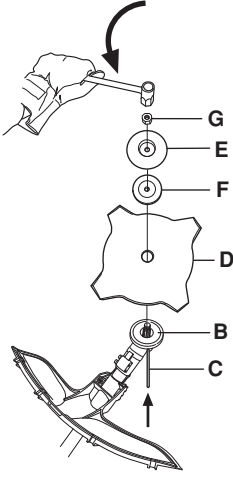

Kesici başlık korumasının ve kesici başlığın montajı



- Kesme başlığı ile çalışmaya başlamak için kesici koruma (A)yı monte ediniz. DİKKAT! Muhafaza uzatma parçasının takılı olduğundan emin olun.

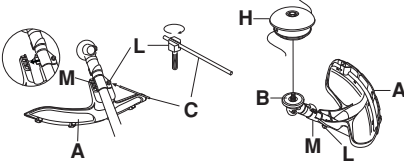

- Kesici koruma/kombi koruma bir çengel ile araca sabitlenir ve bir vida ile sıkılarak sağlamlaştırılır (L)
- Beraber getirilen (B) cihazı sırt kısmına monte ediniz.
- Cihazın keskin kısmının sırt kısmını makas (bağlantı) yerindeki deliğe uygun gelinceye kadar döndürünüz.
- Kilit çubuğunu (C) cihazın sırt (dingil) kısmını kilitleyecek şekilde deliğin içine iterek sokunuz.
- Kesici başlık/plastik bıçaklar (H) eksen üzerindeki dönme yönüne doğru vidalanarak sabitlenir.

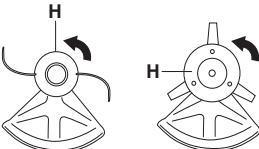

- Talimata uygun olmayacak şekilde yapılan montaj işlemleri ters sonuçlanabilir.

Nakliye koruyucusunu takma



- Bıçağı taşıma muhafazasına yerleştirin (A).
- Taşıma muhafazasını sabitlemek için iki sabitleme turnağını (B) yuvalarına (C) oturtun.

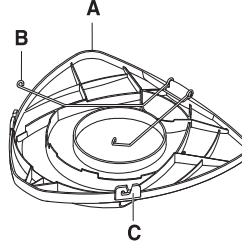

Temizlik testeresine kayış uyumu



Arka plaka yüksekliğinin ayarlanması

- Arka plakayı tutan iki bağlayıcıyı gevşetin.



- Arka plakayı bir tarafında şasiden ayırın.

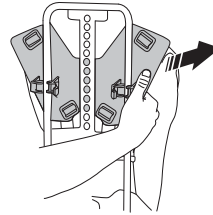

MONTAJ

- Arka plakayı istenilen yüksekliğe getirin ve sabitleyin. Pimin şasideki deliklerden biriyle hizalanmasını temin edin.

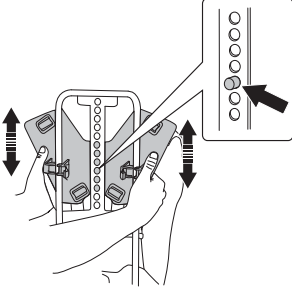

Kayışın ayarlanması

- Kayışı takın.
- Bel kayışını güvenli biçimde oturacak şekilde sıkın.



- Göğüs kayışını sıkın.



- Gerekirse göğüs kayışını dikey olarak ayarlayın ve sıkıca oturmasını temin edin.

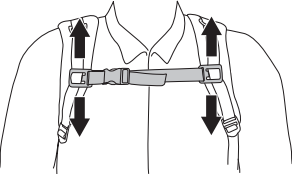

- Yükyü omuzlarınıza eşit biçimde dağıtacak şekilde omuz kayışlarını ayarlayın.



- Yükyü %70'i belinizde ve %30'u omuzlarınızda olacak şekilde bel kayışını gevşetin veya sıkın.

KEES VAN DER SPEK
TUINMACHINES * STOLWIJK

YAKIT KULLANIMI

Yakıt güvenliği

Aşağıdaki durumlarda makineyi asla çalıştırmayınız:

- 1 Eğer motorun yakıt tankına doldurduğunuz yakıttan, yakıt döküntüsü varsa: Dökülen bütün yakıtı siliniz ve kalan benzinin buharlaşmasını bekleyiniz.
- 2 Eğer yakıt döküntüsü size veya elbisenize bulaşırsa, hemen elbisenizi değiştiriniz. Yakıt döküntüsü ile temas eden vücudunuzun bölümlerini hemen yıkayınız. Yakıt döküntüsü ile temas eden vücudunuzun bölümlerini sabun ve suyla yıkayınız.
- 3 Yakıt sızdırıyorsa. Depo kapağı ve yakıt kablolarında sızma olup olmadığını düzenli olarak denetleyiniz.

Taşıma ve saklama

- Makineyi ve yakıtı, kıvılcım ve alev sızıntısı riskinin olmadığı, örn: elektrik makinelerinin, elektrik motorlarının, elektrik kontağının/elektrik düğmesinin veya ısı dağıtım merkezlerinin bulunmadığı ortamlarda muhafaza ediniz ve taşıyınız.
- Yakıtın taşınması ve korunmasında yalnızca özel olarak tavsiye edilen ve onaylanmış bulunan araçlar kullanılacaktır.
- Makinenin uzun süre koruması durumunda, yakıt tankı, mutlaka boşaltılmalıdır. En yakındaki benzin istasyonu ile temasa geçerek elinizdeki benzin fazlasını ne yapmanız gerektiğini sorunuz.
- Makinenin içice temizlenmiş olmasına ve onu uzun süreli koruma altına almadan önce tümüyle yetkili servis denetiminden geçmiş olmasına özen gösteriniz.
- Makinenin taşınması veya korunması sırasında, kesme aracının transport koruması mutlaka monte edilmiş olmalıdır.
- Nakliye sırasında makineyi emniyete alın.



UYARI! Yakıtı taşıırken çok dikkatli olunuz. Patlama ve yanma riskinin olabileceğini düşününüz.

Çalıştırıcı

DİKKAT! Makine, iki zamanlı bir motorla donatılmış olup, her zaman benzin ve iki zamanlı motor yağı karışımı kullanılarak çalıştırılmaktadır. Doğru karışımın elde edilebilmesi için karıştırılacak yağ miktarının hassas şekilde ölçülmesi önemlidir. Az miktarda yakıt karıştırılıyorsa, küçük yanlışlıklar bile karışımındaki oranları belirgin şekilde etkileyebilir.



UYARI! Yakıt ve yakıt buharı kolay ateş alır ve tenefüs edildiğinde veya cildinizle temas ettiğinde ciddi yaralanmalara yol açabilir. Bu nedenle yakıt işlemlerinde azami derecede dikkatli olmalı ve yeterli havalandırma olmasına özen göstermelisiniz.

Benzin



DİKKAT! Her zaman en az 90 oktanlık (RON) kaliteli benzin/yağ karışımları kullanın. Makinenizde katalitik dönüştürücü (Teknik veriler bölümüne bakın) mevcutsa her zaman iyi kalitede kurşunsuz benzin/yağ karışımı kullanın. Kurşunlu benzin katalitik dönüştürücüyü bozar.

Bunu çevreye uyumlu benzin olarak adlandırabiliriz soğuk durumdaki benzinden de yararlanılabilir.

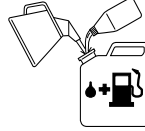

- Önerilen en düşük oktan 90'dır (RON). Motoru 90'dan daha düşük oktanlı yakıtla çalıştırırsanız, motor tekler. Bu nedenle motor çok fazla ısınır, bu da motorda ciddi zarara yol açabilir.
- Sürekli yüksek devirde yapılan çalışmalarda yüksek sayıda oktan bulunan yakıt kullanılması tavsiye edilir.

İki-strok yağı

- En iyi sonuç ve performans için hava soğutmalı, iki zamanlı motorlar için özel olarak üretilen HUSQVARNA iki zamanlı motor yağlarını kullanın.
- Su soğutmalı harici motorlar için üretilmiş, harici yağ (TCW) olarak da anılan iki zamanlı motor yağlarını asla kullanmayın.
- Dört çekişli motorlar için imal edilmiş olan yağları kesinlikle kullanmayınız.
- Düşük yağ kalitesi veya fazla zengin yağ/yakıt karışımı katalitik dönüştürücünün işlevine zarar verir ve hizmet ömrünü azaltır.
- Karıştırma oranı
HUSQVARNA iki zamanlı yağ içeren 1:50 (%2).
JASO FB/ISO EGB olarak sınıflandırılmış hava soğutmalı, iki zamanlı motorlar için tasarlanmış yağlar ile 1:33 (%3).

Benzin, litre	İki-strok yağı, litre	
	2% (1:50)	3% (1:33)
5	0,10	0,15
10	0,20	0,30
15	0,30	0,45
20	0,40	0,60

YAKIT KULLANIMI

Karışım

- Benzin ve yağ her zaman, benzin için uygunluğu onanmış, temiz bir kapta karıştırılır.
- Her zaman, karıştırılacak olan benzinin yarısını karıştırarak işe başlayınız. Daha sonra yağın tümünü dökünüz. Yakıt karışımını katıştırınız (çalkalayınız). Daha sonra geri kalan benzinini dökünüz.
- Makinenin yakıt deposu dolmadan önce yakıt karışımını özenle katıştırınız (çalkalayınız).

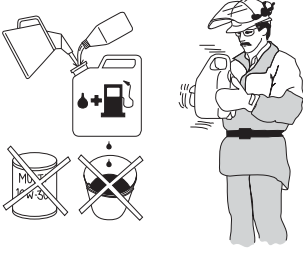

- Bir aylık bir ihtiyaçtan daha fazla yakıt karıştırmayınız.
- Eğer makine uzun bir süre kullanılmıyacaksa yakıt deposu boşaltılıp temizlenmelidir.



UYARI! Katalitik konvertör egzosu, aletin kullanıldığı sırada ve kullanımdan sonra çok sıcak olur. Aynı durum rölantide de söz konusudur. Makineyi özellikle yanıcı maddelerin ve/veya gazların yakınında kullanacağınız zaman yangın tehlikesini göz önünde tutunuz.

Yakıt ikmali



UYARI! Aşağıdaki önlemler yangın olasılığını azaltır.

Yakıtın yakınında sigara içmeyiniz ve/veya sıcak bir cisim bulundurmuyunuz.

Motor çalışırken yakıt ikmali yapmayınız.

Yakıtı doldurmadan önce motoru durdurun ve motorun soğumasını bekleyiniz.

Yakıt doldururken, olası bir fazla basıncın yavaşa kaybolması için depo kapağını yavaşa açınız.

Yakıt ikmalinden sonra depo kapağını iyice sıkıştırarak kapatınız.

Başlamadan önce mutlaka makineyi doldurma alanından ve kaynağından uzaklaştırın.

- Yakıt tankını, doldurucu koruyucusu ile beraber kullanınız.
- Yakıt deposunun kapağını kurulumuz ve temizleyiniz. Yakıt deposunun çevresindeki kirler çevre kirliliğine neden olur.
- Yakıt deposunu tam olarak doldurmadan önce kabı sallayarak tam olarak karıştırdığınızdan emin olunuz.

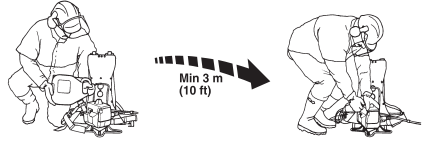

ÇALIŞTIRMA VE DURDURMA

Başlamadan önce kontrol yapınız.



- Korumasız veya aktif koruması bulunmayan makineyi asla kullanmayınız.
- Kapaklarda aynı zamanda somut bir şekilde monte edilmiş olacak ve makine çalışmaya başlamadan önce hatasız olacaktır.
- Keskin ağız kontrol ediniz, ağız kısmındaki dişlerin diplerinde çatlakların oluşmadığından ve merkezi çukur kısmında yarıkların bulunmadığından emin olunuz. Çatlakların oluşmasında alışa gelmiş sebeplerin arasında, eğeleme sırasında keskin ağız dişlerinin diplerinde bulunan köşelerin kazınması veya kesici aletin kör dişlerle kullanılması sayılabilir. Çatlarlar ve yarıkları bulunan kesici teçhizatı kullanmayınız.

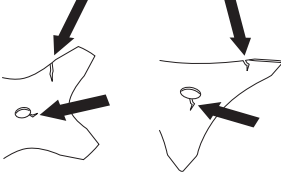

- Destek teçhizatını kontrol ederek çok fazla çalışmadan dolayı veya sert ve kuvvetli vidalamalardan ötürü çatlaklar oluşmadığından emin olunuz. Çatlaklar ve yarıkları bulunan kesici teçhizatı kullanmayınız.

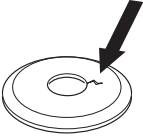

- Cıvata somunlarının, kilitleme gücünü yitirmediğini kontrol ediniz. Cıvata somunlarının kilitleme momenti en az 1,5 Nm olmalıdır. Cıvata somunlarının vidalama momenti 35-50 Nm olmalıdır.



- Keskin ağız korumasını kontrol ederek zarar görmemiş olmasına ve çatlakları bulunmamasına özen gösteriniz. Keskin ağız korumasında çatlaklar olması veya darbeye maruz kalması durumunda hemen değiştiriniz.

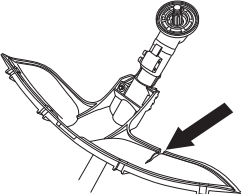

- Kesme başlığı ve kesme başlığı koruyucusunu kontrol ediniz ve çatlakları bulunmadığından veya zarar görmemiş

olduğundan emin olunuz. Darbeye maruz kalmış veya çatlamış olan kesme başlığı veya kesme koruyucusu hemen değiştiriniz.

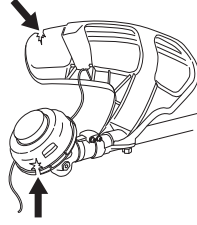

Çalıştırma ve durdurma



UYARI! Makineyi çalıştırmaya başlamadan önce, debriyaj ile teçhizat borusunun bir arada monte edilmesi gerekir aksi takdirde debriyaj boşalabilir ve insanların yaralanmasına neden olabilir.

Başlamadan önce mutlaka makineyi doldurma alanından ve kaynağından uzaklaştırın. Makineyi sabit bir zemin üzerine yerleştiriniz. Kesme cihazının içine herhangi bir şeyin kaçmamasına veya girmemesine özen gösteriniz.

Yetkili olmayan kişi veya kişilerin çalışma alanına girmemesine özen gösteriniz, aksi takdirde bu insanların yaralanmaları riski almış olursunuz. Güvenlik mesafesi 15 metre

Çalıştırma



Ateşleme: Başlangıç noktasıyla "stop" ilişkisini kurunuz.

Yakıt pompası: Yakıt pompasının kauçuk torbasına, yakıt dolmaya başlayınca kadar defalarca basınız. Kauçuk torbanın tamamen dolmasına gerek yoktur.

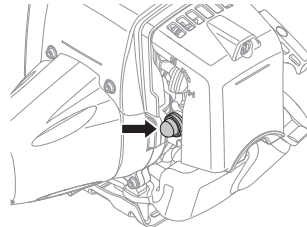

ÇALIŞTIRMA VE DURDURMA

Jikle: Jikleyi jikle durumuna getiriniz.

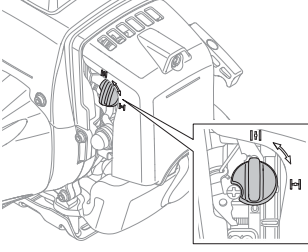

UYARI! Motor jikle ayar kolu veya gaz başlangıç kolu ile çalışmaya başladığında kesme cihazı hemen dönmeye başlar.

Makinenin gövdesini toprağa doğru sol elinizle bastırınız (**DİKKAT!** Kesinlikle ayağınızla basmayınız!) Başlama kolunu tutunuz, başlama halatını sağ elinizle size bir karşı koyma hissedinceye kadar yavaşça dışarıya doğru çekiniz (başlama çengelleri içeri doğru tutulur) ve daha sonra ani ve sert hareket ediniz. **Çalıştırma ipini hiçbir zaman elinize dolamayınız.**

Motor çalışmaya başladığında jikle ayar kolunu tekrar eski konumuna getiriniz ve motor çalışıncaya kadar yeniden deneyiniz. Motor çalışmaya başladığında tam gaz veriniz bu şekilde başlama gazı otomatik olarak bağlanacaktır.

DİKKAT! Çalıştırma ipini tümüyle dışarı doğru çekmeyiniz ve tümüyle dışarı doğru çekilmiş durumdayken elinizden bırakmayınız. Bu durum, makinenin arızalanmasına yol açabilir.

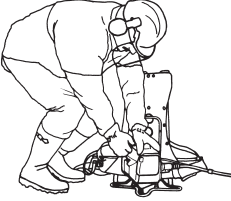

DİKKAT! İşaretli alana hiçbir şekilde dokunmayın. Bu alanla temas, yanıklara veya buji kapağı hasarlıysa, elektrik çarpmasına neden olabilir. Her zaman olduğu gibi eldiven kullanın. Buji kapağı hasarlı makineyi kullanmayın.

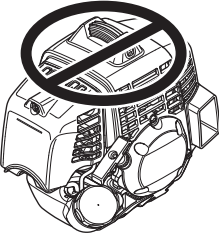

Stop



Ateşleme kesilince motor durur.

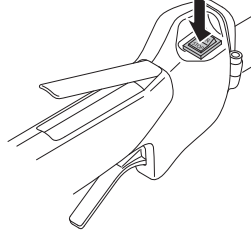

ÇALIŞMA TEKNİKLERİ

Genel çalışma açıklamaları

ÖNEMLİ!

Bu bölüm, temizlik testeresi ve kesicilerle çalışmayla ilgili temel güvenlik kurallarını ele almaktadır.

Cihazın kullanılması esnasında, emin olmadığınız herhangi bir durumla karşılaşırsanız bir bilirkişiye danışınız. Bu durumda satıcıyla veya servisinizle temasa geçiniz.

Yeterli derecede kaliteli olmayan ve çok zor ustalık gerektiren ürünleri kullanmaktan kaçınınız.

Makineleri kullanmaya başlamadan önce, orman testeresi, çim biçme makinesi ve çim kesicileri arasındaki farkı anlamamız gerekir.

Temel güvenlik kuralları



1 Çevrenize dikkat ediniz:

- İnsan, hayvan ya da başka birşeyin, makine üzerindeki denetiminizi engelleyemeyeceğinden emin olunuz.
 - İnsanların, hayvanların veya diğerlerinin yola bırakılan kesici cihazlarla temasının önlenmesi için, daima dikkatli olunuz.
 - DİKKAT! Herhangi bir kaza durumunda, yardım olmadan asla bir daha makineyi çalıştırmayınız.
- 2 Çalışma alanını kontrol edin. Taş, cam kırıkları, çivi, tel, ip, vs. gibi etrafa sıçrayabilecek veya kesme donanımına takılabilecek tüm maddeleri temizleyin.
- 3 Kötü hava koşullarında çalışmaktan kaçınınız. Örneğin yoğun sis, kaygan zemin, ağacın düşme yönünü etkileyecek hava koşulları v.b. Kötü havada çalışmak yorucudur ve kaygan zemin, ağacın düşme yönü v.b. gibi konularda, tehlikeli koşullara neden olabilir.
- 4 Hareket edebilme ve ayakta durabilme olanağınızın olmasına özen gösteriniz. Olası engellere (kök, taş, dal, çukur v.b.) dikkat ediniz. Kapalı bir arazide çalışırken çok dikkatli olunuz.



- 5 Bu sırt çantası tipi üfleyciyi çalıştırırken her zaman omuzda taşıma askısı üzerinde taşıyın.
- 6 Dengenizi iyi sağlayın ve yere sağlam basın.
- 7 Makineyi her zaman iki elinizle tutun.
- 8 Kesme donanımını bel hizasının altında tutun.
- 9 Makinenin yanından ayrılma veya makinenin taşınması durumunda motor mutlaka durdurulmalıdır. Sık sık taşınması durumunda, veya uzun seyahatlerde makinede daima transport koruma kullanılmalıdır.

10 Makinenin motorunu, kullanmadığınız zaman ve yanında bulunmadığınız zaman çalışır vaziyette bırakmayınız.



UYARI! Ciddi yaralanmalara yol açabileceğinden motor çalışırken veya kesici kısım dönerken makineyi kullanan kişi veya başka herhangi biri kesilmiş parçaları almaya çalışmamalıdır.

Bıçak shaftının etrafına sarılmış malzemeleri çıkarmadan önce motoru ve kesme düzeneğini durdurun, aksi halde çok tehlikelidir. Makinenin belli bir süreyle kullanılmasından sonra, dingil açısı ısınabilir. Buna dokunulduğunda yanma sonucunda oluşabilecek yaralanma riski meydana gelebilir.



UYARI! Fırlayan, sıçrayan parçalara dikkat edin. Her zaman onanmış koruyucu gözlükler takın. Kesme donanım koruyucusunun üstünden sarkmayın. Taş, kıymık, vs. gözlere gelenek körlüğe veya önemli yaralanmalara neden olabilir.

Yetkili olmayan kişiler kesim alanının dışında tutunuz. Çocukları, hayvanları, kesimi izleyen izleyicileri ve kesime yardımcı olan kişileri, kesim esnasında güvenli bölgenin 15 metre uzağında tutunuz. Herhangi bir kişi makineye yaklaştığında, hemen makineyi durdurunuz. Güvenlik bölgesinin içinde kesim yaparken, arkamıza bakmadan ve herhangi birisinin olup olmadığını kontrol etmeden sağa-sola dönmeyiniz.

Çalışma tekniğinin temeli

Her mola esnasında, makinenin motorunu boş devire getiriniz. Makinenin motorunu tam devirde uzun süreli çalıştırmayınız. Motor tam yüklenmeden yapılan bu tür çalıştırmalar, motora ciddi bir şekilde zarar verebilir.



UYARI! Bazen dallar veya çimler, koruyucu bölme ile kesme cihazı arasında kalabilir. Makinenin temizliği yapılırken daima motoru durdurunuz.



UYARI! Testere bıçağı veya çim bıçağı takılı makineler, bıçak sabit bir nesneye temas ettiğinde şiddetle yan tarafa savrulabilir. Buna bıçak savrulması denir. Bıçak savrulması, makinenin ve/veya kullanıcının herhangi bir yöne sürüklenmesine ve makinenin kontrolünün kaybedilmesine neden olabilir. Makine bir çukura takılırsa, duraklarsa veya önünde bir engel varsa, bıçak savrulması uyarısız gerçekleşebilir. Kesilen malzemenin zor görüldüğü alanlarda, bıçak savrulmasının gerçekleşme olasılığı daha fazladır.

Kesim bölgesinde saat 12 ile 3 arasında testere ile kesim yapmaktan kaçınınız. Kesme cihazının dönme (devir) hızından dolayı, çalışma bölgesine kalın kökler sıçrayabilir.

ÇALIŞMA TEKNİKLERİ

Çim biçme makineleri ve çim biçme



- Çim biçme makineleri, odun kesme işleminde kullanılmamalıdır.
- Uzun ve sert çimlerin her türlüünde mutlaka çim biçme makinesi kullanılmalıdır.
- Çimler saat sarıkası gibi yanlara doğru yayılan hareketlerle biçilir, bu işlem sağdan sola temizlik hareketi ve soldan sağa geriye dönüşlü hareketlerle sağlanır. Biçme makinesini kullanırken, kesici kısmın sol kısmında (saatin 8 ve 12 arasında) çalışmasına dikkat ediniz.

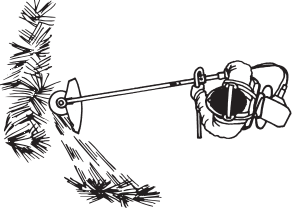

- Eğer kesici, çim biçme işlemi sırasında sol kısma meyilli olarak çalışırsa, çimleri şiddetli bir şekilde belli bir yere toplar, bu işlem örn: trmık ile çimlerin toplanmasını daha kolay bir hale getirir.
- Ritmik olarak yapılan çim biçme işleminden sonra. Ayakta dik ve sabit bir şekilde durunuz. İleriye ve geriye doğru giderek tekrar hareketsiz bir şekilde durunuz.
- Destek fincanların çıkarınız ve arazinin üstüne bırakınız. Bu işlem çim biçme makinesini arazinin çeşitli etkilerinden korur.
- Aşağıda belirtilen kurallar uyararak, cihazın çinlamaya benzer ses çıkarma riskini azaltınız:
1Daima ful yakıtla çalışınız.
2Geriye dönüş hareketlerinde, yivli araçlardan uzak durmaya özen gösteriniz.
- Motoru durdurunuz, kayışları çıkarınız ve cihazın yivli kısımlarını toplamadan önce makineyi toprağın üstüne yerleştiriniz.

Kesme başlığı ile çim biçme



Kesme

- Kesme başlığını çimlerden uzaklaştırınız ve belli bir açıyla yaslanmış durumda tutunuz. Halatın son kısmı işlemi yerine getirmektedir. Halatın kendi temposunda çalışmasını sağlayınız. Halatın içine herhangi bir maddeyi sokmayınız.



- Halat, çimleri ve çim olmayan diğer maddeleri duvarlara, çitlere, ağaçlara ve çiçeklere doğru fırlatır, aynı zamanda ince ağaç kabuklarına, çalılara ve çitlerdeki direklere zarar verebilir.
- Halat uzunluğunu 10-12 cm civarında kısaltarak ve motor devrini düşürerek ot ve bitki budarken meydana gelebilecek yaralanma riskini azaltınız.

Kazıyarak temizleme

- Kazıma tekniği ile yapılan temizlik, arzu edilmeyen bütün bitkileri temizler. Kesici başlığı toprağın üstüne koyunuz ve yaslayınız. Halatın son kısmını ile, ağacın çevresindeki çubuk ve benzeri şeyleri kesip biçiniz. DİKKAT! Bu teknik, halattaki aşınmayı artırır.



- Halat çubuk aşındığından, taş, tuğla, beton, metal direk ve benzeri çalışmalarda, çubuk ve tahtalarla temaslarda malzemeyle donatmak gerekir.
- Kesme ve kazıma işlemlerinde, motora tam gaz vermeden çalışma yapınız. Bu şekilde halat daha uzun bir süreyle aşınmadan kullanılabilecek ve kesme başlığı da daha az yıpranacaktır.

Kesme

- Tıraş etme işlemi, alış gelmiş bir çim biçme makinesinin zorlukla yapabileceği kesme işlemleri ve yerleri için ideal bir uygulamadır. Kesme işlemi sırasında halatı toprağa paralel gelecek şekilde tutunuz. Kesici başlığı aşağıya doğru bastırmaktan kaçınınız, çünkü bu şekilde çimlere ve araç-gerece zarar verebilirsiniz.

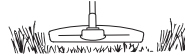

- Normal bir kesim sırasında, kesme başlığının sürekli toprakla ilişkili olmasını engelleyiniz. Bu tür uygulamalar, kesme başlığının aşınmasına ve bozulmasına neden olabilir.

Süpürme

- Döner halatın hafif rüzgar etkisi, çabuk ve tek yönlü basit temizlik için kullanılabilir. Halatı, temizlik yapılacak yüzeyin ve araçların üstüne paralel gelecek şekilde tutunuz ve ileri geri hareket ettiriniz.

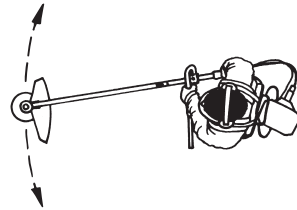

- İyi bir sonuç elde edebilmek için motoru tam gaz olarak çalıştırınız.

Karbüratör

Rölanti devrini ayarlama (T)

Hava filtresinin temiz olmadığını kontrol edin. Rölanti devri doğru olduğunda kesicinin dönmemesi gerekir. Ayar yapılması gerektiğinde, motor çalışırken, T vidasını kesici dönmeye başlayana kadar saat yönünde sıkıştırın. Vıdayı, kesici durana kadar saatin tersi yönünde açın. Motor her türlü konumda düzgün çalışıp kesicinin dönmeye başlamasını sağlayacak devir hızına yeterli bir aralık olduğunda doğru rölanti devri sağlanmış olur.

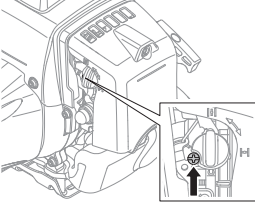

UYARI! Kesme cihazınızın çalışmamasından dolayı boş devir ayarı yapılamıyorsa satıcınızla/servisinizle ilişki kurunuz. Somut bir kurma veya onarım olmadığı sürece makinenizi kesinlikle kullanmayınız.

Hava filtresi



Aşağıdakilerden kaçınmak için hava filtresi toz ve kirden arındırılmalı ve düzenli olarak temizlenmelidir:

- Karbüratör arızaları
- Çalıştırma sorunları
- Motor gücünün azalması
- Motor parçalarında gereksiz aşınması
- Anormal ölçüde fazla yakıt tüketimi.

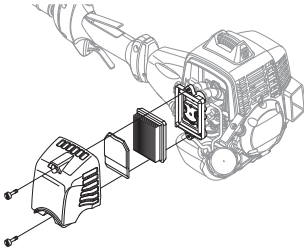

Her 25 saatlik çalışmadan sonra filtreyi temizleyiniz veya bu işlemi tozlu çalışma koşullarına göre daha sık uygulayınız.

Hava filtresinin temizlenmesi

Hava filtresi kapağını söktünüz ve filtreyi dışarıya çıkarınız. Hava filtresini sıcak suyla ve banyo sabunuyla yıkayınız. Filtreyi kurduktan sonra tekrar yerine takarak monte ediniz.

Uzun süre kullanılmış bir hava filtresinin büsbütün temizlenmesi olanaksızdır. Bundan ötürü filtre, düzenli aralıklarda yenisiyle değiştirilmelidir. **Bozuk bir hava filtresi kesinlikle değiştirilmek zorundadır.**

Yakıt filtresi

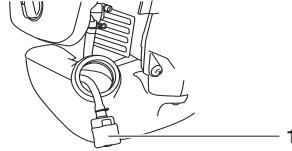

1 Yakıt filtresi

Motora giden yakıt azalır, yakıt kapağında ve yakıt filtresinde tıkanma olup olmadığını kontrol edin.

Debriyajlar



Debriyajlar fabrika çıkışı olarak, güvenli bir miktardaki yağla yağlanmışlardır. Makine kullanmaya başlamadan önce kontrol edilerek debriyajlar 3/4 kısmının yağla dolu olduğu görülmelidir. Debriyajlar yağı için özel HUSQVARNA yağını kullanınız.

Debriyaj yağı, normal olarak olası bir tamir durumu söz konusu olmadıkça değiştirilmemelidir.

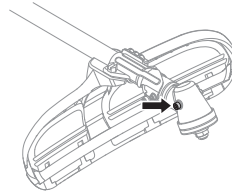

Buji



Aşağıdaki durumlar bujinin kondisyonunu etkiler:

- Yanlış ayarlanmış bir karbüratör.
- Yakıttaki hatalı bir yağ (az veya çok) karışımı motora zarar verir.
- Kirli bir hava filtresi.

BAKIM

Bu faktörler bujinin elektrotlarında artıklara yol açar ve çekiş bozuklukları ile çalıştırma zorluklarına neden olabilir.

Bıçkının etkinliği düşüğe, çalıştırmada zorlanıyorsa ya da motor boşta çalışırken teklilyorsa: başka önlemlere başvurmadan, öncelikle bujiyi denetleyiniz. Buji kirliyse, temizleyiniz ve elektrot aralığının 0,6-0,7 mm olduğunu denetleyiniz. Buji bir ay kadar çalıştıktan sonra veya gerekirse daha önce değiştirilmelidir.

0,6 - 0,7 mm

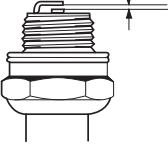

DİKKAT! Her zaman önerilen buji tipini kullanınız! Yanlış buji, kömür/silindir tahribine neden olur. Bujiye süpresör takılı olduğundan emin olun.

Tahrik mili



Esnek tahrik dingili Husqvarna tahrik dingili yağıyla yağlanır. Aks en az 6 ayda bir yağlanmalıdır.

- Hareket milini kavrama kapağında tutan kilitleme düğmesini yukarı kaldırın.

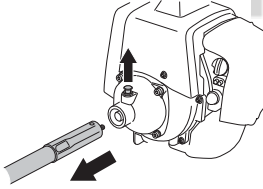

- Hareket mili rakorunu, kavrama kapağından dışarı çekin.
- Hareket milini sallayarak veya penseyle çekerek kovandan dışarı çıkarın.

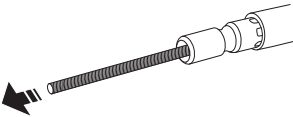

- Aksın tamamına tüpten yağ sürün. Bir fırçayla veya bezle dağıtın.

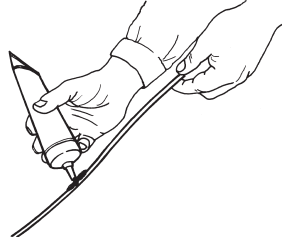

- Hareket milini tekrar kovanın içine kaydırın. Mili iterken aynı zamanda döndürerek doğru şekilde geçtiğinden emin olun.

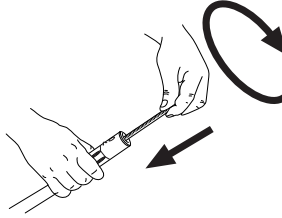

- Mil, rakora doğru şekilde yerleştirildiğinde, milin ucu, rakorun kenarından yaklaşık 10 mm dışarı çıkmış olmalıdır.

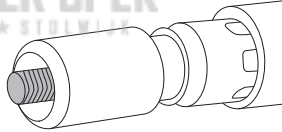

- Delik, kavrama kapağının üstündeki kilitleme düğmesinin doğrudan altına yerleşecek şekilde, hareket mili rakorunu kavrama kapağına takın.

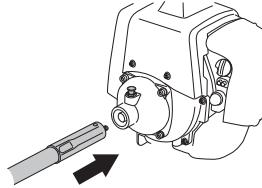

- Mili iterken aynı zamanda döndürerek doğru şekilde geçtiğinden emin olun.

BAKIM

Bakım şeması

Aşağıda makinede yapılması gereken bakım işlemlerinin listesi vardır. Konuların çoğu Bakım bölümünde anlatılmıştır. Kullanıcının, Kullanım Kılavuzu'nun yalnız bu bölümünde belirtilen bakım ve servisi yapması gerekir. Daha kapsamlı işlerin yetkili bir servis tarafından yapılması zorunludur.

Bakım	Günlük bakım	Haftalık bakım	Aylık bakım
Makinenin dış kısmını temizleyin.	X		
Kayışların zarar görmemiş olduğundan emin olunuz.	X		
Gaz tetikleme kilidi ve gaz fonksiyonunun güvenlik açısından doğru şekilde işlediğinden emin olun.	X		
Makinenin tutamağının ve dümeninin tam ve düzenli oturduğundan emin olunuz.	X		
Makinenin durdurma düğmesinin çalışıp çalışmadığını kontrol ediniz.	X		
Kesme cihazının boşa devir yapıp yapmadığını kontrol ediniz.	X		
Hava filtresini temizleyiniz. Gerektiğinde değiştiriniz.	X		
Koruma bölümünün zarar görmemiş olduğundan ve çatlamış veya delinmemiş olduğundan emin olunuz. Koruma bölümünde çatlaklar ve yarıklar meydana gelmişse hemen değiştiriniz.	X		
Kesme cihazının keskin ağzını kontrol ediniz, merkezi yerde bulunduğundan yeterli keskinlikte bulunduğundan ve çatlama veya yarıklar bulunmadığından emin olunuz. Tüm olarak merkezi bir biçimde monte edilmemiş bir kesme aleti titreşimlere ve makinenin bozulmasına yol açabilir.	X		
Kesme başlığının zarar görmemiş olmasından ve çatlak veya yarıklar bulunmadığından emin olunuz. Eğer gerekiyorsa kesme başlığını değiştiriniz.	X		
Kesme donanımının kilit somununun doğru şekilde sıkıldığından emin olun.	X		
Kesme aracının taşıyıcı korumasının tam ve düzenli bir şekilde yerleştirilebildiğini görünüz.	X		
Vidaların ve somunların sıkışma durumlarını denetleyiniz.	X		
Motordan, depodan veya yakıt hatlarından yakıt sızıntısı olup olmadığını kontrol edin.	X		
Motor çalıştırma cihazı (halatıyla beraber) kontrol ediniz.		X	
Titreşim yalıtıcılarının arızalı olup olmadıklarını denetleyiniz.		X	
Bujileri dı ş kı sınıdaki temizliğini yapın. Bujileri sökerek elektrik mesafesini kontrol ediniz. Mesafeyi 0,6-0,7 mm ye ayarlayın ve bujileri değiştiriniz. Bunun için bujiler kılavuzuna bakın ve radyo arızası.		X	
Makinenin soğutma sistemini temizleyin.		X	
Karbüratörü dış kısımda temizleyiniz ve kirlerini boşaltınız.		X	
Dingil açısının 3/4 oranda yağla dolu olduğunu kontrol ediniz. Eğer gerekiyorsa özel yağla doldurunuz.		X	
Susturucuyu temizleyin.			X
Yakıt filtresinde kirlenme olup olmadığını ve yakıt hortumunda çatlak veya başka kusurlar olup olmadığını kontrol edin. Gerekirse değiştirin.			X
Tüm kabloları ve bağlantıları denetleyiniz.			X
Debriyajı, debriyaj yaylarını ve debriyaj kampanasını kontrol ederek, aşınmış olduklarından emin olunuz. Eğer gerekiyorsa değiştiriniz.			X
Bujileri değiştiriniz. Bunun için bujiler kısmına bakınız radyo arızası.			X
Tahrik dingilini Husqvarna tahrik dingili yağıyla yağlayın.		Bunu altı ayda bir yapın.	

TEKNİK BİLGİLER

Teknik bilgiler

	553RBX
Motor	
Silindir hacmi, cm ³	50,6
Silindir çapı, inç/mm	45,5
Hortum uzunluğu, inç/mm	31,1
Boşta çalışma deviri, rpm	2800
Önerilen en yüksek devir, rpm	13000
Hareketli dingillerin r/dakika dönme sayısı	9285
ISO 8893 uyarınca azami motor çıkışı, kW/dev/dak	2,3/9500
Katalizator eksoz	Hayır
Ateşleme sistemi	
Buji	NGK CMR7H
Elektrot aralığı, inç/mm	0,6-0,7
Yakıt yağlama sistemi	
Benzin deposu hacmi, litre	0,8
Ağırlık	
Ağırlık, yakıtsız, kesme cihazı ve koruma, kg	12,1
Gürültü emisyonları	
(1 nolu dipnota bakınız)	
Ses gücü düzeyi, ölçülmüş dB(A)	117
Ses gücü düzeyi, garantili L _{WA} dB(A)	118
Ses düzeyi	
(2 nolu dipnota bakınız)	
Kullanıcının kulağına gelen ses basıncının karşılığı ölçülmüş ve EN ISO 11806 ve ISO 22868, dB(A) olarak uygunluğu tespit edilmiştir.	
Budayıcı başlığıyla (orijinal) donatılmış	97
Çim bıçağıyla (orijinal) donatılmış	97
Titreşim düzeyleri	
(3 nolu dipnota bakınız)	
EN ISO 11806 ve ISO 22867 doğrultusunda, kulplarda ölçülen denk vibrasyon düzeyleri (a _{hν,eq}): m/sn ²	
Budayıcı başlığıyla (orijinal) donatılmış, sol/sağ	2,7/3,3
Çim bıçağıyla (orijinal) donatılmış, sol/sağ	2,7/3,8

Dipnot 1: Çevreye verilen gürültü emisyonu AB direktifi 2000/14/EC uyarınca ses gücü (L_{WA}) olarak ölçülmüştür. Makine için bildirilen ses gücü düzeyi, en yüksek düzeyi veren orijinal kesme ataşmanı ile ölçülmüştür. Garanti edilen ve ölçülen ses gücü arasındaki fark, garantili ses gücünün, 2000/14/AT Sayılı Direktif doğrultusunda, ölçüm sonucundaki dağılımı ve aynı modelden farklı makineler arasındaki değişimleri de içermesidir.

Not 2: Makinenin denk gürültü basınç düzeyi için bildirilen verilerdeki tipik istatistik dağılımı (standart sapma) 1 dB (A) şeklindedir.

Not 3: Denk vibrasyon düzeyi için bildirilen verilerin tipik istatistik dağılımı (standart sapması) 1 m/sn² şeklindedir.

TEKNİK BİLGİLER

Onaylı aksesuarlar	Tip	Kesici aletin koruması, çeşit. no.
Çim biçme makinesi/çim bıçağı	Multi 300-3 (Ø 300 3-diş)	537 33 16-03
	Multi 275-4 (Ø 275 4-diş)	537 33 16-03
Kesme başlığı	T45x (Ø 2,7 - 3,3 mm kordon)	537 33 16-03
	T55x (Ø 2,7 - 3,3 mm kordon)	537 33 16-03
Destek fincanı	Sabit	-

Uygunluk konusunda AB deklarasyonu (Sadece Avrupa için geçerlidir)

Biz, **Husqvarna AB**, SE-561 82 Huskvarna, İsveç, tel: +46-36-146500, seri numaraları 2012' den başlayan ve bunu izleyen (nominal değerler plakasının üzerinde yıl açıkça belirtilmiştir ve bunu seri numarası izler) **Husqvarna 553RBX** kesme testerelerinin KONSEY DİREKTİFİ'ne uygun olduğunu beyan ederiz:

- 17 Mayıs 2006 tarihli, "makinelere ilgili", **2006/42/AT**

- "elektromanyetik uygunluk hakkında" başlıklı, 15 aralık 2004 tarih ve **2004/108/EEC** sayılı KONSEY DİREKTİFİ ve geçerli ekler.

- "çevreye gürültü emisyonları hakkında" başlıklı, 8 Mayıs 2000 tarih ve **2000/14/EC** sayılı KONSEY DİREKTİFİ. Ek V'e göre uygunluk değerlendirmesi. Gürültü emisyonları hakkında bilgi için, Teknik bilgiler başlıklı bölüme bakınız.

Uygulanan standartlar: **EN ISO 12100:2010, CISPR 12:2007, ISO 14865:1998.**

SMP Svensk Maskinprovning AB, Fyrisborgsgatan 3, SE-754 50 Uppsala, İsveç, Husqvarna AB adına gönüllü sınamayı gerçekleştirmiştir.

Sertifikanın numarası: **SEC/12/2344**

Huskvarna, 8 şubat 2012

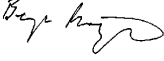

KEES VAN DER SPEK

Bengt Frögelius, Geliştirme müdürü (Husqvarna AB yetkili temsilcisi ve teknik dokümantasyon sorumlusu.)

KAJ POMENIJO SIMBOLI

Simboli

OPOZORILO! Žaga za čiščenje, rezalnik grmovja in trimer so lahko ob napačni uporabi zelo nevarno orodje, ki povzroči resne poškodbe in smrt uporabnika ali tretjih oseb. Zato je zelo pomembno, da natančno preberete in se poglobite v navodila za uporabo.

Natančno preberite navodila za uporabo in se prepričajte, da ste jih razumeli, predno začnete z uporabo stroja.

Pri delu vedno uporabljajte:

- Zaščitna čelada, če obstaja nevarnost padajočih predmetov
- Atestirane zaščitne slušalke
- Atestirana zaščita oči

Maks. število vrtljajev na izhodni osi, rpm

Izdelek je v skladu z veljavnimi CE predpisi.

Nevarnost izmeta in odsunka.

Uporabnik stroja je odgovoren, da so ljudje in živali oddaljeni najmanj 15 m od delovnega mesta.

Stroje z rezili za žaganje ali rezili za travo lahko naglo vrže v stran, ko pridejo v stik s trdnim predmetom. To se imenuje potisk rezila. Rezilo vam lahko odreže roko ali nogo. Ljudje in živali naj bodo najmanj 15 metrov vstran od stroja.

Puščici označujeta mejni točki za namestitev ročaja.

Vžig; Čok: Ročico za čok potegnite v položaj za čok. Izklopno stikalo se bo avtomatično premaknilo v startni položaj.

Črpalka za gorivo.

Vedno uporabljajte atestirane zaščitne rokavice.



Uporabljajte vedno grobe škornje, v katerih ne drsi.



Namenjeno le za nekovinske in gibljive rezilne priključke, to se pravi za glavo trimerja z nitko za trimer.



Emisija hrupa v okolico v skladu z direktivo Evropske skupnosti. Emisija stroja je podana v poglavju Tehnični podatki in na nalepki.



Pazite, da se z deli telesa ne dotaknete vročih površin.



Ostali simboli in oznake na stroju se nanašajo na specifične zahteve za certifikacijo, ki veljajo na nekaterih tržiščih.

Pregled in/ali vzdrževanje stroja je dovoljeno le, če je motor ugasnjen in izklopno stikalo v položaju STOP.



Vedno uporabljajte atestirane zaščitne rokavice.



Stroj je potrebno redno čistiti.



Pregled s prostim očesom.



Vsebina

KAJ POMENIJO SIMBOLI

Simboli 180

VSEBINA

Vsebina 181

Pred vžigom bodite pozorni na naslednje: 181

UVOD

Spoštovani kupec! 182

KAJ JE KAJ?

Kaj je kaj pri žagi za čiščenje? 183

SPLOŠNA NAVODILA ZA VAMOST

Pomembno 184

Osebnostna zaščitna oprema 184

Varnostna oprema stroja 185

Rezila 187

MONTAŽA

Nameščanje prilagodljive pogonske gredi 189

Priključite kabel dušilke in žice stikala za zaustavitev 189

Sestava J-ročaja 189

Pritrditev rezilna in glave za trimmer 190

Nameščanje varovala za prevoz 191

Prilagoditev oprtnika in žage za čiščenje 191

RAVNANJE Z GORIVOM

Varna uporaba goriva 193

Pogonsko gorivo 193

Točenje goriva 194

VŽIG IN IZKLOP

Pregled pred vžigom 195

Vžig in izklop 195

DELOVNA TEHNIKA

Splošna navodila za delo 197

VZDRŽEVANJE

Uplinjač 199

Zračni filter 199

Filter za gorivo 199

Kotni menjalnik 199

Svečka 199

Pogonska os 200

Urn timer vzdrževanja 201

TEHNIČNI PODATKI

Tehnični podatki 202

EU-zagotovilo o ujemanju 203

Pred vžigom bodite pozorni na naslednje:

Natančno preberite navodila za uporabo.



OPOZORILO! Dolgotrajna izpostavljenost hrupu lahko povzroči trajne okvare sluha. Zato vedno nosite odobreno zaščitno opremo za ušesa.



OPOZORILO! Brez predhodnega dovoljenja proizvajalca ne smete nikoli spreminjati prvotne izvedbe stroja. Vedno uporabljajte izključno originalne dele. Spremembe brez pooblastila in/ali neoriginalni deli lahko povzročijo resne poškodbe ali smrt uporabnika in drugih.



OPOZORILO! Žaga za čiščenje, rezalnik grmovja in trimmer so lahko ob napačni uporabi zelo nevarno orodje, ki povzroči resne poškodbe in smrt uporabnika ali tretjih oseb. Zato je zelo pomembno, da natančno preberete in se poglobite v navodila za uporabo.

KEES VAN DER SPEK
STOLWIJK

Spoštovani kupec!

Čestitamo Vam, ker ste izbrali Husqvarna-izdelek! Husqvarna ima zgodovinski izvor že v letu 1689, ko je kralj Karl XI dal postaviti tovarno na bregu reke Huskvarna, kjer so izdelovali muškete. Izbor mesta ob reki Huskvarna je bil logičen, saj je reka ustvarjala vodno silo, kar pomeni, da je dajala vodno energijo. V obdobju več kot 300 let, od kar obstaja tovarna Husqvarna, je bilo izdelano neskončno veliko število različnih izdelkov; vse od štedilnikov na drva do modernih gospodinjstkih strojev, šivalnih strojev, koles, motornih koles itd. Leta 1956 je bila lansirana prva motorna kosilnica, ki ji je leta 1959 sledila prva motorna žaga in na tem področju deluje Husqvarna še danes.

Husqvarna je danes eden od vodilnih svetovnih proizvajalcev izdelkov za delo v gozdu in na vrtu, kakovost in učinkovitost izdelkov pa imajo prvo prioriteto. Tržna ideja je razvoj, izdelava in trženje izdelkov na motorni pogon, namenjenih delu v gozdu in na vrtu ter izdelkov za gradbeno in strojno industrijo. Cilj Husqvarne je tudi, da je vodilna na področju ergonomije, prilagojenosti uporabniku, varnosti in varstvu okolja, zaradi česar smo uvedli dolgo vrsto fines z namenom, da izboljšamo izdelke prav na teh področjih.

Prepričani smo, da boste z zadovoljstvom cenili kakovost in učinkovitost našega izdelka mnogo prihodnjih let. Nakup enega od naših izdelkov vam daje dostop do profesionalne pomoči kar se tiče popravil in servisa, če bi se vseeno kaj pripetilo. Če prodajalna, kjer ste stroj kupili, ni ena od naših pooblaščenih prodajaln, vprašajte, kje je najbližja pooblaščen delavnica.

Upamo, da boste zadovoljni z Vašim strojem in da bo stroj Vaš spremljevalec mnogo prihodnjih let. Pomnite, da so ta navodila za uporabo vrednostni papir. Če boste sledili vsebini navodil (uporaba, servis, vzdrževanje itd.), boste pomembno podaljšali življenjsko dobo stroja, kakor tudi ceno rabljenega stroja. Če boste stroj prodali, poskrbite, da bo novi lastnik dobil pripadajoča navodila za uporabo.

Zahvaljujemo se Vam, da uporabljate Husqvarna izdelek.

Husqvarna AB nenehno razvija in izpopolnjuje svoje izdelke in si zato pridržuje pravico sprememb v, na primer, obliki in izgledu brez predhodnega opozorila.

KEES VAN DER SPEK
TUINMACHINES ★ STOLWIJK

KAJ JE KAJ?

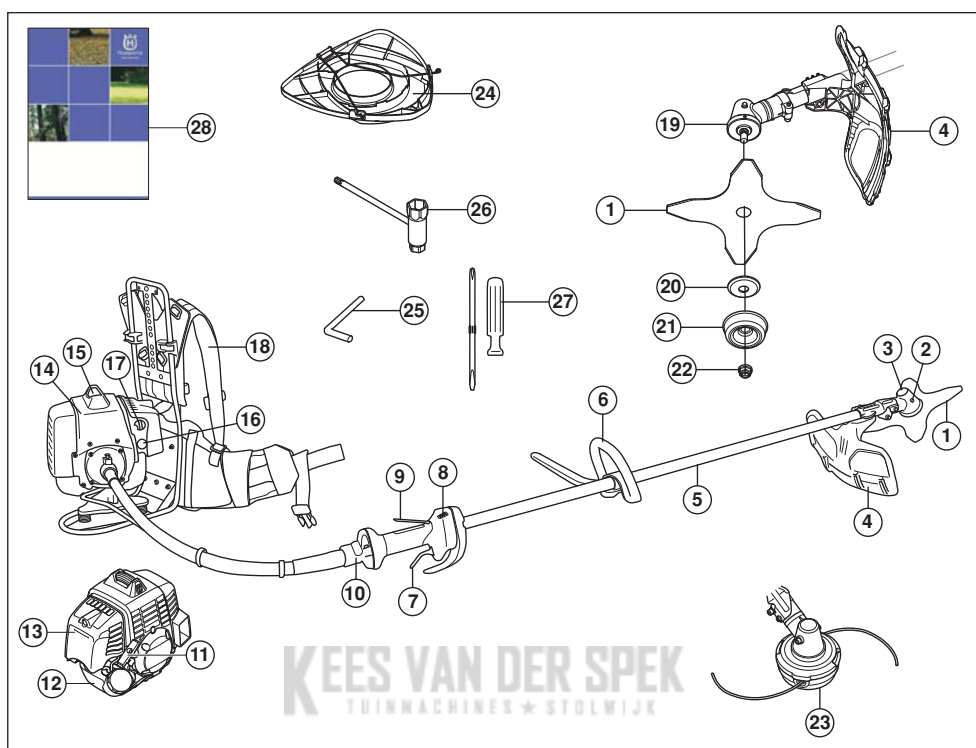

Kaj je kaj pri žagi za čiščenje?

- | | | | |
|----|----------------------------------|----|--------------------------------|
| 1 | Rezilo | 15 | Pokrivalo za svečko in svečka. |
| 2 | Polnjenje maziva, kotni menjalik | 16 | Črpalka za gorivo. |
| 3 | Kotni menjalik | 17 | Uravnavanje čoka |
| 4 | Ščitnik rezilnih priključkov | 18 | Oprtnik |
| 5 | Držalo | 19 | Nosilec |
| 6 | Pentljasti ročaj | 20 | Prirobnica |
| 7 | Uravnavanje plina | 21 | Podporna skodela |
| 8 | Izklopno stikalo | 22 | Matica za pritrnitev |
| 9 | Zapora plina | 23 | Glava trimerja |
| 10 | Sklopka držala | 24 | Ščitnik za prevoz |
| 11 | Startna ročica | 25 | Sponka |
| 12 | Posoda za gorivo | 26 | Ključ za matico rezila |
| 13 | Ohišje zračnega filtra | 27 | Izvijač |
| 14 | Ohišje cilindra | 28 | Navodila za uporabo |

SPLOŠNA NAVODILA ZA VAMOST

Pomembno

POMEMBNO!

Orodje je namenjeno le košenju in prirezovanju trave.

Edini rezilni priključki, ki jih smete uporabljati skupaj z motorjem kot pogonskim sredstvom, so tisti, ki jih priporočamo v poglavju Tehnični podatki.

Stroja ne uporabljajte, če ste utrujeni, če ste pili alkohol ali če jemljete zdravila, ki vplivajo na vid, presojo ali telesno koordinacijo.

Pri delu vedno uporabljajte osebno zaščitno opremo. Glejte navodila v poglavju Oseba zaščitna oprema.

Ne uporabljajte stroja, ki je bil kakorkoli predelan in ni več v skladu z originalno izvedbo.

Ne uporabljajte stroja, ki ne deluje pravilno. Sledite navodilom za pregled, vzdrževanje in servis v skladu z napotki v teh navodilih. Nekatere vrste vzdrževalnih del in popravil lahko opravi samo za to usposobljeno strokovno osebje. Glejte navodila v poglavju Vzdrževanje.

Pred začetkom morajo biti nameščeni vse pokrovi, varovala in ročice. Da bi se izognili nevarnosti električnega udara se prepričajte, da sta pokrov za svečko in zaganjalnik nepoškodovana.

Uporabnik stroja mora poskrbeti, da v premeru 15 metrov od delovnega mesta ni ne ljudi, ne živali. Če več uporabnikov dela na istem delovnem območju, mora biti varnostna razdalja najmanj dvojna dolžina drevja, toda nikoli manj kot 15 metrov.



OPOZORILO! Stroj med delovanjem proizvaja elektromagnetno polje. To polje lahko v nekaterih pogojih interferira z aktivnimi ali pasivnimi medicinskimi vsadki. Da bi zmanjšali nevarnost resne ali smrtne poškodbe, priporočamo, da se osebe z medicinskimi vsadki pred uporabo stroja posvetujejo s svojim zdravnikom in s proizvajalcem vsadka.



OPOZORILO! Delujoči stroj v zaprtem ali slabo prezračevanem prostoru lahko povzroči smrt zaradi zadušitve ali zastrupitve z ogljikovim monoksidom.



OPOZORILO! Nikoli ne dovolite otrokom, da uporabljajo napravo ali, da so v njeni bližini. Ker je naprava opremljena z vmetnim stikalom za izklop jo lahko že z majhno hitrostjo in silo vključite, kar pomeni, da lahko tudi majhni otroci v določenih okoliščinah zaženejo napravo. To lahko pomeni tveganje resne osebne poškodbe. Zaradi tega odstranite pokrivalo za svečko, ko naprave ne morete natančno nadzorovati.

Osebna zaščitna oprema

POMEMBNO!

Žaga za čiščenje, rezalnik grmovja in trimer so lahko ob napačni uporabi zelo nevarno orodje, ki povzroči resne poškodbe in smrt uporabnika ali tretjih oseb. Zato je zelo pomembno, da natančno preberete in se poglobite v navodila za uporabo.

Ob vsaki uporabi stroja uporabljajte vedno atestirano osebno zaščitno opremo. Osebna zaščitna oprema ne izključuje nevarnosti poškodb, vendar pa v primeru nesreče omili posledice. Pri izbiri zaščitne opreme se posvetujte z vašim trgovcem.



OPOZORILO! Bodite vedno pozorni na svarilne znake in klice, kadar uporabljate zaščitne slušalke. Zaščitne slušalke vedno snemite takoj, ko ste ustavili motor.

ZAŠČITNA ČELADA

Zaščitna čelada, če obstaja nevarnost padajočih predmetov



ZAŠČITNE SLUŠALKE

Uporabljajte zaščitne slušalke, ki učinkovito dušijo zvok.



ZAŠČITA OČI

Vedno uporabljajte atestirano zaščito oči. Tudi če uporabljate vezir, morate vedno uporabljati tudi atestirana zaščitna očala. Atestirana očala so tista očala, ki izpolnjujejo standard ANSI Z87.1 za ZDA ali pa EN 166 za dežele EU.



ROKAVICE

Uporabljajte rokavice, kadar je potrebno, na primer pri montiranju rezilnih priključkov.



SPLOŠNA NAVODILA ZA VAMOST

ŠKORNJI

Uporabljajte vedno grobe škornje, v katerih ne drsi.



OBLEKA

Uporabljajte obleko iz odpornega materiala; izogibajte se širokih oblačil, ki se zatikajo v podrast in vejeve. Vedno delajte v trpežnih dolgih hlačah. Ne nosite nakita, kratkih hlač ali sandalov in nikoli ne delajte bosí. Poskrbite, da vam lasje ne padajo preko ramen.

PRVA POMOČ

Pri delu imejte vedno pri sebi pribor za prvo pomoč.



Varnostna oprema stroja

To poglavje opisuje varnostne detajle stroja, način njihovega delovanja ter kako jih pregledujemo in vzdržujemo, tako da bodo v stanju, ki zagotavlja varnost pri delu. V poglavju Kaj je kaj? navajamo, kje so ti detajli na vašem stroju.

Opustitev pravilnega vzdrževanja stroja in nestrokovno servisiranje/popravila lahko skrajšajo življenjsko dobo stroja in povečajo nevarnost nesreč. Dodatne informacije lahko dobite v najbližji servisni delavnici.

POMEMBNO! Servis in popravilo stroja zahtevata posebno strokovno usposobljenost. To velja še zlasti za varnostno opremo stroja. Če pri spodaj opisanem pregledu ugotovite, da katerikoli del stroja ne deluje tako, kot je opisano spodaj, se nemudoma obrnite na pooblaščen servisno delavnico. Pri nakupu vseh naših izdelkov vam jamčimo dostop do strokovnih popravil in servisa. Če stroja niste kupili v kateri od naših pooblaščenih servisnih prodajal, vprašajte prodajalca, kje je najbližja pooblaščen servisna delavnica.



OPOZORILO! Nikoli ne uporabljajte stroja s poškodovano varnostno opremo. Varnostno opremo stroja pregledujte in vzdržujte natančno v skladu z navodili, ki so podana v tem poglavju. Če stroj ob pregledu ne izpolnjuje vseh opisanih pogojev, ga nemudoma prepustite v po

Zapora plina

Zapora plina (A) je konstruirana tako, da preprečuje nehoten vklop uravnavanja plina. Ko stisnemo zaporo (A) k ročaju (=ko držimo za ročaj), sprostimo uravnavanje plina B. Ko izpustimo ročaj, se uravnavanje plina in zapora plina vrmeta v svojo prvotno lego. Njuno gibanje uravnava med seboj neodvisni

povratni vzmeti. Ta sistem zagotavlja, da se uravnavanje plina avtomatično prestavi v prosti tek.

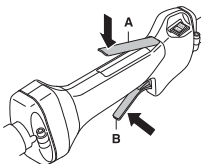

Prepričajte se, da je ročica za uravnavanje plina v prostem teku, kadar je v svojem izhodiščnem položaju.

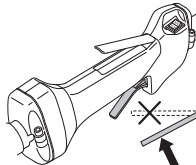

Stisnite zaporo plina in se prepričajte, da se povrne v svoj prvotni položaj, ko jo izpustite.

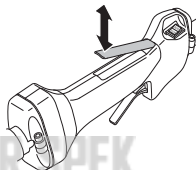

Preverite, če se ročica za plin in zapora plina premikata neovirano in ali njuni povratni vzmeti delujeta pravilno.

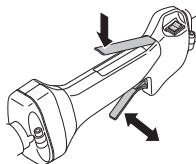

Glej poglavje pod naslovom Vžig. Vžgite stroj in mu dajte polni plin. Izpustite plinsko ročico in se prepričajte, da se rezilni priključek ustavi in obmiruje. Če se rezilni priključek vrtil, ko je plinska ročica v legi prostega teka, preglejte nastavitve uplinjača v prosti legi. Glejte navodila v poglavju Vzdrževanje.

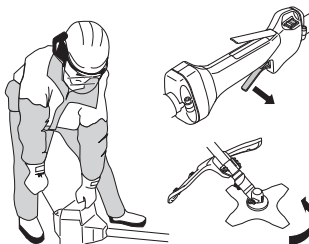

SPLOŠNA NAVODILA ZA VAMOST

Izklopno stikalo

Izklopno stikalo uporabljamo za izklop motorja.

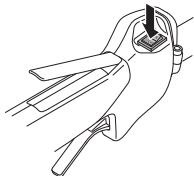

Vžgite motor in preverite, če se ustavi, ko izklopno stikalo potisnete v položaj STOP.

Ščitnik rezilnih priključkov

Ta ščitnik preprečuje metanje različnih predmetov v uporabnika. Istočasno ščitnik preprečuje, da bi se uporabnik neprostovoljno dotaknil rezil.

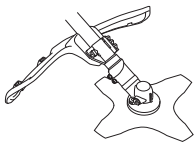

Prepričajte se, da ščitnik ni poškodovan in da nima razpok. Če je bil ščitnik izpostavljen udarcem, ali pa če ima razpoke, ga zamenjajte.

Uporabljajte izključno ščitnik, namenjen prav temu rezilnemu priključku. Glejte poglavje Tehnični podatki.



OPOZORILO! V nobenem primeru ne smete uporabljati rezilnih priključkov, če niste prej montirali atestiranega ščitnika. Glejte poglavje Tehnični podatki. Če uporabite pokvarjen ali napačen ščitnik, lahko povzročite resne osebne poškodbe.

Sistem dušenja tresljajev



Vaš stroj je opremljen s sistemom dušenja vibracij, ki je zasnovan tako, da tresljaje ublaži na najmanjšo možno stopnjo in vam s tem olajša delo.

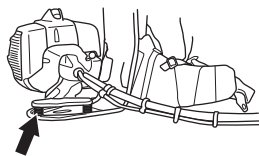

Če uporabite nepravilno navito nitko, ali pa tope oziroma napačne rezilne priključke (napačen tip ali napačno piljen; glejte navodila v poglavju Brušenje rezila), se učinek tresljajev poveča.

Sistem za dušenje vibracij ublaži tresljaje, ki se z motorja in verige prenašajo na ročaja stroja.

Redno preverjajte stanje elementov za dušenje vibracij. Bodite pozorni na morebitne razpoke in druge deformacije. Priporočamo, če so dušilni elementi celi in dobro pritrjeni.



OPOZORILO! Pri ljudeh, ki imajo težave s krvnim obtokom, lahko pretirana izpostavljenost tresljajem povzroči poškodbe ožilja ali živcev. Če opazite znamenja pretirane izpostavljenosti tresljajem, se posvetujte z zdravnikom. Takšna znamenja so: odrenelost udov, izguba občutka za dotik, "ščemenje", "zbadanje", bolečina, oslabelost, ter spremembe v barvi ali na površini kože. Običajno se pojavijo v prstih, na rokah ali na zapestjih. Nevarnost sprememb je večja ob delu pri nizkih temperaturah.

Dušilec

Dušilec je zasnovan tako, da zmanjšuje hrup na najmanjšo možno mero in istočasno odvaja izpušne pline v smeri od uporabnika. Dušilec, opremljen s katalizatorjem, zmanjšuje tudi količino škodljivih snovi v izpušnih plinih.

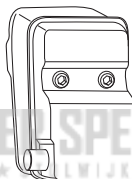

Nikoli ne uporabljajte stroja s pokvarjenim dušilecem.



Redno preverjajte, če je dušilec dobro pritrjen na stroj.

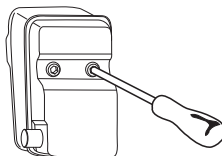

Če je dušilec na vašem stroju opremljen s mrežastim lovilecem isker, morate mrežico redno čistiti. Zamašena mrežica povzroča pregrevanje motorja, kar lahko vodi do resnih okvar motorja.

SPLOŠNA NAVODILA ZA VAMOST



OPOZORILO! Dušilec, opremljen s katalizatorjem, je med uporabo in tudi po njej zelo vroč. To velja tudi, kadar je motor v prostem teku. Ob stiku z njim se lahko opečete. Mislite tudi na nevarnost požarov!



OPOZORILO! Notranjost dušilca vsebuje snovi, ki so lahko rakotvorne. Če je dušilec poškodovan, se izogibajte stiku z njegovimi deli.



OPOZORILO! Mislite na: Izpušni plini so vroči in lahko vsebujejo iskre, ki lahko povzročijo požar. Zato stroja nikoli ne vžigajte v zaprtih prostorih ali v bližini vnetljivih snovi!

Matica za pritrditev

Nekatere rezilne priključke pritrdimo s pomočjo matice za pritrditev.



Pri montaži priključkov zategnite matico v nasprotni smeri rotacije rezilnih priključkov. Pri demontaži rezilnih priključkov zrahljate matico v smeri vrtenja. (POZOR! Matica ima levi navoj.) Matico privijte s ključem.

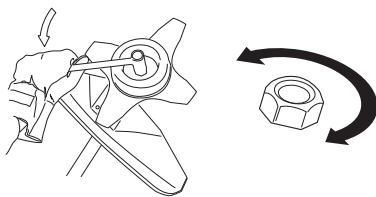

Matični nylonski zatič ne sme biti tako izrabljen, da ga je mogoče odviti s prsti. Navoj mora zdržati najmanj 1,5 Nm. Matico po desetkratni uporabi zamenjajte.

Oprtnik



Preglejte, da je oprtnik nepoškodovan.

V nujnih primerih lahko stroj in pas snamete s sebe na naslednji način.



Rezila

To poglavje obravnava kako s pravilno izbiro in vzdrževanjem rezil dosežete:

- Zmanjšate nevarnost odsunkov.
- Dosežete največjo učinkovitost žaganja.
- Podaljšate življenjsko dobo rezil.

POMEMBNO!

Uporabljajte izključno rezilne priključke skupaj s ščitnikom, ki ga priporočamo! Glejte poglavje Tehnični podatki.

Sledite navodilom, priloženim rezilnim priključkom, za pravilno navijte nitke in izbiro nitkega premera.

Prizadevajte si, da bodo zobje rezila vedno dobro in pravilno brušeni! Sledite našim napotkom. Sledite tudi navodilom na embalaži rezila.



OPOZORILO! Ustavite motor vsakokrat, ko morate rokovati z rezilnim priključkom. Rezilni priključek se namreč vrtil tudi po tem, ko ste izpustili plinsko ročico. Preverite, da se je rezilni priključek popolnoma ustavil in snemite kabel s svečke, predno začnete rokovati z rezilnim priključkom.



OPOZORILO! Napačen rezilni priključek ali napačno brušen žagin list povečuje nevarnost odsunka.

Rezila

Rezilna plošča in nož za travo sta namenjena čiščenju površin z grobo travo.

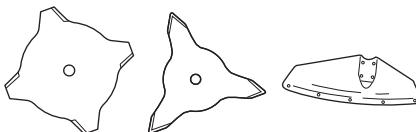

SPLOŠNA NAVODILA ZA VAMOST

Glava trimerja je namenjena za košenje trave.



Splošna pravila



Uporabljajte izključno rezilne priključke skupaj s ščitnikom, ki ga priporočamo! Glejte poglavje Tehnični podatki.

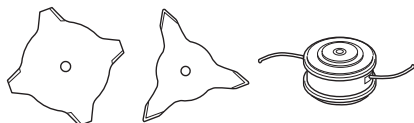

Skrbite, da bodo zobje rezila dobro in pravilno brušeni! Sledite našim navodilom in uporabljajte priporočeno šablono za piljenje. Napačno piljenje ali poškodovano rezilo veča nevarnost nesreč.

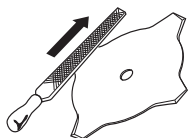

Redno preverjajte, če imajo rezilni priključki poškodbe ali razpoke. Poškodovan rezilni priključek morate vedno zamenjati.

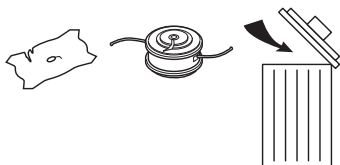

Brušenje noža za travo in rezilne plošče



- Preberite navodilo na embalaži rezilnega priključka. Rezilo in nož brusimo z navadno ploščato pilo.

- Vse ostrine pilite enakomerno, zato da obdržite uravnoteženost.

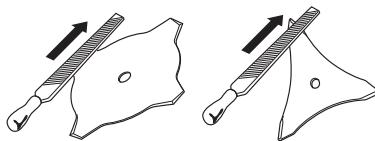

OPOZORILO! Vedno zavržite rezilo, ki je zvito, upognjeno, počeno, nalomljeno ali drugače poškodovano. Nikoli ne poskušajte naravnati ukrivljenega rezila. Vedno uporabljajte le originalne rezilne priključke predpisanega tipa.

Glava trimerja

POMEMBNO!

Poskrbite, da je nitka za trimer enakomerno in trdno navita okoli tuljave, sicer nastajajo zdravju škodljivi treslaji v stroju.

- Uporabljajte samo tiste glave za trimer in tiste nitke, ki jih priporočamo. Proizvajalec je preizkusil nitke tako, da se le-te najbolje ujemajo z močjo motorja. Skladnost z močjo motorja je še posebno pomembna, kadar uporabljate popolnoma avtomatično glavo trimerja. Uporabljajte samo priporočene rezilne priključke. Glejte poglavje Tehnični podatki.
- 
- Na splošno zahtevajo manjši stroji manjše glave trimerja in obratno. Kadar uporabljamo nitko, mora namreč motor iztiskati nitko radialno iz glave trimerja in istočasno uporabljati lastno moč proti uporu trave, ki jo kosimo.
 - Tudi dolžina nitke je pomembna. Dolga nitka zahteva večjo moč motorja kot kratka, četudi imata isti premer.
 - Poskrbite, da je nož, ki je vgrajen na ščitnik trimerja v dobrem stanju. Naloga tega noža je, da reže nitko na pravilno dolžino.
 - Če želite podaljšati življenjsko dobo nitke, jo lahko za nekaj dni namočite v vodo. Nitka bo trdnjša in njena življenjska doba daljša.

MONTAŽA

Nomeščanje prilagodljive pogonske gredi



- Odvijte dva vijaka pri spojki gredi.

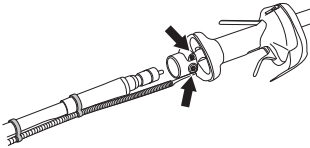

- Prilagodljivo gred potisnite skozi zanke kablov in jo namestite v spojko gredi. Preverite, ali je gred pravilno vstavljena, tako da jo obrnete in potisnete hkrati.
- Privijte dva vijaka.
- Tulec pogonske gredi namestite v pokrov sklopke tako, da je luknja postavljena neposredno pod zapornim gumbom na pokrovu sklopke.

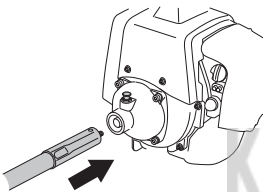

- Preverite, ali je gred pravilno vstavljena, tako da jo obrnete in potisnete hkrati.
- Blokirni zatič se mora vrniti v prvotni položaj, tako da se tulec pogonske gredi ne more sneti s sklopke.

Priključite kabel dušilke in žice stikala za zaustavitev



- Žico za dovod plina iz sistema kablov (A) in iz motorja (B) vstavite v plastični tulec, kot je prikazano.

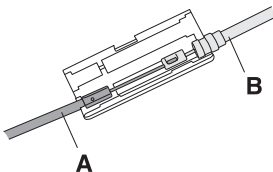

- Zaprite plastični tulec.

- Vključite žice za zaustavljno stikalo v pripadajoče priključke iz motorja. Upoštevajte, da polariteta žic ni pomembna.

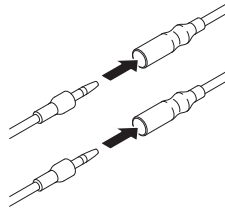

Sestava J-ročaja



- Položite ročaj na držalo. Bodite pozorni na to, da morate ročaj montirati na držalo na mesto pod oznako s puščico.

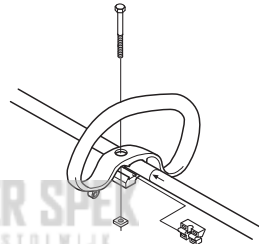

- Potisnite distančno ploščico v zarezo na pentljastem ročaju.
- Namestite vijak in matico. Vijaka ne pričvrstite preveč.
- J-ročaj vstavite v pentljasti ročaj s tremi vijaki tako, kot je prikazano na risbi.

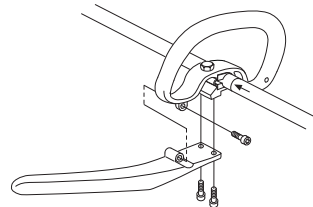

MONTAŽA

- Fino nastavite ročaj, tako da bo delovni položaj pri delu s trimerjem udoben. Trdno zategnite vijak/navojno ročico.

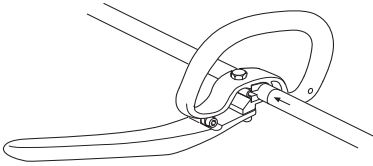

OPOZORILO! Kadar vstavite J-ročaj, smete uporabljati le rezilno ploščo/nož za travo ali glavo trimerja/plastične nože. Skupaj z J-ročajem ne smete nikoli uporabljati žaginega lista.

Pritrnitev rezilna in glave za trimer



OPOZORILO! Ko vstavljate rezilne priključke, je zelo pomembno, da sta nosilec/prirobnica vstavljena natančno v središče rezilnega priključka. Napačno vstavljen rezilni priključek lahko povzroči resno in/ali celo smrtno varno poškodbo.

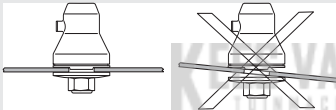

OPOZORILO! V nobenem primeru ne smete uporabljati rezilnih priključkov, če niste prej montirali atestiranega ščitnika. Glejte poglavje Tehnični podatki. Če uporabite pokvarjen ali napačen ščitnik, lahko povzročite resne osebne poškodbe.

POMEMBNO! Žaginega lista ali rezilne plošče ne smete uporabljati brez predpisanega vodila, ščitnika in oprtnika.

Namestitev zaščitnega podaljška.



POZOR! Zaščitni podaljšek je treba zmeraj namestiti pri uporabi glave obrezovalnika/plastičnih rezil in kombiniranega ščitnika. Zaščitni podaljšek je treba zmeraj odstraniti pri uporabi rezila za travo in kombiniranega ščitnika.

Ščitnik rezila/kombinirani ščitnik (A) nataknete na mesto pritrditve na držalu in ga privijte z vijakom.

Vstavite vodilo zaščitnega podaljška v režo kombiniranega ščitnika. Nato pritrдите zaščitni podaljšek v položaj na ščitniku s štirimi zaponkami za hitro pritrnitev.

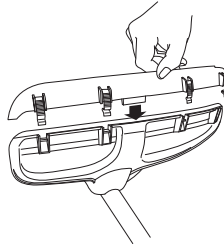

Nastavek ščitnika se enostavno odstrani s pomočjo izvijača, kot kaže slika.

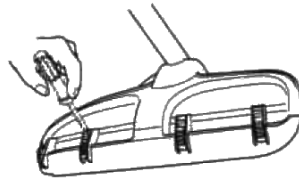

Kako priključimo ščitnik, rezilno ploščo in nož



- Ščitnik rezila/kombinirani ščitnik (A) nataknete na mesto pritrditve na držalu in ga privijte z vijakom (L). Uporabljajte ščitnik rezila, ki ga priporočamo. Glejte poglavje Tehnični podatki. **POZOR!** Poskrbite, da je odstranjen zaščitni podaljšek.

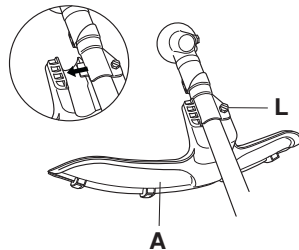

- Vstavite nosilec (B) na izhodno gred.
- Zavrte os rezila tako, da se bo ena od lukenj pokrivala z ustrezno luknjo v ohišju menjalnika.
- Vstavite sponko (C) v luknjo, tako da bo os vpeta.
- Vstavite rezilo (D), oporno skodelo (E) in oporno ploščo (F) na izhodno gred.
- Privijte matico (G). Matico morate priviti z momentom 35–50 Nm (3,5 – 5 kpm). Uporabite ključ, ki je v priboru. Ključ držite čim bližje ščitniku rezila. Matica se zateza, ko

MONTAŽA

ključ obračate v nasprotni smeri vrtenja (POZOR! levi navoj).

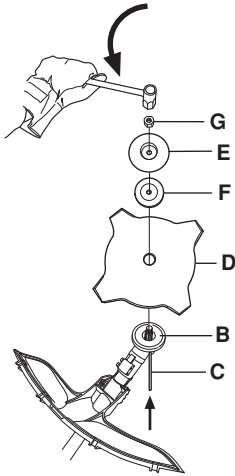

Montaža ščitnika trimerja in glave trimerja



- Montirajte ščitnik trimerja (A), namenjen za delo z glavo trimerja. POZOR! Poskrbite, da je nameščen zaščitni podaljšek.

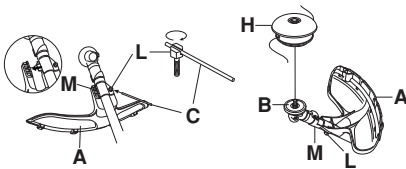

- Trimerjev ščitnik/kombinirani ščitnik nataknete na mesto pritrditve na držalu in ga privijte z vijakom (L).
- Vstavite nosilec (B) na izhodno gred.
- Zavrtite os rezila tako, da se bo ena od lukenj pokrivala z ustrezno luknjo v ohišju menjalnika.
- Vstavite sponko (C) v luknjo, tako da bo os vpeta.
- Navijte glavo trimerja/plastične nože (H) v nasprotni smeri vrtenja.

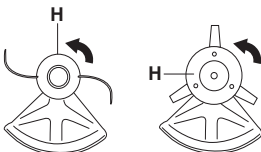

- Demontiranje poteka po obratnem postopku.

Nameščanje varovala za prevoz



- Vstavite rezilo v transportni ščitnik (A).
- Za pritrnitev transportnega ščitnika vpiňte obe pritrtilni sponki (B) v zrezji (C).

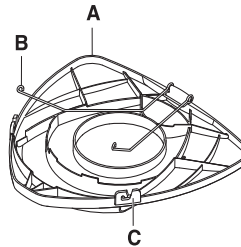

Prilagoditev oprtnika in žage za čiščenje



Nastavitev višine osnovne plošče

- Odvijte obe sponki, ki držita osnovno ploščo.

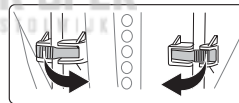

- Na eni strani sprostite osnovno ploščo z okvirja.

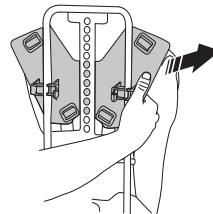

MONTAŽA

- Osnovno ploščo premaknite na želeno višino in jo pritrdite. Preverite, ali se zatič ujema z luknjami na okvirju; pri tem glejte sliko.

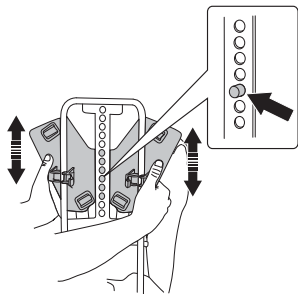

Prilagoditev oprtnika

- Namestite pas.
- Pas zategnite tako, da se čvrsto prilega.



- Zategnite čezprсни pas.



- Po potrebi vertikalno prilagodite čezprсни pas in preverite, ali se dobro prilega.

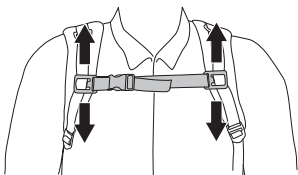

- Nastavite naramnice tako, da se obremenitev enakomerno razporedi čez ramena.



- Odvijte ali zategnite pas, tako da je pas obremenjen s pribl. 70 % in ramena s 30 % obremenitve.

KEES VAN DER SPEK
TUINMACHINES * STOLWIJK

Varna uporaba goriva

Nikoli ne vžigajte stroja:

- 1 Gorivo ste polili po orodju. Obrišite žago in počakajte, da ostanki goriva izhlapijo.
- 2 Če ste gorivo polili po sebi ali po vaši obleki, se preoblecite. Umijte tiste telesne dele, ki so bili v stiku z gorivom. Uporabljajte milo in vodo.
- 3 Če gorivo uhaja. Redno preverjajte tesnost pokrova posode za gorivo in dovode goriva.

Prevoz in shranjevanje

- Pri prevozu in shranjevanju stroja in goriva se prepričajte, da morebitno puščanje goriva oziroma hlapi ne morejo priti v stik z iskro ali odprtim ognjem, na primer z iskrami, ki jih povzročajo električni stroji, elektromotorji, električna stikala/vtičnice ali peči za centralno kurjavo.
- Za shranjevanje in prevoz goriva uporabljajte le posebne, za ta namen prilagojene in atestirane posode.
- Če nameravate stroj shraniti za dalj časa, posodo za gorivo izpraznite. Vprašajte na najbližji bencinski črpalki, kaj storiti z gorivom.
- Preden stroj shranite za dalj časa, ga obvezno očistite in dajte na popoln servis.
- Transportni ščitnik rezilnega priključka mora biti vedno montiran, ko stroj prevažate ali shranite.
- Med transportom napravo zavarujte.



OPOZORILO! Bodite previdni, kadar rokujete z gorivom. Mislite na nevarnost požara, eksplozije in poškodb pri vdihu.

Pogonsko gorivo

POZOR! Motorno žago poganja dvotaktni motor, zato je potrebno kot gorivo vedno uporabljati mešanico bencina in olja za dvotaktne motorje. Pomembno je, da vedno natančno izmerite količino olja, saj le tako dobite pravilno mešanico. Pri mešanju majhnih količin goriva lahko že majhna netočnost bistveno vpliva na kvaliteto mešanice.



OPOZORILO! Gorivo in hlapi goriva so izredno lahko gorljivi in lahko povzročijo resne poškodbe, če jih vdihamo, ali pa pridejo v stik s kožo. Pri rokovanju z gorivom bodite zato vedno zelo previdni in skrbite za dobro prezračevanje.

Bencin



POZOR! Zmeraj uporabite kakovostno mešanico bencina z najmanj 90 oktanov (RON). Če ima vaš stroj katalizator (glej poglavje Tehnični podatki), morate za mešanico uporabiti kakovosten neosvinčen bencin. Osvinčen bencin uniči katalizator.

Če je na voljo okolju prilagojen bencin, tako imenovani alkyl bencin, uporabljajte to vrsto bencina.

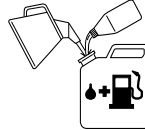

- Najnižja priporočljiva kakovost goriva je 90 oktanov (RON). Če motor poganja gorivo, ki ima manj kot 90 oktanov lahko pride do tako imenovanega udarjanja. S tem se poveča temperatura motorja in ga lahko resno poškoduje.
- Če pogosto delate pri visokih obratih, priporočamo bencin z višjo oktansko vrednostjo.

Olje za dvotaktne motorje

- Za najboljše rezultate in učinek uporabljajte HUSQVARNA olje za dvotaktne motorje, ki je posebej narejeno za naše zračno hlajene, dvotaktne motorje.
- Nikoli ne uporabljajte dvotaktnega olja, ki je namenjeno za zunajkrmne motorje, hlajene z vodo, ki jim tudi pravijo zunajkrmno olje (imenovano TCW).
- Nikoli ne uporabljajte olja za štiritaktne motorje.
- Slaba kakovost olja ali prebogata mešanica olja/benzina lahko ogrozi delovanje katalizatorja in zmanjša njegovo življenjsko dobo.
- Mešalno razmerje
1:50 (2%) z HUSQVARNA dvotaktnim oljem.
1:33 (3%) z olji, narejenimi za zračno hlajenje, dvotaktni motorji, klasificirani za JASO FB/ISO EGB.

Bencin, l	Olje za dvotaktne motorje, l	
	2% (1:50)	3% (1:33)
5	0,10	0,15
10	0,20	0,30
15	0,30	0,45
20	0,40	0,60

RAVNANJE Z GORIVOM

Mešanje

- Mešanico bencina in olja vedno pripravljajte v čisti posodi, atestirani za gorivo.
- Vedno začnite tako, da v posodo najprej natočite polovico potrebne količine bencina. Nato dodajte celotno količino olja. Dobro premešajte (s tresenjem). Dodajte preostalo količino bencina.
- Predno vlijete mešanico v posodo za gorivo, jo (s tresenjem) temeljito premešajte.

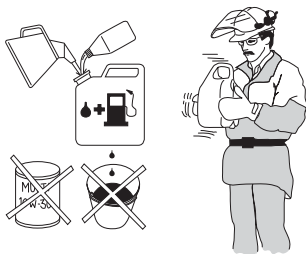

- Pripravite samo toliko mešanice, kolikor jo porabite v enem mesecu.
- Če stroja dalj časa ne boste uporabljali, izpraznite posodo za gorivo in jo očistite.



OPOZORILO! Dušilec katalizatorja je med uporabo in tudi po njej zelo vroč. To velja tudi, kadar je motor v prostem teku. Zavedajte se nevarnosti požara, še posebej, če delate v bližini lahko vnetljivih materialov in/ali hlapov.

Točenje goriva



OPOZORILO! Naslednji varnostni ukrepi zmanjšujejo nevarnosti požara:

Pri rokovanju z gorivom ne kadite in ne imejte v bližini vročih predmetov.

Nikoli ne točite goriva, če je motor vžgan.

Ugasnite motor in ga pustite nekaj minut hladiti, predno začnete z natakanjem.

Pokrovček posode za gorivo odvijte počasi, kajti v posodi je lahko nadpritisek.

Po končanem točenju goriva pokrovček trdno privijte.

Pred vžigom stroj vedno umaknite s kraja, na katerem ste ga polnili z gorivom, in proč od vira goriva.

- Uporabljajte posodo za gorivo, zaščiten proti prenapolnjenosti.
- Obrišite okolico posode za gorivo. Umazanija v posodi za gorivo povzroča motnje v delovanju.
- Poskrbite, da je gorivo temeljito premešano, predno ga natočite v posodo za gorivo.



Min 3 m
(10 ft)



VŽIG IN IZKLOP

Pregled pred vžigom



- Nikoli ne uporabljajte stroja brez ščitnika ali s ščitnikom, ki je poškodovan.
- Vsa ohišja morajo biti pravilno montirana in brez napak, predno začnete uporabljati stroj.
- Natančno pregledjte rezilo, tako da na korenu zob ali okoli središčne luknje ni razpok. Najpogostejši vzrok za nastanek razpok je pojav ostrih robov na korenih zob, ki so posledica piljenja ali pa uporaba slabo brušenega rezila. Rezilo zavržite.

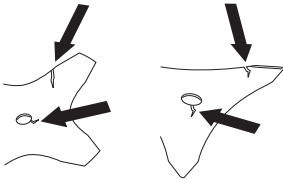

- Pregledjte, če so na prirobnici razpoke, ki so posledica utrujenosti materiala ali pa pretrdega zategovanja. Prirobnico z razpokami zavržite.

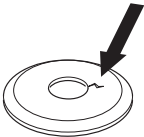

- Prepričajte se, da je matica mogoče trdno zategniti. Matica mora biti zategnjena z najmanj 1,5 Nm. Matico zategnite z momentom zategnitve 35–50 Nm.



- Pregledjte, če je ščitnik rezila nepoškodovan in brez razpok. Menjajte ščitnik rezila, ki je bil izpostavljen udarcem in ki ima razpoke.

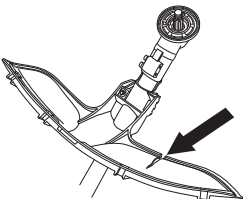

- Prepričajte se, da sta glava trimmerja iz trimmerjev ščitnik nepoškodovana in brez razpok. Menjajte glavo trimmerja in

trimmerjev ščitnik, če sta bila izpostavljena udarcem ali če imata razpoke.

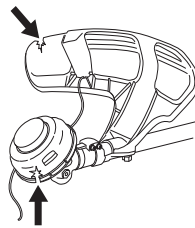

Vžig in izklop



OPOZORILO! Pred vžigom morata biti vodilo in ohišje menjalnika sestavljena, kajti v nasprotnem primeru lahko menjalnik odpade in povzroči telesne poškodbe.

Pred vžigom stroj vedno umaknite s kraja, na katerem ste ga polnili z gorivom, in proč od vira goriva. Stroj postavite na trdno podlago. Poskrbite, da rezilni priključek ni v stiku s kakšnim drugim predmetom.

Prepričajte se, da na delovnem območju ni tretjih oseb, ki bi jih stroj lahko poškodoval. Varnostna razdalja je 15 metrov.

Vžig



Vžig: Prestavite stop ročico v položaj start.

Črpalka za gorivo: Večkrat pritisnite na gumijasti gumb črpalke, tako da se gumb začne polniti z gorivom. Ni potrebno, da je gumb popolnoma poln.

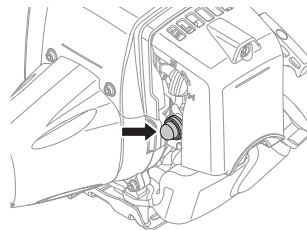

VŽIG IN IZKLOP

Čok: Ročico čoka premaknite v položaj za čok.

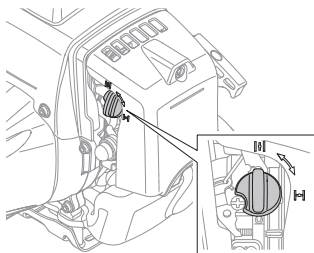

OPOZORILO! Če vžgete motor s pomočjo čoka v položaju čok ali vžig, se začne rezilni priključek nemudoma vrteti.

Telo stroja pritisnite k zemlji z levo roko (POZOR! Ne z nogo!). Primite vžigalno ročico in z desno roko vlečite vžigalno vrstico počasi tako dolgo, da začutite odpor (vžig začne "prijemati"), potem pa potegnite hitro in močno. **Vžigalne vrvice nikoli ne navijajte okoli zapetja.**

Ko motor vžge, čok takoj izključite, ali pa ponavljate postopek tako dolgo, da motor vžge. Ko motor vžge, mu takoj dajte polni plin, tako da se bo startni plin avtomatično izklopil.

POZOR! Vžigalne vrvice nikoli ne izvlecite do konca in tudi vžigalno ročico nikoli ne potisnite v skrajno lego. Takšno ravnanje lahko poškoduje stroj.

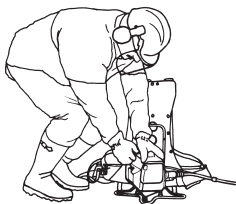

POZOR! V označeno področje ne polagajte nobenega dela telesa. Dotik lahko povzroči opekline na koži ali električni udar, če je pokrov svečke poškodovan. Zmeraj uporabljajte rokavice. Ne uporabljajte stroja pri katerem je pokrov svečke poškodovan.

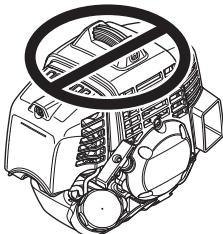

Izklop



Motor ustavite z izklopnim stikalom.

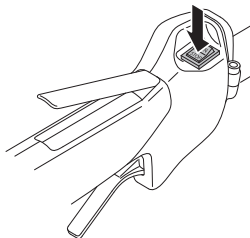

KEES VAN DER SPEK
TUINMACHINES * STOLWIJK

Splošna navodila za delo

POMEMBNO!

To poglavje obravnava splošna pravila za varno delo z žago za čiščenje in trimermem.

Če se vam zgodi, da dvomite, če je nadaljnja uporaba še primerna, se posvetujte s strokovnjakom. Povprašajte vašega trgovca ali servisno delavnico.

Izogibajte se uporabi, če se ne počutite dovolj usposobljeni.

Predno začnete orodje uporabljati, morate razumeti razliko med čiščenjem gozda, košenjem in obrezovanjem trave.

Osnovna varnostna pravila



- Oglejte si okolico in se prepričajte:
 - Da v bližini ni ljudi, živali ali predmetov, ki bi lahko vplivali na vašo kontrolo stroja pri delu.
 - Varnostni ukrepi, da ljudje, živali in drugo ne more priti v stik z rezilnimi priključki ali pa s predmeti, ki jih rezilni priključek po naključju izvrže.
 - POZOR!** Nikoli ne uporabljajte stroja, če v primeru nesreče ne morete priklicati pomoči.
- Preverite delovno območje. Odstranite vse trde delce, kot so delci kamna, črepinje, žebelji, jeklena žica, vrvi in podobno, ki jih rezalnik lahko zaluča ali navije.
- Ne uporabljajte žage v slabih vremenskih razmerah. Takšne razmere so gosta megla, močen dež ali veter, hud mraz, itd. Delo v slabem vremenu utruja bolj kot sicer, obenem pa je povezano z dodatnimi nevarnostmi, kot so poledica, nepredvidljiva smer padca dreves, ipd.
- Poskrbite, da lahko na območju dela varno stojite in hodite. Če morate nepričakovano spremeniti delovni položaj, če posebej pazite na morebitne ovire (korenine, kamenje, veje, jarke, itd). Pri delu na nagnjenih tleh bodite še posebej previdni.



- Med obratovanjem vedno nosite nahrbtni pihalnik oprtan čez ramena.
- Držite dobro ravnotežje in gotovo oporišče.
- Napravo zmeraj držite z obema rokama.
- Rezalnika ne dvigujte v višino pasu.
- Kadarkoli menjate delovni okoliš, mora biti motor ugasnjen. Če je razdalja večja, uporabljajte vedno ščitnik za prevoz.

- Nikoli ne odložite stroja s prižganim motorjem, če ga ne morete nadzorovati.



OPOZORILO! Uporabnik stroja ali tretja oseba ne smeta nikoli poskušati odstraniti razrezan material, če je motor v pogonu ali pa če rezilnik rotira, kajti takšno ravnanje lahko povzroči resne poškodbe.

Ustavite motor in rezilni pribor, preden odstranite material, ki se je ovil okoli osi rezilnika, sicer obstaja nevarnost poškodb. Med in nekaj časa po uporabi je kotna prestava vroča. Obstaja nevarnost, da se opečete, če se je dotaknete.



OPOZORILO! Pozor pred izmetom predmetov. Uporabljajte vedno atestirana zaščitna očala. Nikoli se ne nagibajte čez ščitnik rezilnega priključka. Kamenje, odpadke ipd. lahko stroj vrže v oči, to pa lahko povzroči slepoto ali pa resne poškodbe.

Preprečite dostop na delovno območje nepoklicanim. Otroci, živali, mimoidoči in tisti, ki vam pomagajo pri delu, morajo biti vedno oddaljeni najmanj 15 m. Takoj ustavite stroj, da se vam kdo približuje. Nikoli ne obrnite stroja, če se niste najprej prepričali, da tudi za vami ni nikogar v nevarnem območju.

Osnovna tehnika ko šenja in či ščenja podrasti

Po vsakem delovnem momentu naj motor nekaj časa deluje v prostem teku. Če motor dalj časa deluje pri najvišjih obratih brez obremenitve, se lahko resno poškoduje.



OPOZORILO! Včasih se med rezilni priključek in ščitnik zataknejo veje ali trava. Vedno ugasnite motor, predno začnete s čiščenjem.



OPOZORILO! Stroje z rezili za žaganje ali rezili za travo lahko naglo vrže v stran, ko pridejo v stik s trdnim predmetom. To se imenuje potisk rezila. Potisk rezila je lahko tako močan, da premakne stroj in/ali uporabnika v katerokoli smer ter zaradi tega izgubi nadzor nad strojem. Potisk rezila se lahko zgodi nenapovedano, če se stroj zaplete, ustavi ali ovije. Večja verjetnost za potisk rezila je na področjih, kjer je težko videti material, ki ga režete.

Izogibajte se uporabi rezila na površini med 12 in 3 uro. Hitrost vrtenja rezila lahko prav v tem položaju povzroči nevaren odsunek, še posebno, če žagamo debelejša stebela.

Košenje z rezilno ploščo



- Rezilne plošče in noža za travo ne smete uporabljati, če je rastlinje olesenelo.
- Za vse vrste visoke in goste trave uporabljajte rezilno ploščo.
- Travo kosimo z zamahi z leve na desno, pri čemer je zamah z desne na levo delovni zamah, zamah z leve na desno pa povratni. Rezilna plošča naj kosi z levo stranjo (med 8 in 12 uro).

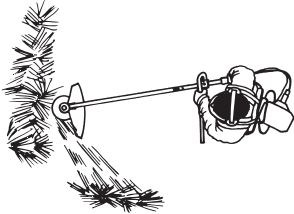

- Če pri košnji nagnete rezilo nekoliko na levo, pada pokošena trava v vrsto, kar pomembno olajša grabljenje.
- Prizadevajte si, da delate ritmično. Stojte trdno in razkoračeni. Pri povratnem zamahu stopite naprej in nato stojte trdno.
- Podpornik rezila naj se rahlo dotika zemlje. Podpornik rezila preprečuje, da bi rezilo udarjalo v zemljo.
- Izogibajte se navijanju zelenja okoli rezila, zato upoštevajte dve pravili:
1 Delajte vedno s polnim plinom.
2 Izogibajte se stiku s pravkar pokošenim zelenjem pri povratnem zamahu.
- Vedno ugasnite motor, snemite oprtnik in položite stroj na tla, predno začnete grabiti.

Košenje trave z glavo trimerja



Čiščenje obronkov

- Držite glavo trimerja malenkost nad zemljo in pod kotom. Zavedajte se, da delo opravlja konec nitke. Dovolite ji, da dela sama. Nikoli je ne potiskajte s silo v material, ki ga čistite.

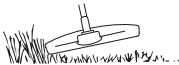

- Nitka učinkovito odstranjuje travo in plevel v bližini zidov, ograj, drevja in nasadov, vendar pa lahko tudi poškoduje občutljivo skorjo na drevju in grmičevju, ali ograjo.
- Nevarnost poškodb na rastlinju zmanjšate, če dolžino nitke skrajšate na 10–12 cm in znižate število vrtljajev motorja.

Popolno odstranjevanje zelenja

- S pomočjo te tehnike zelenje popolnoma odstranimo. Glavo trimerja držite pod kotom in le malo nad zemljo. Nitka naj udarja po zemlji okoli drevja, stolpov, kipov, itd. **POZOR!** Pri tej tehniki se nitka hitreje troši.



- Nitka se troši hitreje, iztiskanje iz glave pa je potrebno pogostejše, če pri delu udarja ob kamenje, opeko, beton, kovinske ograje ipd., kot pa če udarja ob les.
- Pri čiščenju obronkov in popolnem odstranjevanju zelenja, ne uporabljajte polnega plina, zato da bo poraba nitke in izraba glave trimerja manjša.

Košenje

- Trimer je idealen za košenje trave na mestih, ki jih težko kosite z navadno kosilnico. Pri košenju morate držati glavo trimerja vzporedno z zemljo. Izogibajte se neposrednemu stiku glave s podlago, kajti na ta način lahko poškodujete travo ali pa orodje.

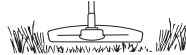

- Pri normalnem košenju se izogibajte neposrednemu stiku glave trimerja z zemljo. Pri stalnem stiku glave trimerja z zemljo lahko pride do poškodb in nepotrebne izrabe glave.

Pometanje

- Ventilacijski tok, ki ga povzroča vrtenje nitke, lahko uporabimo za hitro in enostavno čiščenje. Držite nitko vzporedno s površino, ki jo želite pomesti in zamahujte naprej in nazaj.

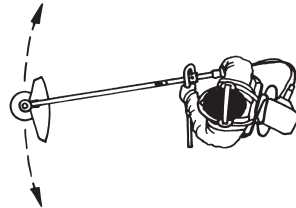

- Kadar kosite in pometate, delajte s polnim plinom, da bo rezultat dela najboljši.

Uplinjač

Nastavljanje hitrosti prostega teka (T)

Preverite, če je zračni filter čist. Ko je hitrost prostega teka pravilna, se rezalna oprema ne bi smela vrteti. Če je nastavev potrebna, zaprite (in v smeri urinega kazalca) obrnite vijak za nastavev prostega teka T ko motor dela dokler se rezalna oprema ne začne vrteti. Odprite (in v nasprotni smeri urinega kazalca) obrnite vijak, dokler se rezalna oprema ne ustavi. Hitrost prostega teka je nastavljena pravilno, ko motor teče v vseh položajih, in obstaja jasna meja med hitrostjo pri kateri se rezalna oprema začne obračati.

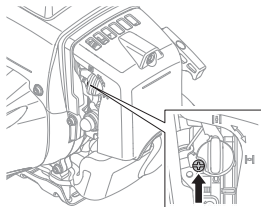

OPOZORILO! Če števila vrtljajev v prostem teku ne morete nastaviti tako, da se rezilni priključek ustavi, se obrnite na vašega trgovca / servisno delavnico. Stroja ne uporabljajte, dokler ni pravilno nastavljen in napaka odpravljena.

Zračni filter



Zračni filter je potrebno redno čistiti, kajti z odstranjevanjem prahu in umazanije preprečimo:

- Motnje v delovanju uplinjača
- Težave pri vžigu
- Pojemanje moči motorja
- Nepotrebno obrabo delov motorja
- Nenormalno visoko porabo goriva.

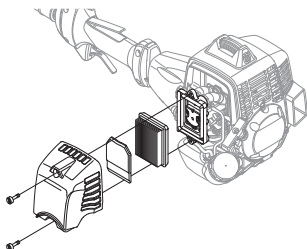

Filter očistite po 25 urah uporabe ali pogosteje, če delate v okolju, kjer se zelo praši.

Čiščenje zračnega filtra

Razstavite ohišje filtra in odstranite filter. Operite ga v topli milnici. Prepričajte se, da je filter suh, predno ga ponovno montirate.

Zračnega filtra, ki ste ga uporabljali dalj časa, ni mogoče dobro očistiti. Zaradi tega je potrebno filter redno nadomeščati z novim. **Če je zračni filter poškodovan, ga nemudoma zamenjajte.**

Filter za gorivo

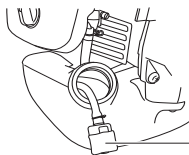

1 Filter za gorivo

Če motor deluje s premajhim dotokom goriva, preverite ali nista blokirana pokrovček in filter za gorivo.

Kotni menjalnik



Kotni menjalnik že v tovarni napolnimo s primerno količino maziva. Vseeno pred začetkom uporabe priporočamo, da pregledate, če je menjalnik napolnjen z mazivom do 3/4. Uporabljajte posebno HUSQVARNA mazivo.

Maziva v ohišju praviloma ni potrebno menjati, razen ob morebitnih popravilih.

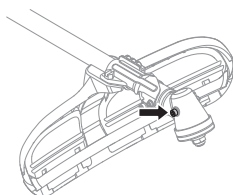

Svečka



Na stanje svečke vpliva naslednje:

- Nepravilna nastavev uplinjača.
- Nepravilna mešanica goriva z oljem (preveč olja ali napačno olje).
- Umazan zračni filter.

VZDRŽEVANJE

Posledica teh dejavnikov je nabiranje oblog na elektrodah svečke, kar lahko privede do nepravilnega delovanja motorja in težav pri vžigu.

Če je moč motorja oslabiljena, če ga je težko vžgati, delovanje v prostem teku pa je neenakomerno: vedno najprej preglejte svečko. Če je zamašena, jo očistite in preverite, da je razmik med elektrodama 0,6–0,7 mm. Svečko zamenjajte po približno enomesečni uporabi, če pa je potrebno, tudi prej.

0,6 - 0,7 mm

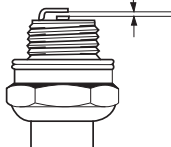

POZOR! Vedno uporabljajte samo tip svečke, ki ga priporočamo! Uporaba napačne svečke lahko uniči bat in valj. Poskrbite, da ima svečka t.i. zaščito proti radijskim motnjam.

Pogonska os



Gibljiva krmilna os je namazana z mazivom za krmilno os podjetja Husqvarna. Os morate namazati vsakih 6 mesecev.

- Dvignite zaporni gumb, ki pridrži tulec pogonske gredi v pokrovu sklopke.

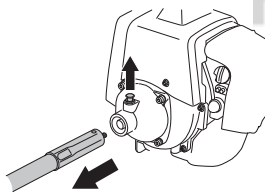

- Tulec pogonske gredi izvlecite iz pokrova sklopke.
- Odstranite pogonsko gred iz tulca, z tresenjem ali povlekom s pomočjo klešč.

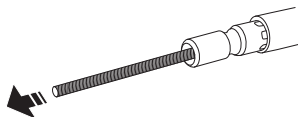

- Nanesite mazivo iz tube po celotni osi. Razmažite s krtačo ali krpo.

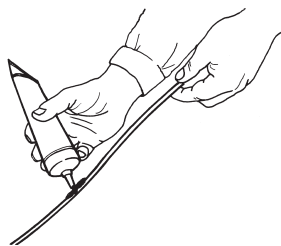

- Potisnite pogonsko gred nazaj v tulec. Preverite, ali je gred pravilno vstavljena, tako da jo obrnete in potisnete hkrati.

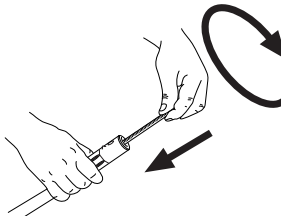

- Ko je gred pravilno vstavljena v tulec, mora konec gredi segati približno 10 mm od roba tulca.

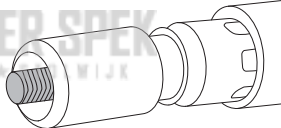

- Tulec pogonske gredi namestite v pokrov sklopke tako, da je luknja postavljena neposredno pod zapornim gumbom na pokrovu sklopke.

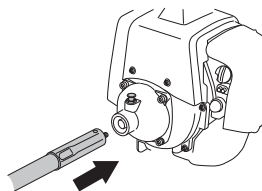

- Preverite, ali je gred pravilno vstavljena, tako da jo obrnete in potisnete hkrati.

VZDRŽEVANJE

Urnik vzdrževanja

V nadaljevanju sledi lista o tem, kako je stroj potrebno vzdrževati. Večina točk je navedena v poglavju Vzdrževanje. Uporabnik sme sam izvajati le tista vzdrževalna in servisna dela, ki so navedena v teh navodilih za uporabo. Zahtevnejše posege mora opraviti pooblaščen servisna delavnica.

Vzdrževanje	Vsakodnevno vzdrževanje	Tedensko vzdrževanje	Mesečno vzdrževanje
Očistite zunanje dele stroja.	X		
Preglejte, da je oprtnik nepoškodovan.	X		
Preglejte, da zapora plina in uravnavanje plina delujeta varno.	X		
Preverite, ali sta ročaj in vodilo nepoškodovana in pravilno pritrjena.	X		
Preglejte, če stop stikalo deluje.	X		
Prepričajte se, da se rezilni priključek ne vrti, kadar je motor v prostem teku.	X		
Očistite zračni filter. Po potrebi ga zamenjajte.	X		
Prepričajte se, da ščitnik ni poškodovan in da nima razpok. Če je bil ščitnik izpostavljen udarcem, ali pa če ima razpoke, ga zamenjajte.	X		
Preglejte, če je rezilo dobro usrediščeno, ostro in da na njem ni razpok. Neusrediščeno rezilo povzroča tresljaje, ki lahko poškodujejo stroj.	X		
Prepričajte se, da glava trimerja ni poškodovana in da nima razpok. Zamenjajte jo, če je potrebno.	X		
Preglejte, da je matica za pritrnitev rezilnega priključka pravilno zategnjena.	X		
Preglejte, če je ščitnik rezila za prevoz nepoškodovan in da ga je mogoče temeljito pritrčiti.	X		
Kontrolirajte, če so vse matice in vijaki temeljito priviti.	X		
Prepričajte se, gorivo ne izteka iz motorja, posode za gorivo ali cevke za gorivo.	X		
Preglejte zaganjalnik s pripadajočo vrstico.		X	
Prepričajte se, da elementi za dušenje treslajev niso poškodovani.		X	
Očistite zunanost svečke. Demontirajte jo in preglejte razdaljo med elektrodama. Nastavite razdaljo na 0,6–0,7 mm ali pa zamenjajte svečko. Poskrbite, da ima svečka t.i. zaščito proti radijskim motnjam.		X	
Očistite hladilni sistem stroja.		X	
Očistite zunanost uplinjača in neposredno okolico.		X	
Preglejte, če je kotni menjalnik do 3/4 napolnjen z mazivom. Specialno mazivo dodajte po potrebi.		X	
Očistite glušnik.			X
Preglejte, da filter za gorivo ni umazan in da cev za dovod goriva nima razpok ali kakšnih drugih poškodb. Dele po potrebi zamenjajte.			X
Preglejte vse kable in priključke.			X
Preglejte, če so sklopka, sklopine vzmeti in sklopkin boben morebiti izrabljeni. Dele po potrebi zamenjajte pri pooblaščenem servisu.			X
Zamenjajte svečko. Poskrbite, da ima svečka t.i. zaščito proti radijskim motnjam.			X
Krmilno os namažite z mazivom za krmilno os podjetja Husqvarna.	To opravite vsakih šest mesecev.		

TEHNIČNI PODATKI

Tehnični podatki

553RBX

Motor

Gibna prostornina valja, cm ³	50,6
Razmik valjev, mm	45,5
Takt, mm	31,1
Prosti tek, rpm	2800
Priporočena maks. stalna hitrost mirovanja, rpm	13000
Vrtljaji na izstopni osi v/min	9285
Maks. izhodna moč motorja po ISO 8893, kW/ v/min	2,3/9500
Dušilec s katalizatorjem	Ne

Sistem vžiga

Svečka	NGK CMR7H
Odprtina elektrode, mm	0,6-0,7

Sistem za gorivo in mazanje

Kapaciteta rezervoarja za gorivo, litri	0,8
---	-----

Teža

Teža, brez goriva, rezilnih priključkov in ščitnika, kg	12,1
---	------

Emisije hrupa

(glej opombo 1)

Moč hrupa, izmerjena dB(A)	117
Moč hrupa, zagotovljena L _{WA} dB(A)	118

Jakost hrupa

(glejte op. 2)

Ekvivalenca pritiska zvoka na uporabnikovo uho, merjena po EN ISO 11806 in ISO 22868, dB(A):

Opremljeno s kosilno glavo (originalno)	97
Opremljeno z nožem za travo (originalnim)	97

Jakost vibracij

(glejte op. 3)

Ekvivalenca nivoja vibracij ($a_{hv,eq}$) v ročajih, izmerjena v skladu z EN ISO 11806 in ISO 22867, m/s².

Opremljeno s kosilno glavo (originalno), levo/desno	2,7/3,3
Opremljeno z nožem za travo (originalnim), levo/desno	2,7/3,8

Op. 1: Emisija hrupa v okolico merjena kot zvočni efekt (L_{WA}) v skladu z ES direktivo 2000/14/ES. Sporočena raven zvočne moči za napravo je izmerjena z originalnim rezalnim priključkom, s katerim se doseže najvišji nivo. Razlika med zajamčeno in izmerjeno ravno zvočne moči je, da zajamčena raven zvočne moči v skladu z Direktivo 2000/14/ES vključuje tudi razpršitev rezultata meritve in razlike med različnimi napravami istega modela.

Opomba 2: Sporočeni podatki za ekvivalenco nivoja zvočnega tlaka za napravo imajo tipično statistično razpršitev (standardni odklon) v vrednosti 1 dB (A).

Opomba 3: Sporočeni podatki za ekvivalenco nivoja vibracij imajo tipično statistično razpršitev (standardni odklon) v vrednosti 1 m/s².

TEHNIČNI PODATKI

Atestirani priključki	Tip	Zaščita za rezilne priključke, št. art.
Rezilna ploščica/nož za travo	Multi 300-3 (Ø 300 3-zobje)	537 33 16-03
	Multi 275-4 (Ø 275 4-zobje)	537 33 16-03
Glava trimerja	T45x (nitka Ø 2,7-3,3 mm)	537 33 16-03
	T55x (nitka Ø 2,7-3,3 mm)	537 33 16-03
Podporna skodela	Pritrjena	-

ES-Izjava o skladnosti (Velja le za Evropo)

Husqvarna AB, SE-561 82 Huskvarna, Švedska, tel +46-36-146500, s tem potrdilom zagotavlja, da so žage za čiščenje **Husqvarna 553RBX** s serijskimi številkami iz leta 2012 in kasneje (leto izdelave, ki mu sledi serijska številka, je podano v besedilu na ploščici s tipsko oznako) v skladu s predpisi, podanimi v DIREKTIVAH SVETA:

- z dne 17. maja 2006, ki se nanaša na stroje, 2006/42/ES

- z dne 15. decembra 2004 "za elektromagnetsko skladnost" **2004/108/ES**.

- z dne 8. maja 2000 "za emisijo hrupa v okolico" **2000/14/ES**. Ocena skladnosti glede na aneks V. Za informacije v zvezi z emisijo hrupa glejte poglavje Tehnični podatki.

Uporabljeni so bili naslednji standardi: **EN ISO 12100:2010, CISPR 12:2007, ISO 14865:1998**.

SMP Svensk Maskinprovning AB, Fyrisborgsgatan 3, SE-754 50 Uppsala, Švedska, je za Husqvarna AB opravil prostovoljno tipsko kontrolo.

Certifikat ima naslednjo številko: **SEC/12/2344**

Huskvarna, 8. februarja 2012

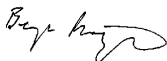

KEES VAN DER SPEK
TUINMACHINES * STOLWIJK

Bengt Frögelius, šef razvoja (Pooblaščen predstavnik za Husqvarna AB in odgovorni za tehnično dokumentacijo.)

T45, T45x

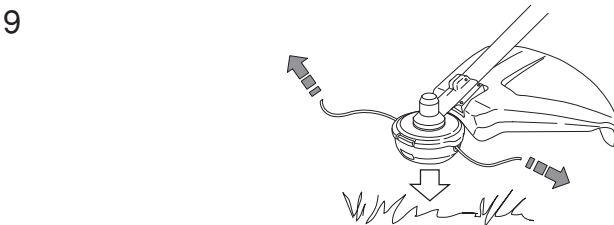
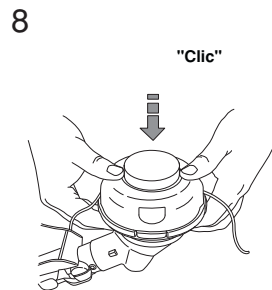
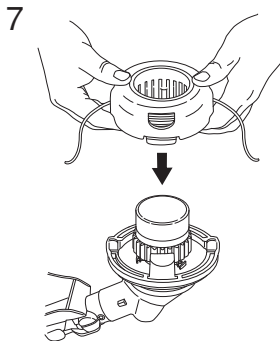
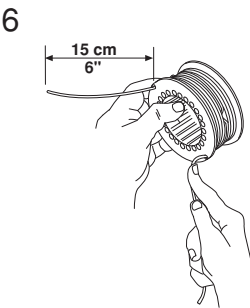
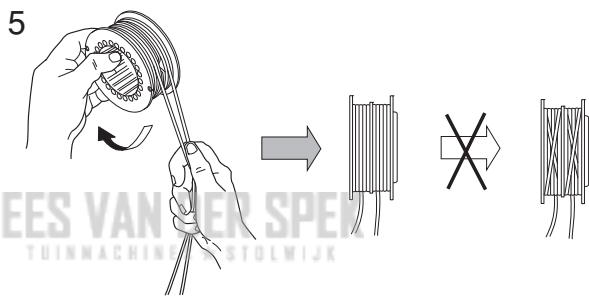
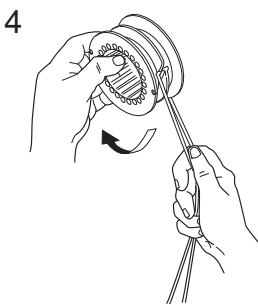
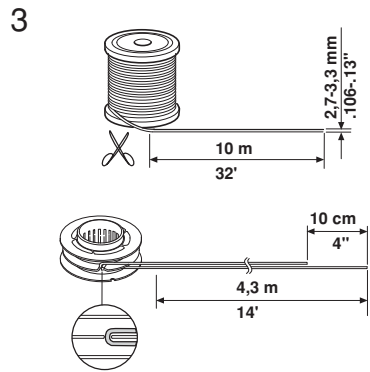
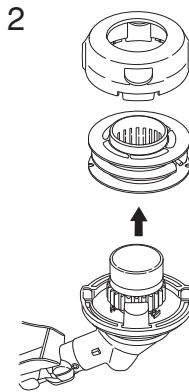
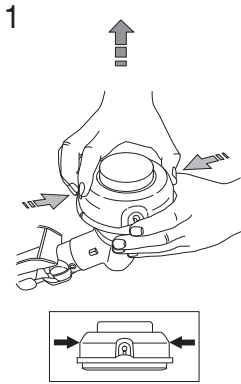

T55x



1

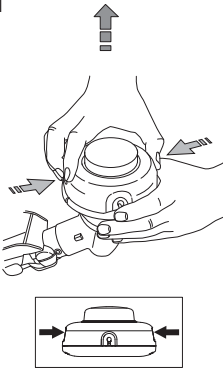

2

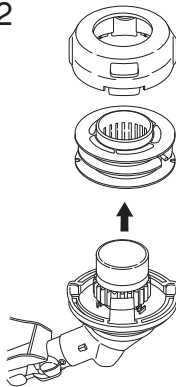

3

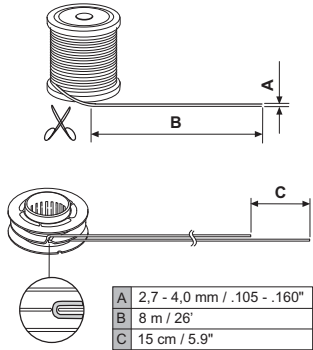

4

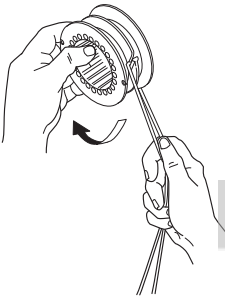

5

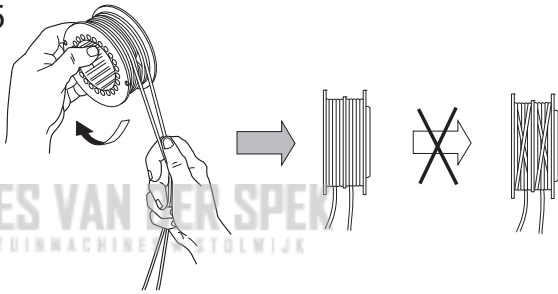

6

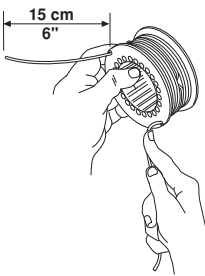

7

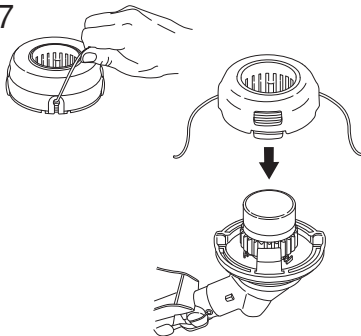

8

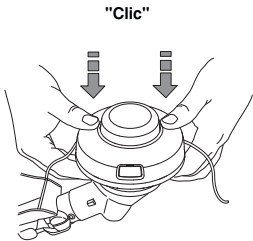

9

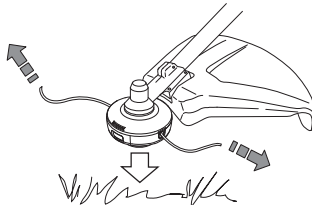

KEES VAN DER SPEK
TUINMACHINES ★ STOLWIJK



www.husqvarna.com

**Original instructions
Instructions d'origine
Istruzioni originali
Originalanweisungen**

**Instruções originais
Instrucciones originales
Orijinal talimatlar
Izvirna navodila**

1154778-38



2012-02-16