

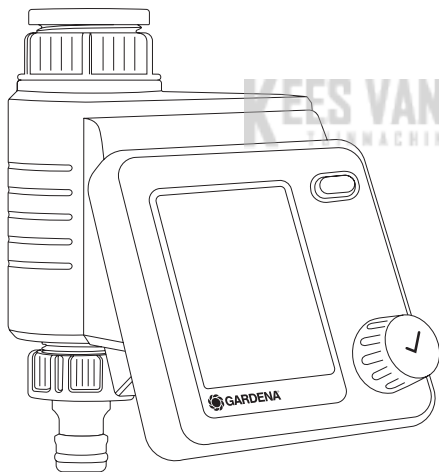

Master Art. 1892



DE Betriebsanleitung

Bewässerungssteuerung

EN Operator's manual

Water Control

FR Mode d'emploi

Programmation d'arrosage

NL Gebruiksaanwijzing

Besproeiingsbesturing

IT Istruzioni per l'uso

Unità di controllo per irrigazione

ES Instrucciones de empleo

Control de riego

PT Manual de instruções

Controlador de rega

EL Οδηγίες χρήσης

Σύστημα ελέγχου ποτίσματος

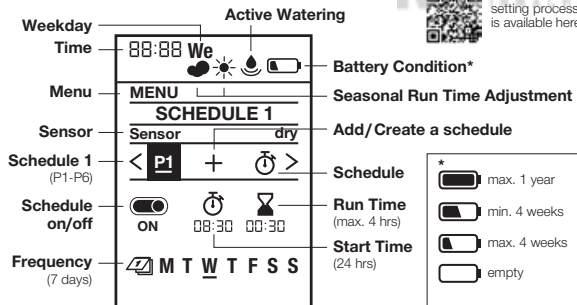
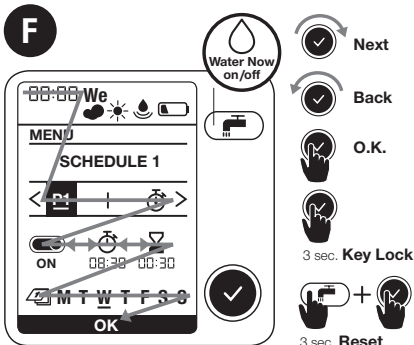
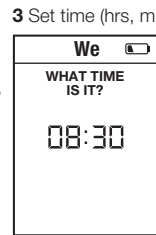
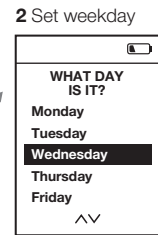
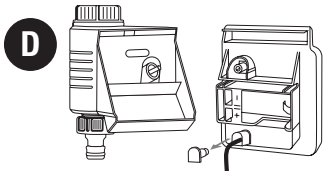
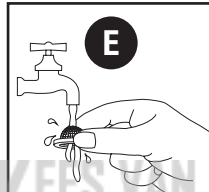
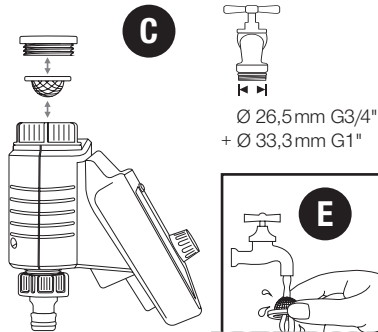
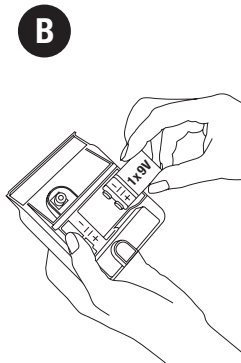
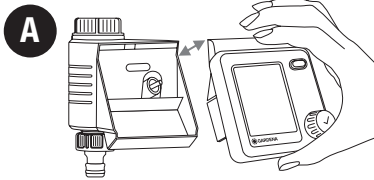

A video of the setting processes is available here:

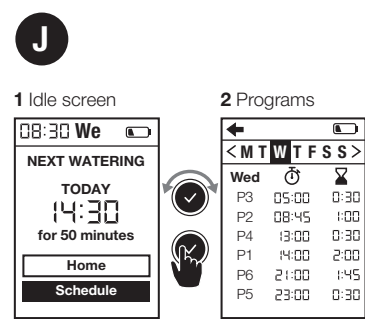
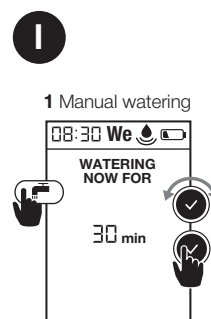

K

- 1 Menu: Seasonal Run Time 2 Regular Run Time 3 Reduce Watering

**L**

- 1 Menu: Rain pause 2 Pause / 3 days

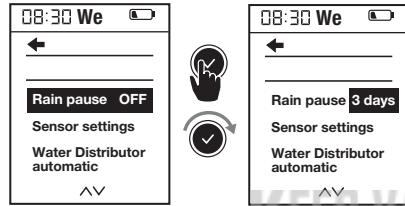
**O****+**

Art. 1197

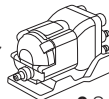

- 1 Menu: Water Distributor automatic 2 Select amount of active water lines 3 Create schedule 1-6 4 Sensor per line (optional) 5 Schedule L1

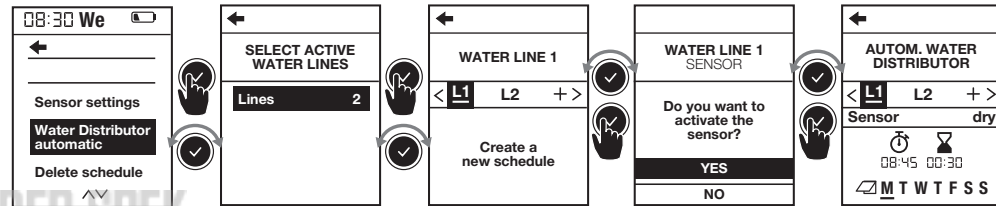
**M**

- 1 Menu: Delete schedule 2 Delete schedule 1

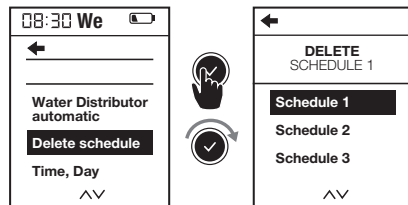
**N****+**

Art. 1188



- 1 Menu: Soil Moisture Sensor 2 Sensor settings

**P**

- 1 Menu: Time, Day 2 Set Time, Day

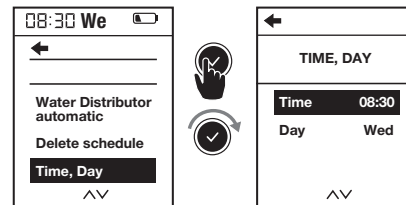
**Q**

- 1 Menu: Language preference 2 Select Language preference



GARDENA Water Control Master

Translation of the original instructions.



For safety reasons, children and young people under 16 as well as anyone who is not familiar with these operating instructions should not use the product. Persons with reduced physical or mental abilities may use the product only if they are supervised or instructed by a responsible person. Children must be supervised to ensure that they do not play with the product. Never operate the product when you are tired, ill or under the influence of alcohol, drugs or medicine.

Intended use:

The GARDENA Water Control is intended for private use in domestic and hobby gardens, exclusively for outdoor use, to control sprinklers and watering systems. The Water Control can be used for automatic watering during holidays.

DANGER! The GARDENA Water Control must not be used for industrial purposes or in conjunction with chemicals, foodstuffs, easily flammable and explosive materials.

1. SAFETY

Important!

Read the operator's manual carefully before use and keep for future reference.

Battery:

To ensure the Water Control runs safely, only a 9V alkaline manganese battery (alkaline) type IEC 6LR61 must be used!

In order to stop the Water Control from failing because of a weak battery if you are away for a long time, the battery must be replaced when the battery symbol flashes.

Setting up:

The Water Control may only be set up vertically with the sleeve nut to the top to prevent water penetrating into the battery compartment.

The minimum water output to ensure that the Water Control functions correctly is 20 – 30 l/h. For example, at least 10 x 2-litre Drip Heads are required to control the Micro-Drip-System.

At high temperatures (over 70 °C at the display) the LCD display may extinguish. This does not affect the program in any way. When the computer cools down the LCD display illuminates again.

The max. temperature for the water flow is 40 °C.

Avoid tensile strain.

→ Do not pull the hose connected to the Water Control.



CAUTION! If the control section is removed when the valve is open, the valve remains open until the control section is reattached.



DANGER! Cardiac arrest! This product makes an electromagnetic field while it operates. This field may under some conditions interfere with active or passive medical implants. To decrease the risk of conditions that can possibly injure or kill, we recommend persons with medical implants to speak with their physician and the medical implant manufacturer before you operate the product.



DANGER! Risk of suffocation! Small parts can be easily swallowed. There is also a risk that the polybag can suffocate toddlers. Keep toddlers away when you assemble the product.

2. INITIAL OPERATION → (Fig. A–D)

A video of the setting processes is available here:



3. FUNCTION → (Fig. F)

The Master Water Control offers two options for watering your garden automatically on a timer:

- **Water 1 area of a garden with a water line**
e.g. using a sprinkler, the GARDENA Micro-Drip-System or the GARDENA Sprinklersystem
- or –
- **Operate 2 – 6 water lines one after another using the GARDENA Automatic Water Distributor, Art. 1197, see Fig. O (optionally available).** Each line can be activated up to once a day.

You can change the settings or move to the next setting by turning the knob. You can confirm the

respective input by pressing the rotary knob. Pressing the knob for longer than 3 seconds locks or unlocks the display. If no more changes are made to the settings, the LCD display switches off after 5 minutes to save energy. To reactivate the display, actuate the rotary knob. The default display appears.

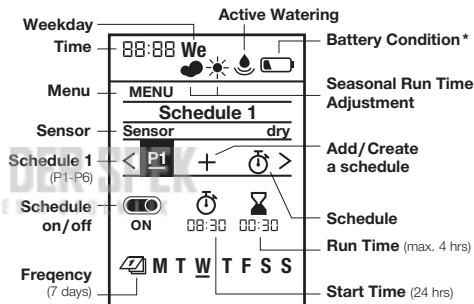

- * max. 1 year max. 4 weeks
 min. 4 weeks empty

4. SETTINGS → (Fig. G–Q)

Initial settings → (Fig. G):

- 1 Set language | 2 Set weekday | 3 Set time (hrs, min.) |
- 4 Ready for schedule

Active (manual) watering → (Fig. I):

1 Manual watering

Setting schedules → (Fig. H):

1 Set schedule | 2 Schedule 1

Configure and save up to 6 different watering schedules by setting the start time, duration and weekdays for each one. Schedules can be activated or deactivated by pressing on/off (see fig. H).

Default display → (Fig. J):

1 Idle screen | 2 Programs

Seasonal watering duration → (Fig. K):

1 Menu: Seasonal Run Time | 2 Regular Run Time |

3 Reduce Watering

You can reduce the durations set for all schedules at once in 10% increments, from 100% down to 10%. This saves you having to change each of the 6 schedules individually.

Tip: Less watering is required in the spring and autumn than in the height of summer. Simply set the maximum watering duration for high summer as the default. Then reduce the watering duration for all schedules at once in convenient 10% increments when there is less need for watering.

Note: When you change the percentage, the duration is adjusted within the schedules and the

“cloud” symbol appears. If the duration is not altered (= 100%), the “sun” symbol is displayed.

Rain pause → (Fig. L):

1 Menu: Rain pause | 2 Pause / 3 days

Pauses all watering operations without changing the set schedules. You can select any number of days between 1 and 9. At the end of the pause, all schedules are reactivated.

Deleting a schedule → (Fig. M):

1 Menu: Delete schedule | 2 Delete schedule 1



Soil Moisture Sensor, Art. 1188

(optionally available) → (Fig. D and N):

1 Menu: Soil Moisture Sensor

Once the soil is sufficiently moist, a watering operation is interrupted or a schedule is disabled so that it cannot be activated. This does not affect active (manual) watering.

→ (Fig. D and N): 1 Connect soil moisture sensor
After a soil moisture sensor is connected, the “sensor activated/deactivated” display will appear – this can take up to 1 minute. Select an option to activate/deactivate the sensor response. Use the switching point controller on the soil moisture sensor to set the level of soil moisture that must be achieved before the sensor responds (see Operator’s Manual for GARDENA Soil moisture sensor).

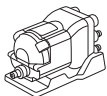

GARDENA Automatic Water Distributor, Art. 1197 (optionally available)

→ (Fig. O): 1 Menu: Water Distributor automatic

This menu allows you to control up to 6 water lines with the Automatic Water Distributor. This includes a necessary minimum pause of 5 minutes between the outlets and a minimum watering duration of 30 seconds (display: 1 min). This time ensures reliable switch-over to the next outlet and makes sure that the schedules and outlets are correctly linked (for details of the commissioning process, see the Operating Instructions for the Water Distributor).

2 Select amount of active water lines

You can select any number between 2 and 6. Seal any outlets on the Water Distributor that you do not need with end caps and move the setting lever to the "OFF" position.

3 Create schedules 1 – 6:

When prompted to do so, enter watering schedules L1 – L6 on the display. For this, use the standard method for entering schedules based on the start time, duration and frequency.

Note: Schedules are not allowed to overlap. If you enter a schedule that overlaps with the next one, the start time of the next watering operation will be postponed and a pause of 5 minutes will be inserted between the operations.

- Start times: Define the start times for the water lines in chronological order. This makes it easier to calculate and suggest the next possible start time.
 - Duration: The total watering duration for all outlets – including the necessary pauses – must not exceed 24 hours.
 - Frequency: Different weekdays can be selected. Note: To ensure correct switch-over and correct linking of the schedules and outlets, any outlets that are not scheduled to operate on a particular day will still be activated for a period of 30 seconds on the day concerned.
 - Reduction in the number of outlets: If the number of outlets is reduced, the superfluous channels will be deleted. For example, if the number of outlets is reduced from 5 to 3, the settings for no. 4 and no. 5 will be deleted.
 - Active (manual) watering: To activate a watering operation manually, press . Please note that a minimum duration of 30 seconds and a pause of at least 5 minutes must be observed.
- ### **4** Sensor per line (optional)
- If a soil moisture sensor is connected, you have the option of activating/deactivating it for each individual outlet. If the sensor is deactivated for a particular schedule, watering will always take place based on the schedule.

If the sensor signals that the level of moisture is sufficient, any pending watering operation will be reduced to a duration of 30 seconds (display: 1 min).

5 Schedule L1

Time → (Fig. P):

1 Menu: Time, day | 2 Set time, day

Language → (Fig. Q):

1 Menu: Language preference | 2 Select language

5. MAINTENANCE → (Fig. E)

6. STORAGE

KEES VAN DER SPEK
TUINMACHINES ★ STOLWIJK



To put into storage:

- The product must be stored away from children.
- To preserve the battery, it should be removed (fig. B).
- Store the controller and the valve unit in a dry, enclosed and frost-free place.



Disposal: (in accordance with RL2012/19/EC)

The product must not be disposed of to normal household waste. It must be disposed of in line with local environmental regulations.

IMPORTANT!

Dispose of the product through or via your municipal recycling collection centre.

Disposal of the battery:

→ Please return a flat battery to a GARDENA dealer or dispose of it properly at your nearest recycling centre.

Dispose of the battery only when discharged.

7. TROUBLESHOOTING

Problem	Possible Cause	Remedy
No display appears	Sleep mode is activated 5 minutes after the last entry is made to save energy.	→ To reactivate the display, press any function button.
	Battery is inserted incorrectly.	→ Check the polarity markings match (+/-).
	Battery is flat.	→ Insert a new (alkaline) battery.
	Temperature on the display is higher than 70 °C.	→ Display appears after the temperature has dropped.
Manual watering is not possible using the  button	Low battery is continuously displayed.	→ Insert a new (alkaline) battery.
	Tap is turned off.	→ Turn the tap on.
	Controller is not connected.	→ Mount the controller on housing.
	Minimum pressure of 0.5 bar not available.	→ Ensure a pressure of at least 0.5 bar and run the program again.
Watering program is not being undertaken (no watering)	Program entry/modification during or just before the start pulse.	→ Make program entry/modification outside the programmed start times.
	Valve was opened manually previously.	→ Avoid possible program overlaps.
	Tap is turned off.	→ Turn the tap on.
	Soil moisture or rain sensor registers damp.	→ If dry, check the setting/location of the soil moisture/rain sensor.
	Controller is not connected.	→ Mount the controller on housing.

Problem	Possible Cause	Remedy
Watering program is not being undertaken (no watering)	Low battery is continuously displayed.	→ Insert a new (alkaline) battery.
	Minimum pressure of 0.5 bar not available.	→ Ensure a pressure of at least 0.5 bar.
Water Control does not close	Minimum quantity of water drawn is less than 20 l/h.	→ Connect more drip heads.
	Valve soiled.	→ Flush in the opposite direction to the normal flow direction.



NOTE: For any other malfunctions please contact the GARDENA service department. Repairs must only be done by GARDENA service departments or specialist dealers approved by GARDENA.

KEES VAN DER SPEK
TUINMACHINES ★ STOLWIJK

8. TECHNICAL DATA

Water Control	Value /Unit	Water Control	Value /Unit
Min./max. operating pressure	0.5 bar/12 bar	Number of program-controlled watering cycles per week	42
Operating temperature range	5 °C to 50 °C	Watering duration	6 x 1 min. – 4 hrs
Flow medium	Clear fresh water	Battery required	1 x 9V alkaline manganese Typ IEC 6LR61
Max. liquid temperature	40 °C	Operating time of the battery	approximately 1 year
Number of program-controlled watering cycles per day	6 individual start times		

9. ACCESSORIES

GARDENA Soil Moisture Sensor

Art. 1188

GARDENA Anti-theft device

Art. 1815-00.791.00 from the GARDENA Service

10. SERVICE/WARRANTY

Service:

Please contact the address on the back page.

Warranty statement:

In the event of a warranty claim, no charge is levied to you for the services provided.

GARDENA Manufacturing GmbH grants a warranty for all original GARDENA new products for two years from the date of original purchase from the retailer, provided that the devices have been for private use only. This manufacturer's warranty does not apply to products acquired second hand. This warranty includes all significant defects of the product that can be proved to be material or manufacturing faults. This warranty is fulfilled by supplying a fully functional replacement product or by repairing the faulty product sent to us free of charge; we reserve the right to choose between these options. This service is subject to the following provisions:

- The product has been used for its intended purpose as per the recommendations in the operating instructions.
- Neither the purchaser nor a third party has attempted to open or repair the product.
- Only Original GARDENA replacement parts and wear parts have been used for operation.

- Presentation of the receipt.

Normal wear and tear of parts and components (such as blades, blade fixing parts, turbines, light bulbs, V-belts/toothed belts, impellers, air filters, spark plugs), visual changes, wear parts and consumables are excluded from the warranty.

This manufacturer's warranty is limited to replacement and repair of products in accordance with the abovementioned conditions. The manufacturer's warranty does not constitute an entitlement to lodge other claims against us as a manufacturer, such as for damages. This manufacturer's warranty does **not**, of course, affect statutory and contractual warranty claims against the dealer/retailer.

The manufacturer's warranty is governed by the law of the Federal Republic of Germany.

In case of a warranty claim, please return the faulty product, together with a copy of the receipt and a description of the fault, with postage paid to the service address.

Consumables:

Faults which occur as a result of incorrectly installed or leaking batteries are not covered by the guarantee.

Damage caused by frost is not covered by the warranty.

DE Produkthaftung

Wir weisen ausdrücklich darauf hin, dass wir in Übereinstimmung mit dem Produkthaftungsgesetz nicht für Schäden haften, die durch unsere Produkte entstehen, wenn diese unsachgemäß und nicht durch einen von uns autorisierten Servicepartner repariert wurden oder wenn keine Original GARDENA Teile oder von uns zugelassene Teile verwendet wurden.

IT Responsabilità del prodotto

In conformità con la Legge tedesca sulla responsabilità del prodotto, con la presente dichiariamo espressamente che decliniamo qualsiasi responsabilità per danni causati dai nostri prodotti qualora non siano stati correttamente riparati presso un partner di assistenza approvato GARDENA o laddove non siano stati utilizzati ricambi originali o autorizzati GARDENA.

EN Product liability

In accordance with the German Product Liability Act, we hereby expressly declare that we accept no liability for damage incurred from our products where said products have not been properly repaired by a GARDENA-approved service partner or where original GARDENA parts or parts authorised by GARDENA were not used.

ES Responsabilidad sobre el producto

De acuerdo con la Ley de responsabilidad sobre productos alemana, por la presente declaramos expresamente que no aceptamos ningún tipo de responsabilidad por los daños ocasionados por nuestros productos si dichos productos no han sido reparados por un socio de mantenimiento aprobado por GARDENA o si no se han utilizado piezas originales GARDENA o piezas autorizadas por GARDENA.

FR Responsabilité

Conformément à la loi relative à la responsabilité du fait des produits défectueux, nous déclarons expressément par la présente que nous déclinons toute responsabilité pour les dommages résultant de nos produits, si lesdits produits n'ont pas été correctement réparés par un partenaire d'entretien agréé GARDENA ou si des pièces d'origine GARDENA ou des pièces agréées GARDENA n'ont pas été utilisées.

PT Responsabilidade pelo produto

De acordo com a lei alemã de responsabilidade pelo produto, declaramos que não nos responsabilizamos por danos causados pelos nossos produtos, caso os tais produtos não tenham sido devidamente reparados por um parceiro de assistência GARDENA aprovado ou se não tiverem sido utilizadas peças GARDENA originais ou peças autorizadas pela GARDENA.

NL Productaansprakelijkheid

Conform de Duitse wet inzake productaansprakelijkheid verklaren wij hierbij uitdrukkelijk dat wij geen aansprakelijkheid aanvaarden voor schade ontstaan uit onze producten waarbij deze producten niet zijn gerepareerd door een GARDENA-erkende servicepartner of waarbij geen originele GARDENA-onderdelen of onderdelen die door GARDENA zijn goedgekeurd zijn gebruikt.

EL Ευθύνη προϊόντος

Σύμφωνα με τον γερμανικό νόμο περί Ευθύνης για τα Προϊόντα, με το παρόν δηλώνουμε ρητώς ότι δεν αποδεχόμαστε καμία ευθύνη για τυχόν ζημιές που προκύπτουν από τα προϊόντα μας εάν αυτά δεν έχουν επισκευαστεί σωστά από κάποιον εγκεκριμένο συνεργάτη επισκευών της GARDENA ή εάν δεν έχουν χρησιμοποιηθεί αυθεντικά εξαρτήματα GARDENA ή εξαρτήματα εγκεκριμένα από την GARDENA.

<p>DE EU-Konformitätserklärung</p> <p>Der Unterzeichner, GARDENA Germany AB, PO Box 7454, S-103 92 Stockholm, Schweden, bescheinigt hiermit, dass die nachstehend aufgeführten Geräte bei Verlassen des Werks die harmonisierten EU-Leitlinien, EU-Normen für Sicherheit und besondere Normen erfüllen. Dieses Zertifikat verliert seine Gültigkeit, wenn die Geräte ohne unsere Genehmigung verändert werden.</p>	<p>IT Dichiarazione di conformità CE</p> <p>La sottoscritta GARDENA Germany AB, PO Box 7454, S-103 92 Stockholm, Svezia, certifica che il prodotto qui di seguito indicato, nei modelli da noi commercializzati, è conforme alle direttive armonizzate UE nonché agli standard di sicurezza UE e agli standard specifici di prodotto. Qualunque modifica apportata al prodotto senza nostra specifica autorizzazione invalida la presente dichiarazione.</p>
<p>EN EC Declaration of Conformity</p> <p>The undersigned, GARDENA Germany AB, PO Box 7454, S-103 92 Stockholm, Sweden, hereby certifies that, when leaving our factory, the units indicated below are in accordance with the harmonised EU guidelines, EU standards of safety and product specific standards. This certificate becomes void if the units are modified without our approval.</p>	<p>ES Declaración de conformidad CE</p> <p>El abajo firmante, GARDENA Germany AB, PO Box 7454, S-103 92 Stockholm, Suecia, certifica por la presente que, cuando salen de la fábrica, las unidades indicadas a continuación cumplen las normas de armonización de la UE, las normas de la UE sobre seguridad y las normas específicas del producto. Este certificado quedará sin efecto si se modifican las unidades sin nuestra autorización.</p>
<p>FR Déclaration de conformité CE</p> <p>Le constructeur, soussigné : GARDENA Germany AB, PO Box 7454, S-103 92 Stockholm, Suède, déclare qu'à la sortie de ses usines le matériel neuf désigné ci-dessous était conforme aux prescriptions des directives européennes énoncées ciaprès et conforme aux règles de sécurité et autres règles qui lui sont applicables dans le cadre de l'Union européenne. Toute modification apportée à cet appareil sans notre accord annule la validité de ce certificat.</p>	<p>PT Declaração de conformidade CE</p> <p>O abaixo-assinado, GARDENA Germany AB, PO Box 7454, S-103 92 Stockholm, Suécia, certifica por este meio que, ao sair da nossa fábrica, as unidades indicadas acima estão em conformidade com as diretrizes uniformizadas da UE, os padrões de segurança da UE e os padrões específicos do produto. Este certificado deixa de ser válido se as unidades forem modificadas sem a nossa aprovação.</p>
<p>NL EG-conformiteitsverklaring</p> <p>De ondergetekende, GARDENA Germany AB, PO Box 7454, S-103 92 Stockholm, Zweden, verklaart hierbij dat de producten die hieronder staan vermeld, wanneer ze onze fabriek verlaten, in overeenstemming zijn met de geharmoniseerde Europese richtlijnen, EU-normen voor veiligheid en productspecifieke normen. Dit certificaat vervalt als de producten worden aangepast zonder onze toestemming.</p>	<p>EL Δήλωση Συμμόρφωσης EK</p> <p>Η υπογεγραμμένη εταιρεία, GARDENA Germany AB, PO Box 7454, S-103 92 Stockholm, Σουηδία, πιστοποιεί ότι, κατά την έξοδο από το εργοστάσιο, οι μονάδες που αναφέρονται κατωτέρω συμμορφώνονται με τις εναρμονισμένες οδηγίες ΕΕ, τα πρότυπα ασφαλείας της ΕΕ και τα συγκεκριμένα πρότυπα προϊόντος. Αυτό το πιστοποιητικό καθίσταται άκυρο εάν οι μονάδες έχουν τροποποιηθεί χωρίς την έγκρισή μας.</p>

Produktbezeichnung: Description of the product: Désignation du produit : Beschrijving van het product: Descrizione del prodotto: Descripción del producto: Descrição do produto: Περιγραφή του προϊόντος:	Bewässerungssteuerung Water Control Programmation d'arrosage Besproeiingsbesturing Unità di controllo per irrigazione Control de riego Controlador de rega Σύστημα ελέγχου ποτίσματος	Anbringingsjahr der CE-Kennzeichnung: Year of CE marking: Année d'apposition du marquage CE : Installatiejaar van de CE-aanduiding: Anno di applicazione della certificazione CE: Colocación del distintivo CE: Ano de marcação pela CE: Έτος σήματος CE:
Produkttyp: Product type: Type de produit : Producttype: Tipo di prodotto: Tipo de producto: Tipo de produto: Τύπος προϊόντος: Master	Artikelnummer: Article number: Référence : Artikelnummer: Codice articolo: Referencia: Número de referencia: Κωδικός είδους: 1892	<div style="text-align: right;">2018</div> Ulm, den 20.12.2018 Ulm, 20.12.2018 Fait à Ulm, le 20.12.2018 Ulm, 20-12-2018 Ulm, 20.12.2018 Ulm, 20.12.2018 Ulm, 20.12.2018 Ulm, 20.12.2018 Ulm, 20.12.2018 Der Bevollmächtigte Authorised representative Le mandataire De gevolmachtigde Persona delegata La persona autorizada O representante Ο εξουσιοδοτημένος
EU-Richtlinien: EC-Directives: Directives CE : EG-richtlijnen: Direttive UE: Directiva CE: Diretivas CE: Οδηγίες EK: 2014/30/EC 2011/65/EC	Hinterlegte Dokumentation: GARDENA Technische Dokumentation, M. Kugler, 89079 Ulm Deposited Documentation: GARDENA Technical Documentation, M. Kugler, 89079 Ulm Documentation déposée : Documentation technique GARDENA, M. Kugler, 89079 Ulm	<div style="text-align: right;">  Reinhard Pompe Vice President </div>

Deutschland / Germany

GARDENA Manufacturing GmbH
Central Service
Hans-Lorenser-Straße 40
D-89079 Ulm
Produktfragen: (+49) 731 490-123
Reparaturen: (+49) 731 490-290
service@gardena.com

Albania

COBALT Sh.p.k.
Rr. Siri Kodra
1000 Tirana

Argentina

Husqvarna Argentina S.A.
Av. del Libertador 5954 –
Piso 11 – Torre B
(C1428ARP) Buenos Aires
Phone: (+54) 11 5194 5000
info.gardena@ar.husqvarna.com

Armenia

Garden Land Ltd.
61 Tigran Mets
0005 Yerevan

Australia

Husqvarna Australia Pty. Ltd.
Locked Bag 5
Central Coast BC
NSW 2252
Phone: (+61) (0) 2 4352 7400
customer.service@
husqvarna.com.au

Austria / Österreich

Husqvarna Austria GmbH
Industriezeile 36
4010 Linz
Tel.: (+43) 732 77 01 01-485
service.gardena@
husqvarnagroup.com

Azerbaijan

Firm Progress
a. Aliyev Str. 26A
1052 Baku

Belgium

Husqvarna België nv/sa
Gardena Division
Rue Egide Van Opheim 111
1180 Uccle / Ukkel
Tel.: (+32) 2 720 92 12
Mail: info@gardena.be

Bosnia / Herzegovina

SILK TRADE d.o.o.
Industrijska zona Bukva bb
74260 Tešanj

Brazil

Husqvarna do Brasil Ltda
Av. Francisco Matarazzo,
1400 – 19ª andar
São Paulo – SP
CEP: 05001-903
Tel: 0800-112252
marketing.br.husqvarna@
husqvarna.com.br

Bulgaria

AGROLAND България АД
бул. 8 Декември, № 13
Офис 5
1700 Студентски град
София
Тел.: (+359) 24 66 6910
info@agroland.eu

Canada / USA

GARDENA Canada Ltd.
100 Summerlea Road
Brampton, Ontario L6T 4X3
Phone: (+1) 905 792 93 30
info@gardenacanada.com

Chile

Maquinarias Agroforestales
Ltda. (Maga Ltda.)
Santiago, Chile
Avda. Chesterton
8355 comuna Las Condes
Phone: (+56) 2 202 4417
Dalton@maga.cl
Zipcode: 7560330

China

Husqvarna (Shanghai)
Management Co., Ltd.
富世华 (上海) 管理有限公司
3F, Benq Square B,
No207, Song Hong Rd.,
Chang Ning District,
Shanghai, P.R.C. 200335
上海市长宁区淞虹路207号明
基广场B座3楼, 邮编: 200335

Colombia

Husqvarna Colombia S.A.
Calle 18 No. 68 D-31, zona
Industrial de Montevideo
Bogotá, Cundinamarca
Tel. 571 2922700 ext. 105
jairo.salazar@husqvarna.com.co

Costa Rica

Compania Exim
Euroberoamericana S.A.
Los Colegios, Moravia,
200 metros al Sur del Colegio
Saint Francis – San José
Phone: (+506) 297 68 83
exim_euro@racsa.co.cr

Croatia

Husqvarna Austria GmbH
Industriezeile 36
4010 Linz
Tel.: (+43) 732 77 01 01-485
service.gardena@husqvarnagroup.com

Cyprus

Med Marketing
17 Digeni Akrita Ave
P.O. Box 27017
1641 Nicosia

Czech Republic

Husqvarna Česko s.r.o.
Türkova 2319/5b
149 00 Praha 4 – Chodov
Bezplatná infolinka :
800 100 425
servis@cz.husqvarna.com

Denmark

GARDENA DANMARK
Lejrvej 19, st.
3500 Værløse
Tlf.: (+45) 70 26 47 70
husqvarna@husqvarna.dk
www.gardena.com / dk

Dominican Republic

BOSQUESA, S.R.L
Carretera Santiago Licey
Km. 5 ½
Esquina Copal II.
Santiago
Dominican Republic
Phone: (+809) 736-0333
joserbosquesa@claro.net.do

Ecuador

Husqvarna Ecuador S.A.
Arupos E1-181 y 10 de
Agosto Quito, Pichincha
francisco.jacome@
husqvarna.com.ec

Estonia

Husqvarna Eesti OÜ
Valdeku 132
EE-11216 Tallinn
info@gardena.ee

Finland

Oy Husqvarna Ab
Gardena Division
Lautatarhankatu 8 B / PL 3
00581 HELSINKI
www.gardena.fi

France

Husqvarna France
9/11 Allée des pierres mayettes
92635 Gennevilliers Cedex
France
http : //www.gardena.com/ fr
N° AZUR: 0 810 00 78 23
(Prix d'un appel local)

Georgia

Transporter LLC
8/57 Beliasvili street
0159 Tbilisi, Georgia
Phone: (+995) 322 14 71 71

Great Britain

Husqvarna UK Ltd
Preston Road
Aycliffe Industrial Park
Newton Aycliffe
County Durham
DL5 6UP
info.gardena@husqvarna.co.uk

Greece

Π.ΠΑΠΑΔΟΠΟΥΛΟΣ ΑΕΒΕ
Λεωφ. Αθηνών 92
Αθήνα
Τ.Κ. 104 42
Ελλάδα
Τηλ. (+30) 210 5193 100
info@papadopoulos.com.gr

Hungary

Husqvarna Magyarország Kft.
Ezred u. 1-3
1044 Budapest
Tel. (+593) 22800739
francisco.jacome@husqvarna.hu

Iceland

Ó. Johnson & Kaaber
Tunguhalsi 1
110 Reykjavik
ooj@ojk.is

Ireland

Husqvarna UK Ltd
Preston Road
Aycliffe Industrial Park
Newton Aycliffe
County Durham
DL5 6UP
info.gardena@husqvarna.co.uk

Italy

Husqvarna Italia S.p.A.
Via Santa Vecchia 15
23868 VALMADRERA (LC)
Phone: (+39) 0341.203.111
assistenza.italia@it.husqvarna.com

Japan

KAKUICHI Co. Ltd.
Sumitomo Realty &
Development Kojimachi
BLDG., 8F
5-1 Nibanncyo
Chiyoda-ku
Tokyo 102-0084
Phone: (+81) 33 264 4721
m_ishihara@kaku-ichi.co.jp

Kazakhstan

LAMED Ltd.
155/1, Tazhibayevoi Str.
050060 Almaty
IP Schmidt
Abayavenue 3B
110 005 Kostanay

Korea

Kyung Jin Trading CO.,LTD.
107-4, SunDuk Bld.,
YangJae-dong,
Seochu-gu,
Seoul, (zipcode: 137-891)
Phone: (+82) (0)2 574-6300

Kyrgyzstan

Alye Maki
av. Moladaya Guardir J 3
720014
Bishkek

Latvia

Husqvarna Latvija SIA
Ulbrokas 19A
LV-1021 Riga
info@gardena.lv

Lithuania

UAB Husqvarna Lietuva
Ateities pl. 77C
LT-52104 Kaunas
info@gardena.lt

Luxembourg

Magasins Jules Neuberg
39, rue Jacques Stas
Luxembourg-Gasperich 2549
Case Postale No. 12
Luxembourg 2010
Phone: (+352) 40 14 01
api@neuberg.lu

Mexico

AFOSA
Av. Lopez Mateos Sur # 5019
Col. La Calma 45070
Zapopan, Jalisco, Mexico
Phone: (+52) 33 3818-3434
iconejo@afosa.com.mx

Moldova

Convel S.R.L.
290A Muncesti Str.
2002 Chisinau

Netherlands

Husqvarna Nederland B.V.
GARDENA Division
Postbus 50131
1305 AC ALMERE
Phone: (+31) 36 521 00 10
info@gardena.nl

Neth. Antilles

Jonka Enterprises N.V.
Sta. Rosa Weg 196
P.O. Box 8200
Curacao
Phone: (+599) 9 767 66 55
pgm@jonka.com

New Zealand

Husqvarna New Zealand Ltd.
PO Box 76-437
Manukau City 2241
Phone: (+64) (0) 9 9202410
support.nz@husqvarna.co.nz

Norway

Husqvarna Norge AS
Gardena Division
Trøskenvæien 36
1708 Sarpsborg
info@gardena.no

Peru

Husqvarna Perú S.A.
Jr. Ramón Cárcamo 710
Lima 1
Tel: (+51) 1 3320400 ext. 416
juan.remuzgo@husqvarna.com

Poland

Husqvarna
Poland Spółka z o.o.
ul. Wysokiego 15 b
03-371 Warszawa
Phone: (+48) 22 330 96 00
gardena@husqvarna.com.pl

Portugal

Husqvarna Portugal, SA
Lagoa - Albarraque
2635 - 595 Rio de Mouro
Tel.: (+351) 21 922 85 30
Fax: (+351) 21 922 85 36
info@gardena.pt

Romania

Madex International Srl
Soseaua Odaii 117 - 123,
RO 013603 Bucuresti, S1
Phone: (+40) 21 352.76.03
madex@ines.ro

Russia / Россия

OOO „Хускварна“
141400, Московская обл.,
г. Химки,
улица Ленинградская,
владение 39, стр.6
Бизнес Центр
„Химки Бизнес Парк“,
помещение ОВ02_04
http://www.gardena.ru

Serbia

Domel d.o.o.
Autoput za Novi Sad bb
11273 Belgrade
Phone: (+381) 1 18 48 88 12
miroslav.jejina@domel.rs

Singapore

Hy-Ray PRIVATE LIMITED
40 Jalan Pemimpin
#02-08 Tat Ann Building
Singapore 577185
Phone: (+65) 6253 2277
shiyang@hyray.com.sg

Slovak Republic

Husqvarna Česko s.r.o.
Türkova 2319/5b
149 00 Praha 4 – Chodov
Bezplatná infolinka:
800 154 044
servis@sk.husqvarna.com

Slovenia

Husqvarna Austria GmbH
Industriezeile 36
4010 Linz
Tel. : (+43) 732 77 01 01-485
service.gardena@
husqvarnagroup.com

South Africa

Husqvarna
South Africa (Pty) Ltd
Postnet Suite 250
Private Bag X6,
Cascades, 3202
South Africa
Phone: (+27) 33 846 9700
info@gardena.co.za

Spain

Husqvarna España S.A.
Calle de Rivas nº 10
28052 Madrid
Phone: (+34) 91 708 05 00
atencioncliente@gardena.es

Suriname

Agrofix n.v.
Verlengde Hogestraat #22
Phone: (+597) 472426
agrofix@sr.net
Pobox : 2006
Paramaribo
Suriname – South America

Sweden

Husqvarna AB
Gardena Division
5-561 82 Huskvarna
gardenaorder@husqvarna.se

Switzerland / Schweiz

Husqvarna Schweiz AG
Consumer Products
Industriestrasse 10
5506 Mägenwil
Phone: (+ 41) (0) 62 887 37 90
info@gardena.ch

Turkey

Dost Bahçe Diş Ticaret
Mümesillik A.Ş
Yunus Mah. Adil Sok. No: 3
İc Kapi No: 1 Kartal
34873 Istanbul
Phone: (+90) 216 38 93 939
info@dostbahce.com.tr

Ukraine / Україна

TOB «Хускварна Україна»
вул. Васильківська, 34,
офіс 204-г
03022, м. Київ
Тел. (+38) 044 498 39 02
info@gardena.ua

Uruguay

FELI SA
Entre Rios 1083 CP 11800
Montevideo – Uruguay
Tel : (+598) 22 03 18 44
info@felisa.com.uy

Venezuela

Corporación Casa y Jardín C.A.
Av. Caroni, Edif. Trezmen, PB.
Colinas de Bello Monte.
1050 Caracas.
Tlf : (+58) 212 992 33 22
info@casayjardin.net.ve



1892-20.960.02/0619

© GARDENA Manufacturing GmbH; D-89070 Ulm; http://www.gardena.com