



D Betriebsanleitung
Bewässerungsventil

GB Operating Instructions
Irrigation Valve

F Mode d'emploi
Electrovanne

NL Instructies voor gebruik
Beregeningsventiel

S Bruksanvisning
Ventil

DK Brugsanvisning
Vandingsventil

FIN Käyttöohje
Kasteluventtiili

N Bruksanvisning
Vanningsventil

I Istruzioni per l'uso
Valvola cordless

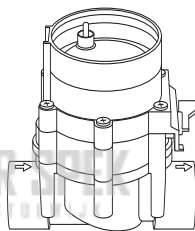

9V Art. 1251

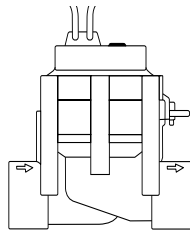

24V Art. 1278

E Manual de instrucciones
Válvula de riego

P Instruções de utilização
Válvula de Irrigação

RO Instrucțiuni de utilizare
Electrovalvă

TR Kullanma kılavuzu
Solenoid vana

GARDENA Irrigation Valve



Translation of the original instructions from German.

Please read these operating instructions carefully and observe the notes given. Use these operating instructions to familiarise yourself with the Irrigation Valve, its correct use and the notes on safety.



For safety reasons, children under 16 as well as persons not familiar with these operating instructions should not use this Irrigation Valve. Persons with reduced physical or mental abilities may use the product only if they are supervised or instructed by a responsible person. Children must be supervised to ensure that they do not play with the product. Never operate the product when you are tired, ill or under the influence of alcohol, drugs or medicine.

→ Please keep these operating instructions in a safe place.

Contents

1. Where to Use Your GARDENA Irrigation Valve	15
2. Safety Instructions	16
3. Initial Operation	17
4. Operation	20
5. Trouble-Shooting	20
6. Protection against Frost	21
7. Technical Data	23
8. Service / Warranty	23

1. Where to Use Your GARDENA Irrigation Valve

Intended use

The Irrigation Valves are intended solely for outdoor use for fully automatic control of individual irrigation systems. It is a benefit to arrange a watering system into separate sections in case of varying watering needs for different plant areas or if there is insufficient water available for simultaneous operation of the entire watering system.

The Irrigation Valve is installed upstream in the watering system (e. g. Pop-up Sprinklers; Micro-Drip-System), for example, in the ground.

Please note

Compliance with the enclosed operating instructions provided by GARDENA is a prerequisite for proper use of the Irrigation Valve.

9V:

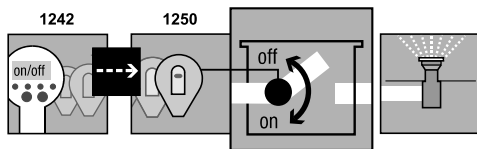

The Irrigation Valve **1251** forms part of an irrigation system in conjunction with the Programming Unit **1242** and the Control Unit **1250**.

24V:

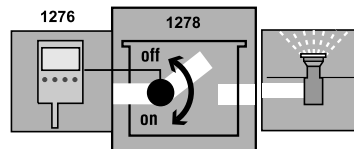

The Irrigation Valve **1278** forms part of an irrigation system in conjunction with the Watering Controller **1276**.



The Irrigation Valve must only be used in conjunction with the – 9 V Control Units; Radio Receivers / 24 V Watering Controller – approved by GARDENA.

2. Safety Instructions

Blocking the Irrigation Valve

→ Please observe the notes on safety in the operating instructions.

9 V and 24 V products are not interchangeable.

→ **In the case of dirty water, the GARDENA Central Filter Art. No. 1510 must be installed upstream in the watering system.**

Water pressure

The function of your watering system depends on the available water pressure. Therefore, care should be taken not to overlap watering cycles of the various watering circuits and to ensure that the watering circuits you have planned will be supplied with sufficient water at an adequate pressure.

Please refer to the planning instructions in the special brochure entitled “Watering Systems – Sprinkler System Planning Guide” available from GARDENA.

3. Initial Operation

If the Irrigation Valve is installed below ground level, it must be installed in a sturdy and step-proof valve mount ① (valve box) e.g. GARDENA Art. No. 1254/1255/1290/1292.

Install the valve mount:

1. Draw up a plan (an example is shown in the figure below).

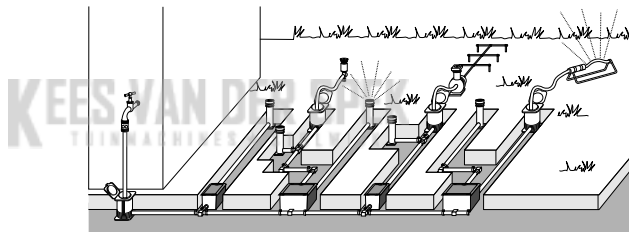
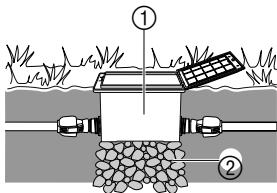

Additional information is provided in the GARDENA Sprinkler System Planning Guide which is available from your GARDENA dealer.

2. For underground installation, place a layer of coarse gravel ② underneath the valve mount ①.

This ensures proper drainage of the box.

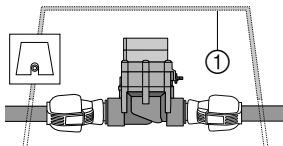

3. Install the valve box with the top edge of the box at ground level.

This avoids damage when mowing the lawn.

Please refer to the relevant operating instructions for information on how to install the Irrigation Valves in GARDENA Valve Boxes V1 and V3.

Installing the Irrigation Valve without a Valve Box:

The integrated solenoid valve works only correctly with the Irrigation Valve connected in flow direction.



Flow direction

→ Pay attention to the flow direction (arrows) when installing the Irrigation Valve ③.

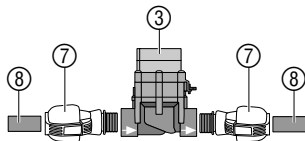

→ Seal the screw connections with PTFE sealing tape, **Art. 7219**.

Connecting GARDENA Connecting pipes ⑧ (2700/2701/2704/2705/2718) or other commercially available connecting pipes:

1. Screw a **GARDENA Connector ⑦ 2763** (1" = 25 mm) / **2769** (5/4" = 32 mm) into the Irrigation Valve ③.
2. Connect the GARDENA connecting pipes ⑧ or other commercially available connecting pipes (25 mm / 32 mm).

**Connect Soil Moisture Sensor
or Rain Sensor electronic
(optional):**

In conjunction with the programmed watering time, the moisture level of the soil or the natural precipitation can be taken into account for each Irrigation Valve.

When a sufficient moisture content of the soil is reached, a programme may be interrupted or activation of a programme may be suppressed.

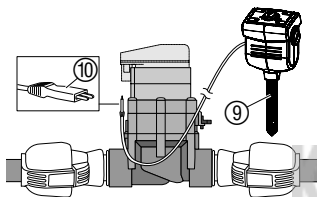

1. Place the Soil Moisture Sensor ⑨ in the area to be irrigated – or – the Rain Sensor electronic (if necessary with an extension cable) **outside** of the area to be irrigated.

2. **9V**: Plug the connector ⑩ into the sensor socket of the Control Unit.

24V: Insert plug ⑩ in the sensor connection of the Watering Control System **Art. 1276** (s. Operating Instructions **Art. 1276**).

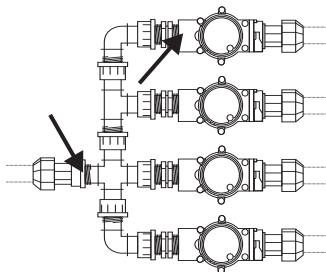

Conventional installation :

If using **Art. 2750 / 2751 / 2752 / 2753 / 2755**

the points marked with an arrow must be sealed with sealing tape (e.g. **Art. No. 7219**).

4. Operation

Adjusting valve control:

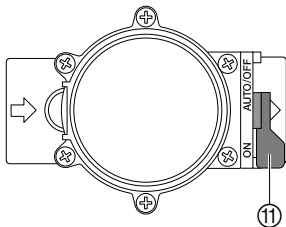

Fully Automatic Control:

→ Set selection lever ⑪ to “**AUTO/OFF**”.

Programme-controlled water flow to the watering system according to the programming in the Control Unit / Radio Receiver.

An automatically opened valve cannot be closed manually.

Manual Control:

→ Set selection lever ⑪ to “**ON**”.

Permanent water flow, independent of the programming.

5. Trouble-Shooting

Fault	Possible Causes	Remedy
Solenoid valve does not open, no water flow	No water supply.	→ Turn on water supply.
	Control Unit / Radio Receiver / Watering Controller not connected correctly to Irrigation Valve.	→ Connect Control Unit / Radio Receiver / Watering Controller correctly to Irrigation Valve.

Fault	Possible Causes	Remedy
Solenoid valve does not close, continuous water flow	Solenoid valve installed opposite to flow direction.	→ Turn solenoid valve (observe the flow direction).
	Selection lever ⑪ set to “ON”.	→ Set selection lever ⑪ to “AUTO/OFF”.



In the event of other faults please contact **GARDENA Service**.
Repairs should only be carried out by **GARDENA service centres or dealers** authorised by GARDENA.

6. Protection against Frost

Winter storage:

GARDENA Irrigation Valves are intended for outdoor use and are only frost-proof to a limited extent. The only way to protect your Irrigation Valves completely is to remove the valves before the frosty season begins. Alternatively, you can drain the pipeline system upstream and downstream of the Irrigation Valve.

Emptying the pipeline system UPSTREAM of the valve:

1. Turn off the tap and disconnect the hose between the tap and the **GARDENA Water Connection Point Art. No. 2722 / Art. No. 2795**.

This allows the air to flow freely and the supply line can be drained using the drain valve integrated in the Connecting Point.

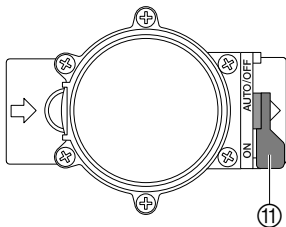

Emptying the pipeline system DOWNSTREAM of the valve:

This requires that the Connecting Point be installed deeper in the ground than the Irrigation Valve.

2. If the watering system is directly connected to the water tap, turn off the water supply and open the venting tap.
3. Set the selection lever ⑪ of all valves to the “ON” position.
4. If you are using the GARDENA Valve Box V3, make sure you open the integrated drain cap.

Requirement: The Drainage Valve must be installed deeper than or at the same depth as the Irrigation Valve.

→ Install a GARDENA Drainage Valve **Art. No. 2760** immediately after the valve.

The system is drained automatically via the the GARDENA Drainage Valve.

→ If neither of these requirements is fulfilled, the valve must be removed and stored in a place safe from frost.

Disposal:

*(in accordance with
Directive 2012/19/EU)*



The product must not be added to normal household waste. It must be disposed of in line with local environmental regulations.

→ Important: Make sure that the unit is disposed of via your municipal recycling collection centre.

7. Technical Data

Solenoid Valve	9V (Art. No. 1251)	24V (Art. No. 1278)
Voltage	9V DC	24V AC
Operating pressure	0.5 to 12 bar	0.5 to 12 bar
Flow medium	clean fresh water	clean fresh water
Max. water temperature	40 °C	40 °C

8. Service / Warranty

GARDENA guarantees this product for 2 years (from date of purchase). This guarantee covers all serious defects of the unit that can be proved to be material or manufacturing faults. Under warranty we will either replace the unit or repair it free of charge if the following conditions apply:

- The unit must have been handled properly and in keeping with the requirements of the operating instructions.
- Neither the purchaser or a non-authorized third party have attempted to repair the unit.

Faults with the Irrigation Valve caused by incorrectly installed batteries or leaking batteries in the Control Unit / Radio Receiver are not covered by the guarantee.

This manufacturer's guarantee does not affect the user's existing warranty claims against the dealer/seller.

If a fault occurs with your Irrigation Valve, please return the faulty unit together with a copy of the receipt and a description of the fault, with postage paid to one of the GARDENA Service Centres listed on the back of these operating instructions.

KEES VAN DER SPEK
TUINMACHINES ★ STOLWIJK

Bild Nr. Picture No.	Ersatzteil-Nr. Spare Part No.	Bezeichnung Bewässerungsventil 9V/1" Art.-Nr. 1251	Description Watering Valve 9V/1" Art. No. 1251
19 - 36	1251-00.500.00	Bew. Ventil 9V/1" (=Art.1251)	Watering valve 9V/1" (= Art.1251)
19	1815-00.610.27	Steuerdüse, rot	Control nozzle, red
20	1251-00.500.26	Ventildeckel	Valve cover
21	913-00.680.01	O-Ring 7,5 x 2	O-Ring 7,5 x 2
22+21	1251-00.701.00	Kücken, vollst.	Mixer dial, cpl.
23	1672-00.600.11	O-Ring 24 x 2	O-Ring 24 x 2
24	1174-00.617.00	Magnetplatte, vollst.	Magnetic plate, cpl.
25	1174-00.610.11	Druckfeder, klein	Pressure spring, small
26	1251-00.510.00	Elektromagnet, vollst.	Electric magnet, cpl.
27	1174-00.610.07	Blechschraube 3,5 x 25-F-H	Sheet metal screw 3,5 x 25-F-H
28	1251-00.500.21	Blechschraube 4,2 x 60	Sheet metal screw 4,2 x 60 (6 x)
29	1174-00.610.08	Druckfeder, gross	Pressure spring, large
30 - 34	1251-00.520.00	Membrane, vollst.	Diaphragm
35	1251-00.500.11	Stützring	Support ring
36	1251-00.500.06	Ventilkörper	Valve body
	1251-00.540.00	Feinfilter	Fine filter



Bewässerungsventil
Art. 1251

KES VAN DER SPEK
TUINMACHIEN & STOLWIJZ

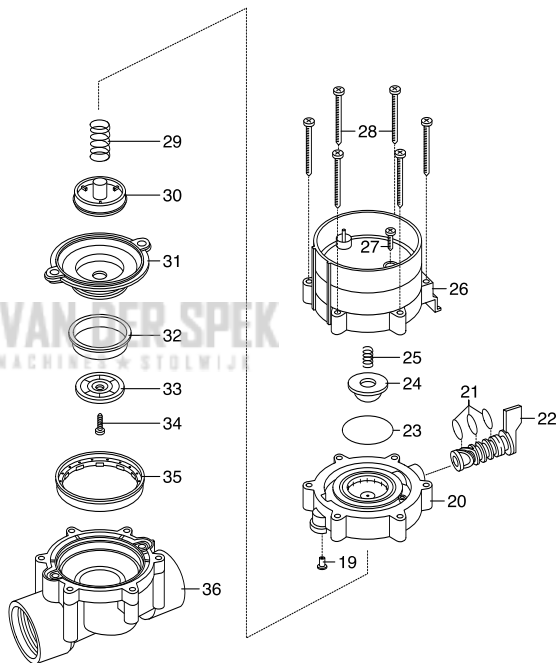

D Produkthaftung

Wir weisen ausdrücklich darauf hin, dass wir nach dem Produkthaftungsgesetz nicht für durch unsere Geräte hervorgerufene Schäden einzustehen haben, sofern diese durch unsachgemäße Reparatur verursacht oder bei einem Teileaustausch nicht unsere Original GARDENA Teile oder von uns freigegebene Teile verwendet werden und die Reparatur nicht vom GARDENA Service oder dem autorisierten Fachmann durchgeführt wird. Entsprechendes gilt für Ergänzungssteile und Zubehör.

GB Product Liability

We expressly point out that, in accordance with the product liability law, we are not liable for any damage caused by our units if it is due to improper repair or if parts exchanged are not original GARDENA parts or parts approved by us, and, if the repairs were not carried out by a GARDENA Service Centre or an authorised specialist. The same applies to spare parts and accessories.

F Responsabilité

Nous vous signalons expressément que GARDENA n'est pas responsable des dommages causés par ses appareils, dans la mesure où ces dommages seraient causés suite à une réparation non conforme, dans la mesure où, lors d'un échange de pièces, les pièces d'origine GARDENA n'auraient pas été utilisées, ou si la réparation n'a pas été effectuée par le Service Après-Vente GARDENA ou l'un des Centres SAV agréés GARDENA. Ceci est également valable pour tout ajout de pièces et d'accessoires autres que ceux préconisés par GARDENA.

NL Productaansprakelijkheid

Wij wijzen er nadrukkelijk op, dat wij op grond van de wet aansprakelijkheid voor producten niet aansprakelijk zijn voor schade ontstaan door onze apparaten, indien deze door onvakkundige reparatie veroorzaakt zijn, of er bij het uitwisselen van onderdelen geen gebruik gemaakt werd van onze originele GARDENA onderdelen of door ons vrijgegeven onderdelen en de reparatie niet door de GARDENA technische dienst of de bevoegde vakman uitgevoerd werd. Ditzelfde geldt voor extra-onderdelen en accessoires.

S Produktansvar

Tillverkaren är inte ansvarig för skada som orsakats av produkten om skadan beror på att produkten har reparerats felaktigt eller om, vid reparation eller utbyte, andra än Original GARDENA reservdelar har använts. Samma sak gäller för kompletteringsdelar och tillbehör.

DK Produktansvar

Vi gør udtrykkeligt opmærksom på at i henhold til produktansvarsloven er vi ikke ansvarlige for skader forårsaget af vores udstyr, hvis det skyldes uautoriserede reparationer eller hvis dele er skiftet ud og der ikke er anvendt originale GARDENA dele eller dele godkendt af os, eller hvis reparationerne ikke er udført af GARDENA-service eller en autoriseret fagmand. Det samme gælder for ekstra udstyr og tilbehør.

<p>D EG-Konformit�tserkl�ring</p> <p>Der Unterzeichnete Husqvarna AB, 561 82 Huskvarna, Sweden best�tigt, dass die nachfolgend bezeichneten Ger�te in der von uns in Verkehr gebrachten Ausf�hrung die Anforderungen der harmonisierten EU-Richtlinien, EU-Sicherheitsstandards und produktspezifischen Standards erf�llen. Bei einer nicht mit uns abgestimmten �nderung der Ger�te verliert diese Erkl�rung ihre G�ltigkeit.</p>	<p>DK EU Overensstemmelse certificat</p> <p>Undertegnede Husqvarna AB, 561 82 Huskvarna, Sweden bekr�fter hermed, at enheder listet herunder, ved afsendelse fra fabrikken, er i overensstemmelse med harmoniserede EU retningslinier, EU sikkerhedsstandarder og produkt-specifikationsstandarder. Dette certificat tr�der ud af kraft hvis enhederne er �ndret uden vor godkendelse.</p>
<p>GB EU Declaration of Conformity</p> <p>The undersigned Husqvarna AB, 561 82 Huskvarna, Sweden, hereby certifies that, when leaving our factory, the units indicated below are in accordance with the harmonised EU guidelines, EU standards of safety and product specific standards. This certificate becomes void if the units are modified without our approval.</p>	<p>FIN EY-vaatimustenmukaisuusvakuutus</p> <p>Allekirjoittanut Husqvarna AB, 561 82 Huskvarna, Sweden vakuuttaa, ett� allamainitut laitteet t�yttävät tehtaaltamme l�htiess�n yhdenmukaistettujen EY-direktiivien, EY-turvallisuusstandardien ja tuotekohtaisten standardien vaatimukset. Laitteisiin tehdyt muutokset, joista ei ole sovittu kanssamme, johtavat t�m�n vakuutuksen raukkaamiseen.</p>
<p>F Certificat de conformit� aux directives europ�ennes</p> <p>Le constructeur, soussign� : Husqvarna AB, 561 82 Huskvarna, Sweden, d�clare qu'� la sortie de ses usines le mat�riel neuf d�sign� ci-dessous �tait conforme aux prescriptions des directives europ�ennes �nonc�es ci-apr�s et conforme aux r�gles de s�curit� et autres r�gles qui lui sont applicables dans le cadre de l'Union europ�enne. Toute modification port�e sur ce produit sans l'accord express de Husqvarna supprime la validit� de ce certificat.</p>	<p>I Dichiarazione di conformit� alle norme UE</p> <p>La sottoscritta Husqvarna AB, 561 82 Huskvarna, Sweden, certifica che il prodotto qui di seguito indicato, nei modelli da noi commercializzati, � conforme alle direttive armonizzate UE nonch� agli standard di sicurezza e agli standard specifici di prodotto. Qualunque modifica apportata al prodotto senza nostra specifica autorizzazione invalida la presente dichiarazione.</p>
<p>NL EU-overeenstemmingsverklaring</p> <p>Ondergetekende Husqvarna AB, 561 82 Huskvarna, Sweden, bevestigt, dat het volgende genoemde apparaat in de door ons in de handel gebrachte uitvoering voldoet aan de eis van, en in overeenstemming is met de EU-richtlijnen, de EU-veiligheidsstandaard en de voor het product specifieke standaard. Bij een niet met ons afgestemde verandering aan het apparaat verliest deze verklaring haar geldigheid.</p>	<p>E Declaraci�n de conformidad de la UE</p> <p>El que subscribe Husqvarna AB, 561 82 Huskvarna, Sweden, declara que la presente mercancia, objeto de la presente declaraci�n, cumple con todas las normas de la UE, en lo que a normas t�cnicas, de homologaci�n y de seguridad se refiere. En caso de realizar cualquier modificaci�n en la presente mercancia sin nuestra previa autorizaci�n, esta declaraci�n pierde su validez.</p>
<p>S EU Tillverkarintyg</p> <p>Undertecknad firma Husqvarna AB, 561 82 Huskvarna, Sweden, intygar h�med att nedan n�mnda produkter �verensst�mmer med EU:s direktiv, EU:s s�kerhetsstandard och produktspecifikation. Detta intyg upph�r att g�lla om produkten �ndras utan v�rt tillst�nd.</p>	<p>P Certificado de conformidade da UE</p> <p>Os abaixo mencionados Husqvarna AB, 561 82 Huskvarna, Sweden, por este meio certificam que ao sair da f�brica o aparelho abaixo mencionado est� de acordo com as directrizes harmonizadas da UE, padr�es de seguran�a e de produtos espec�ficos. Este certificado ficar� nulo se a unidade for modificada sem a nossa aprova�o.</p>

<p>RO UE - Certificat de conformitate</p> <p>Prin prezenta Husqvarna AB, 561 82 Huskvarna, Sweden, certifica faptul ca, in momentul in care produsele mentionate mai jos ies din fabrica sunt in concordanta cu directivele UE, standardele de siguranta UE si standardele specifice ale produsului UE. Acest certificat devine nul in cazul modificării aparatului fără aprobarea noastră.</p>	<p>EU-Richtlinien: EU directives: Directives européennes : EU-richtlijnen: EU direktiv: EU Retningslinier: EY-direktiivit: Direttive UE: Normativa UE: Directrices da UE: Directive UE:</p>
<p>Bezeichnung des Gerätes: Bewässerungsventil Description of the unit: Irrigation Valve Désignation du matériel : Electrovanne Omschrijving van het apparaat: Beregeningsventiel Produktbeskrivning: Ventil Beskrivelse af enhederne: Vandingsventil Laitteiden nimitys: Kasteluventtiili Descrizione del prodotto: Valvola cordless Descripción de la mercancía: Válvula de riego Descrição do aparelho: Válvula de Irrigação Descrierea articolelor: Electrovalvă</p>	<p style="text-align: right; font-size: 1.2em;">2011/65/EC</p> <p>Hinterlegte Dokumentation: GARDENA Technische Dokumentation M. Kugler 89079 Ulm Deposited Documentation: GARDENA Technical Documentation M. Kugler 89079 Ulm Documentation déposée : Documentation technique GARDENA M. Kugler 89079 Ulm</p>
<p>Typ: Art.-Nr.: Type: Art. No.: Type : Référence : Typ: Art. nr.: Type: Art.nr.: 1251 Type: Varenr. : Typpit: Art.-n:o. : 1278 Modello: Art. : Tipo: Art. Nº: Tipo: Art. Nº: Tipuri: Nr art.:</p>	<p>Anbringungs-jahr der CE-Kennzeichnung: Year of CE marking: Date d'apposition du marquage CE : Installatiejaar van de CE-aanduiding: CE-Märkningsår: CE-Mærkningsår: 2014 CE-merkin kiinnitysvuosi: Anno di rilascio della certificazione CE: Colocación del distintivo CE: Ano de marcação pela CE: Anul de marcare CE:</p>

Ulm, den 14.01.2014	Der Bevollmächtigte
Ulm, 14.01.2014	Authorised representative
Fait à Ulm, le 14.01.2014	Représentant légal
Ulm, 14-01-2014	Gemachtigde
Ulm, 2014.01.14.	Behörig Firmatecknare
Ulm, 14.01.2014	Teknisk direktør
Ulmissa, 14.01.2014	Valtuutettu edustaja
Ulm, 14.01.2014	Rappresentante autorizzato
Ulm, 14.01.2014	Representante autorizado
Ulm, 14.01.2014	Representante autorizado
Ulm, 14.01.2014	Vodja tehničnega oddelka



Reinhard Pompe
(Vice President)

KES VAN DER SPEK
INMACHINES ★ STOLWIJK

Deutschland / Germany

GARDENA GmbH
Central Service
Hans-Lorenser-Straße 40
D-89079 Ulm
Produktfragen:
(+49) 731 490-123
Reparaturen:
(+49) 731 490-290
service@gardena.com

Albania

COBALT Sh.p.k.
Rr. Siri Kodra
1000 Tirana

Argentina

Husqvarna Argentina S.A.
Av.del Libertador 5954 -
Piso 11 - Torre B
(C1428ARP) Buenos Aires
Phone: (+54) 11 5194 5000
info.gardena@
ar.husqvarna.com

Armenia

Garden Land Ltd.
61 Tigran Mets
0005 Yerevan

Australia

Husqvarna Australia Pty. Ltd.
Locked Bag 5
Central Coast BC
NSW 2252
Phone: (+61) (0) 2 4352 7400
customer.service@
husqvarna.com.au

Austria / Österreich

Husqvarna Austria GmbH
Consumer Products
Industriezeile 36
4010 Linz
Tel.: (+43) 732 77 01 01 - 90
consumer.service@husqvarna.at

Azerbaijan

Firm Progress
a. Aliyev Str. 26A
1052 Baku

Belgium

GARDENA Belgium NV/SA
Sterrebeekstraat 163
1930 Zaventem
Phone: (+32) 2 720 92 12
Mail: info@gardena.be

Bosnia / Hercegovina

SILK TRADE d.o.o.
Industrijska zona Bukva bb
74260 Tešanj

Brazil

Husqvarna do Brasil Ltda
Av. Francisco Matarazzo,
1400 – 19º andar
São Paulo - SP
CEP: 05001-903
Tel: 0800-112252
marketing.br.husqvarna@
husqvarna.com.br

Bulgaria

Хускварна България ЕООД
Бул. „Андрей Ляпчев“ № 72
1799 София
Tel.: (+359) 02/9753076
www.husqvarna.bg

Canada / USA

GARDENA Canada Ltd.
100 Summerlea Road
Brampton, Ontario L6T 4X3
Phone: (+1) 905 792 93 30
info@gardenacanada.com

Chile

Maquinarias Agroforestales
Ltda. (Maga Ltda.)
Santiago, Chile
Avda. Chesterton
8355 comuna Las Condes
Phone: (+56) 2 202 4417
Dalton@maga.cl
Zipcode: 7560330

Temuco, Chile
Avda. Valparaíso # 01466
Phone: (+56) 45 222 126
Zipcode: 4780441

China

Husqvarna (China) Machinery
Manufacturing Co., Ltd.
No. 1355, Jia Xin Rd.,
Ma Lu Zhen, Jia Ding Dist.,
Shanghai
201801
Phone: (+86) 21 59159629
Domestic Sales
www.gardena.com.cn

Colombia

Husqvarna Colombia S.A.
Calle 18 No. 68 D-31, zona
Industrial de Montevideo
Bogotá, Cundinamarca
Tel. 571 2922700 ext. 105
jairo.salazar@
husqvarna.com.co

Costa Rica

Compania Exim
Euroiberoamericana S.A.
Los Colegios, Moravia,
200 metros al Sur del Colegio
Saint Francis - San José
Phone: (+506) 297 68 83
exim_euro@racsa.co.cr

Croatia

SILK ADRIA d.o.o.
Josipa Lončara 3
10090 Zagreb
Phone: (+385) 1 3794 580
silk.adria@zg.t-com.hr

Cyprus

Med Marketing
17 Digeni Akrita Ave
P.O. Box 27017
1641 Nicosia

Czech Republic

Husqvarna Česko s.r.o.
Türkova 2319/5b
149 00 Praha 4 – Chodov
Bezplatná infolinka:
800 100 425
servis@cz.husqvarna.com

Denmark

GARDENA / Husqvarna
Consumer Outdoor Products
Salgsafdeling Danmark
Box 9003
S-200 39 Malmö
info@gardena.dk

Dominican Republic

BOSQUESA, S.R.L
Carretera Santiago Licey
Km. 5 ½
Esquina Copal II.
Santiago, Dominican Republic
Phone: (+809) 736-0333
joserbosquesa@claro.net.do

Ecuador

Husqvarna Ecuador S.A.
Arupos E1-181 y 10 de Agosto
Quito, Pichincha
Tel. (+593) 22800739
francisco.jacome@
husqvarna.com.ec

Estonia

Husqvarna Eesti OÜ
Consumer Outdoor Products
Kesk tee 10, Aaviku küla
Rae vald
Harju maakond
75305 Estonia
kontakt.etj@husqvarna.ee

Finland

Oy Husqvarna Ab
Consumer Outdoor Products
Lautatarhankatu 8 B/ PL 3
00581 HELSINKI
info@gardena.fi

France

GARDENA France
Immeuble Exposial
9-11 allée des Pierres Mayettes
ZAC des Barbannières, B.P. 99
-F- 92232 GENNEVILLIERS
cedex
Tél. (+33) 01 40 85 30 40
service.consommateurs@
gardena.fr

Georgia

ALD Group
Beliasvili 8
1159 Tbilisi

Great Britain

Husqvarna UK Ltd
Preston Road
Aycliffe Industrial Park
Newton Aycliffe
County Durham
DL5 6UP
info.gardena@
husqvarna.co.uk

Greece

ΕΛΛΑΣ Α.Ε.Β.Ε.
Υπ/μα Ηφείστου 33Α
Βλ. Πλ. Κορωπίου
194 00 Κορωπί Αττικής
V.A.T. EL094094640
Phone: (+30) 210 66 20 225
info@husqvarna-consumer.gr

Hungary

Husqvarna Magyarorszag Kft.
Ezred u. 1-3
1044 Budapest
Telefon: (+36) 1 251-4161
vevoszolgalat.husqvarna@
husqvarna.hu

Iceland

Ó. Johnson & Kaaber
Tunguhalsi 1
110 Reykjavik
ooj@ojk.is

Ireland

Husqvarna UK Ltd
Preston Road
Aycliffe Industrial Park
Newton Aycliffe
County Durham
DL5 6UP
info.gardena@
husqvarna.co.uk

Italy

Husqvarna Italia S.p.A.
Via Como 72
23868 VALMADRERA (LC)
Phone: (+39) 0341.203.111
info@gardenaitalia.it

Japan

KAUKIUCHI Co. Ltd.
Sumitomo Realty &
Development Kojimachi
BLDG., 8F
5-1 Nibanicyo
Chiyoda-ku
Tokyo 102-0084
Phone: (+81) 33 264 4721
m_ishihara@kaku-ichi.co.jp

Kazakhstan

LAMED Ltd.
155/1, Tazhibayevoi Str.
050060 Almaty
IP Schmidt
Abayavenue 3B
110 005 Kostanay

Korea

Kyung Jin Trading CO.,LTD.
107-4, SunDuk Bld.,
YangJae-dong,
Seocho-gu,
Seoul, (zipcode: 137-891)
Phone: (+82) (0)2 574-6300

Kyrgyzstan

Alye Maki
av. Moladaya Guardir J 3
720014 Bishkek

Latvia

Husqvarna Latvija
Consumer Outdoor Products
Bākuži iela 6
LV-1024 Rīga
info@husqvarna.lv

Lithuania

UAB Husqvarna Lietuva
Consumer Outdoor Products
Ateities pl. 77C
LT-52104 Kaunas
centras@husqvarna.lt

Luxembourg

Magasins Jules Neuberg
39, rue Jacques Stas
Luxembourg-Gasperich 2549
Case Postale No. 12
Luxembourg 2010
Phone: (+352) 40 14 01
api@neuberg.lu

Mexico

AFOSA
Av. Lopez Mateos Sur # 5019
Col. La Calma 45070
Zapopan, Jalisco
Mexico
Phone: (+52) 33 3818-3434
icornejo@afosa.com.mx

Moldova

Convel S.R.L.
290A Muncestii Str.
2002 Chisinau

Netherlands

GARDENA Nederland B.V.
Postbus 50176
1305 AD ALMERE
Phone: (+31) 36 521 00 00
info@gardena.nl

Neth. Antilles

Jonka Enterprises N.V.
Sta. Rosa Weg 196
P.O. Box 8200
Curaçao
Phone: (+599) 9 767 66 55
pgm@jonka.com

New Zealand

Husqvarna New Zealand Ltd.
PO Box 76-437
Manukau City 2241
Phone: (+64) (0) 9 9202410
support.nz@husqvarna.co.nz

Norway

GARDENA
Husqvarna Consumer
Outdoor Products
Salgskontor Norge
Klevertveien 6
1540 Vestby
info@gardena.no

Peru

Husqvarna Perú S.A.
Jr. Ramón Cárcamo 710
Lima 1
Tel: (+51) 1 3320400
ext. 416
juan.remuzgo@husqvarna.com

Poland

Husqvarna
Poland Spółka z o.o.
ul. Wysockiego 15 b
03-371 Warszawa
Zapopan, Jalisco
Phone: (+48) 22 330 96 00
gardena@husqvarna.com.pl

Portugal

Husqvarna Portugal, SA
Lagoa - Albarraque
2635 - 595 Rio de Mouro
Tel.: (+351) 21 922 85 30
Fax : (+351) 21 922 85 36
info@gardena.pt

Romania

Madex International Srl
Soseaua Odaii 117-123,
RO 013603
Bucuresti, S 1
Phone: (+40) 21 352.76.03
madex@ines.ro

Russia

ООО „Хускварна“
141400, Московская обл.,
г. Химки,
улица Ленинградская,
владение 39, стр.6
Бизнес Центр
„Химки Бизнес Парк“,
помещение ОВ02_04

Serbia

Domel d.o.o.
Autoput za Novi Sad bb
11273 Belgrade
Phone: (+381) 1 18 48 88 12
miroslav.jejina@domel.rs

Singapore

Hy-Ray PRIVATE LIMITED
40 Jalan Pemimpin
#02-08 Tat Ann Building
Singapore 577185
Phone: (+65) 6253 2277
shiyang@hyray.com.sg

Slovak Republic

Husqvarna Česko s.r.o.
Türkova 2319/5b
149 00 Praha 4 - Chodov
Bezplatná infolinka:
800 154 044
servis@sk.husqvarna.com

Slovenia

Husqvarna Austria GmbH
Consumer Products
Industriezeile 36
4010 Linz
Tel.: (+43) 732 77 01 01-90
consumer.service@
husqvarna.at

South Africa

Husqvarna
South Africa (Pty) Ltd
Postnet Suite 250
Private Bag X6,
Cascades, 3202
South Africa
Phone: (+27) 33 846 9700
info@gardena.co.za

Spain

Husqvarna España S.A.
C/ Basauri, nº 6
La Florida
28023 Madrid
Phone: (+34) 91 708 05 00
atencioncliente@gardena.es

Suriname

Agrofix n.v.
Verlengde Hogestraat # 22
Phone: (+597) 472426
agrofix@sr.net
Pobox : 2006
Paramaribo
Suriname-South America

Sweden

Husqvarna AB
S-561 82 Huskvarna
info@gardena.se

Switzerland / Schweiz

Husqvarna Schweiz AG
Consumer Products
Industriestrasse 10
5506 Mägenwil
Phone: (+41) (0) 62 887 37 90
info@gardena.ch

Turkey

GARDENA Dost Diş Ticaret
Mümessillik A.Ş.
Sanayi Çad. Adil Sokak
No: 1/B Kartal
34873 Istanbul
Phone: (+90) 216 38 93 939
info@gardena-dost.com.tr

Ukraine / Україна

ТОВ «Хусварна Україна»
вул. Васильківська, 34,
офіс 204-р
03022, Київ
Тел. (+38) 044 498 39 02
info@gardena.ua

Uruguay

FELI SA
Entre Rios 1083 CP 11800
Montevideo - Uruguay
Tel: (+598) 22 03 18 44
info@felisa.com.uy

Venezuela

Corporación Casa y Jardín C.A.
Av. Caroní, Edif. Trezmen, PB.
Colinas de Bello Monte.
1050 Caracas.
Tlf: (+58) 212 992 32 22
info@casayjardin.net.ve

1251-20.960.18/0414
© GARDENA
Manufacturing GmbH
D-89070 Ulm
http://www.gardena.com